

TYPE JHC High Current Micro Fuse is designed for the purpose of external short circuit protection of the lithium ion battery of medium sizes, such as a power tool and an electric assistant bicycle.

Though it was a surface mount type, it was small and realized high current rating, because a fuse element and a terminal adopt the structure of one.

Furthermore perfectly compliant to Lead-free makes environment friendly design.

FEATURES

1. High current rating was realized because a fuse element and a terminal adopt the structure of one.
2. Surface mount type and small size of 7358 (7.3mm × 5.8mm × 4.2mm) and 1173 (11.0mm × 7.3mm × 5.9mm).
3. Surface temperature rise is 75°C or less when applying rated current. This gives little influence to the peripheral units.
4. Alumina ceramics are adopted as a case, original structure is adopted as the inside of a case, and the safety at the time of fusing is improved.
5. Suitable for automatic mounting
6. Complete lead-free

APPLICATION CLASSIFICATION BY USE

The application classification by use which divided the market and use into four is set up supposing our products being used for a broad use.

Please confirm the application classification by use of each product that you intend to use.

Moreover, please be sure to inform to our Sales Department in advance in examination of the use of those other than the indicated use.

Market	Application classification by use	Use		Recommendation Type
		Outline	Typical example of application	Circuit Protection Components
High reliability apparatus	1	- Apparatus in which advanced safety and reliability are demanded. - Whether failure of the apparatus which cannot maintenance exchange products, and a product is direct for a human life, apparatus which changes or may cause a fatal system failure.	- Space development apparatus relation (Satellite, Rocket, Artificial Satellite) - Aviation and a defensive system - Atomic power, fire power, and a water-power generation system	With no relevance
In-vehicle Industrial apparatus	2	- Apparatus in which reliability is important. - The apparatus in which maintenance exchange of a product is very difficult, and failure of a product influence a human life, or the range of failure is wide range.	- Vehicles control of transport machines, such as a car, and a railroad, a vessel (Engine control, drive control, brake control) - The operation control system of the Shinkansen and a main artery	Type KAB N series Type JAG N series Type KVA N series
	3	-Apparatus which can maintenance exchange products, and apparatus in which the loss of the system failure is large although failure of a product does not influence a human life, and maintenance engineering is demanded	- Vehicle indoor loading parts, such as an air-conditioner and car navigation, and in-vehicle communication facility - Security management system for home/buildings etc. - Control apparatus, such as Industrial use robots and a machine tool etc.	Type KAB M series
Apparatus in general	4	- The small size and the thin article which applies leading-edge technology positively - The product supposing being used widely in the market for the apparatus which can maintenance exchange products, and apparatus with a partial system failure by failure of product	-Smart phone, Mobile phone, Mobile PC (tablet), Electronic dictionary - Desktop PC, Notebook PC, Home network - Amusement apparatus (Pachinko, Game machine)	Type KAB Type KAB T series Type KAH Type JAE, Type JAG Type JAH, Type JAH L series Type JHB, Type JHC, Type JHC H series Type KVA

RATING

Item	Rating
Category Temperature Range	-40 ~+125°C
Rated Current	30A, 40A, 50A, 60A, 80A, 100A
Rated Voltage	35VDC, 60VDC, 84VDC
Voltage Drop	Refer to CATALOG NUMBERS AND RATING
Insulation Resistance (between terminals and case)	1000MΩ or more
Fusing Characteristics	Fusing within 1 minute if the current is 250% of rated current.
Clearing Characteristics	Breaking voltage : Rated Voltage
	Breaking Current : 300A, 600A

ORDERING INFORMATION

Type	Code	Voltage	Code	Rated current	Code	Rated current	Code	Package type	Code	Case size
JHC	3502	35V	303	30 A	603	60 A	R	φ 180 Reel	44E	7.3×5.8
	6002	60V	403	40 A	803	80 A	N	φ 330 Reel	59F	11.0×7.3
	8402	84V	503	50 A	104	100 A				

CATALOG NUMBERS AND RATING

Jul. 2018

Catalog number	Case size	Rated current A	Internal resistance mΩ (Typical)	Voltage drop mV (Max.)	Rated voltage VDC	Breaking current A	
JHC 3502 303 □ 44E	7.3×5.8	30	1.38	80	35	300	
JHC 6002 303 □ 44E					60		
JHC 3502 403 □ 44E		40	1.08		35		
JHC 6002 403 □ 44E					60		
JHC 3502 503 □ 44E		50	0.85		35		
JHC 6002 503 □ 44E					60		
JHC 3502 603 □ 44E		60	0.74	90	35		600
JHC 6002 603 □ 44E					60		
JHC 3502 803 □ 44E		80	0.56		35		
JHC 3502 104 □ 44E					100		
JHC 8402 303 □ 59F *1)	11.0×7.3	30	1.46	80	84	300	
JHC 8402 403 □ 59F *1)							
JHC 8402 503 □ 59F *1)		50	0.88				90
JHC 8402 603 □ 59F *1)							
JHC 6002 803 □ 59F		80	0.55		60		600
JHC 6002104 □ 59F							

- For the taping type, the packing code "R or N" will be entered in □. For 59F, only "N" will be entered in □.
- Catalog numbers are approved by UL. cUL.(File No.E170721,E480488)
- *1): to be approved by UL,cUL

DIMENSIONS

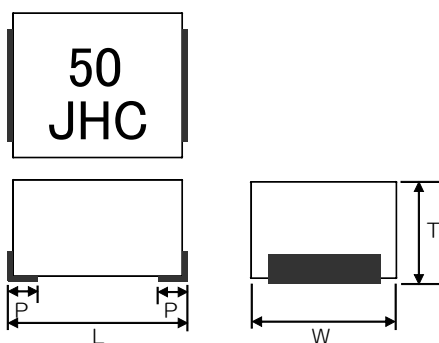

Main body : Ceramic case

Terminal : Tin plating

(mm)

Case size	Case code	L	W	T	P
7358	44E	7.3±0.3	5.8±0.2	4.2±0.2	1.2±0.3
1173	59F	11.0±0.3	7.3±0.3	5.9±0.2	1.8±0.3

MARKING

Code : Rated current	Code : Rated current
30 : 30A	60 : 60A
40 : 40A	80 : 80A
50 : 50A	100 : 100A

CONSTRUCTION

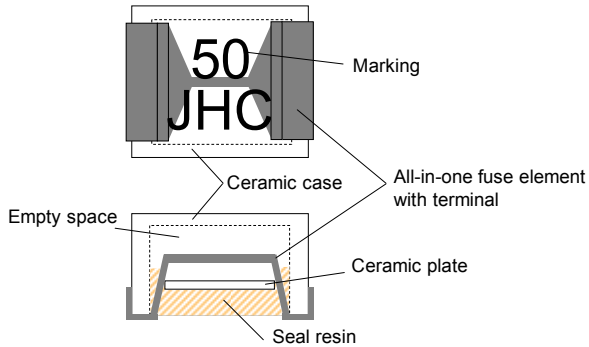

Name	Material, standard, and treatment
All-in-one fuse element with terminal	Copper Alloy (Tin plating terminal)
Ceramic case	Alumina ceramics
Ceramic plate	Alumina ceramics
Seal resin	Silicone resin
Marking	UV curable resin
Empty space	—

RECOMMENDED PAD DIMENSION

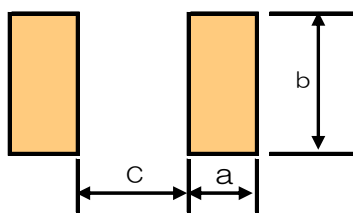

(mm)

	Size 7358	Size 1173
a	2.7	3.3
b	5.8	7.3
c	4.4	6.9

(Reflow)

STANDARD TEST BOARD

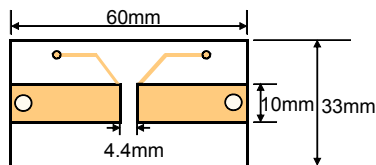

Glass epoxy body on one side
Board thickness : 1.6mm
Thickness of Copper layer : 400µm
Rated Current : 30~50A

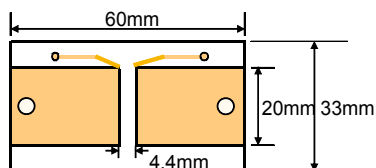

Glass epoxy body on one side
Board thickness : 1.6mm
Thickness of Copper layer : 500µm
Rated Current : 60~100A

PERFORMANCE

No	Item	Performance	Test method
1	Temperature rise	Temperature rise shall not exceed 75°C	Apply rated current
2	Current-carrying capacity	Shall not open within 1 hour.	Apply 100% of rated current
3	Clearing characteristics	Arc shall not be continued. No ignition. Marking shall be legible No bursting of the fuse	Breaking voltage : Rated voltage Breaking current : 300A(30~50A) , 600A(60~100A)
4	Voltage drop	Voltage drop is below the value specified in CATALOG NUMBERS AND RATING.	Apply rated current
5	Fusing characteristics	Fusing within 1 min.	Apply 250% of rated current (Ambient temperature: 10~30°C)
6	Insulation resistance	1000MΩ or more	Insulation resistance between terminals and case(ceramics)
7	Electrode strength (Bending)	No mechanical damage. Resistance change after the test shall be within ± 20%.	Board supporting width : 90mm Bending speed : Approx. 0.5mm/s Duration : 5 s Bending : 3mm
8	Shear test	No mechanical damage. Resistance change after the test shall be within ± 20%.	Applied force : 20N Duration : 10s Tool : R0.5 Direction of the press : side face
9	Core body strength	No mechanical damage. Resistance change after the test shall be within ± 20%.	Supporting dimension : 3.65mm Applied force : 20N Duration : 10s Tool : R0.5 Direction of the press : thickness direction of product
10	Solderability (Solder Wetting time)	Solder Wetting time : within 3s	Solder : Sn-3Ag-0.5Cu Temperature : 245±5°C meniscograph method
11	Solderability (new uniform coating of solder)	The dipping surface of the terminals shall be covered more than 95% with new solder.	Solder : Sn-3Ag-0.5Cu Temperature : 245±5°C Dipping : 3s
12	Resistance to soldering heat	Marking shall be legible. No mechanical damage. Resistance change after the test shall be within ± 20%.	Dipping (1 cycle) Preconditioning : 100~150°C / 60s Temperature : 265±3°C / 6~7s Reflow (2 cycle) Preconditioning : Lower than 180°C 1~2min Peak : 250±5°C 5s Holding : 230~250°C 30~40s Cooling : More than 2min Manual soldering (2 cycle) Temperature : 350±10°C Duration : 3~4s Measure after 1hour left under room temperature and humidity.
13	Solvent resistance	Marking shall be legible. No mechanical damage. No significant irregularity in the appearance.	Dipping rinse Solvent : Isopropyl alcohol Duration : 90s
14	Vibration	No mechanical damage. Resistance change after the test shall be within ± 20%.	Frequency rage : 10~55~10Hz/min Vibration amplitude : 1.5mm Duration : 2 hours in each of XYZ directions (total : 6 hours)
15	Shock	No mechanical damage. Resistance change after the test shall be within ± 20%.	Peak value : 490m/s ² Duration : 11ms 6 aspects × 3 times (total: 18 times)
16	Thermal shock	No mechanical damage. Resistance change after the test shall be within ± 20%.	-55±3°C : 30min Room temperature : 2~3min or less 125±2°C : 30min Room temperature : 2~3min or less Repeat above step for 10 cycles
17	Moisture resistance	No mechanical damage. Resistance change after the test shall be within ± 20%.	Temperature : 85±3°C Humidity : 85±5%RH Duration : 1000h
18	Load life	No mechanical damage. Resistance change after the test shall be within ± 20%.	Temperature : 85±2°C Applied current : Rated current×70% Duration : 1000h
19	Moisture resistance load	No mechanical damage. Resistance change after the test shall be within ± 20%.	Temperature : 85±3°C Humidity : 85±5%RH Applied current : Rated current×70% Duration : 1000h
20	Stability	No mechanical damage. Resistance change after the test shall be within ± 20%.	Temperature : 125±2°C Duration : 1000h

FUSING CHARACTERISTICS

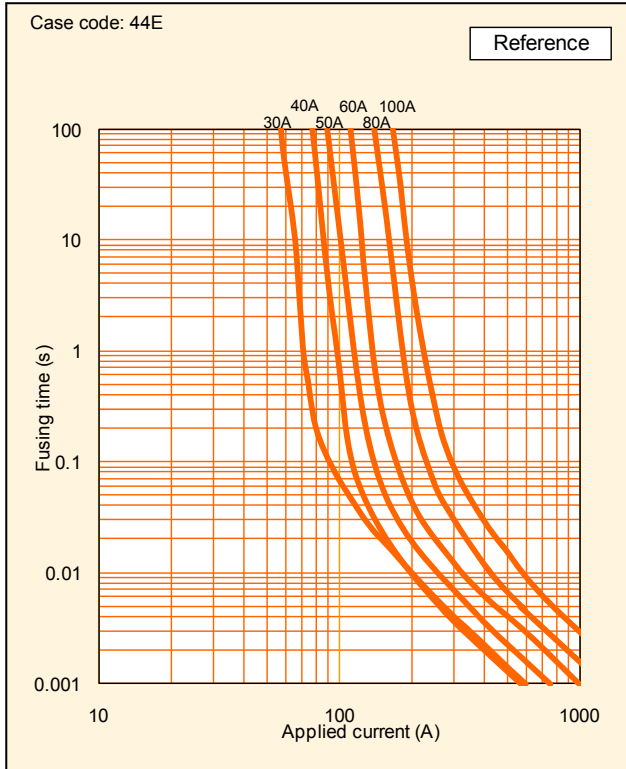

I²T - T CHARACTERISTICS

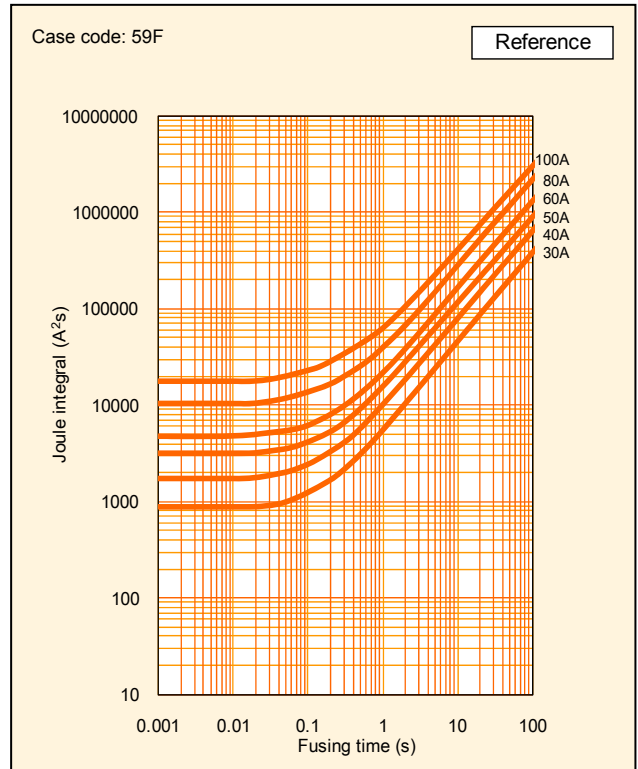
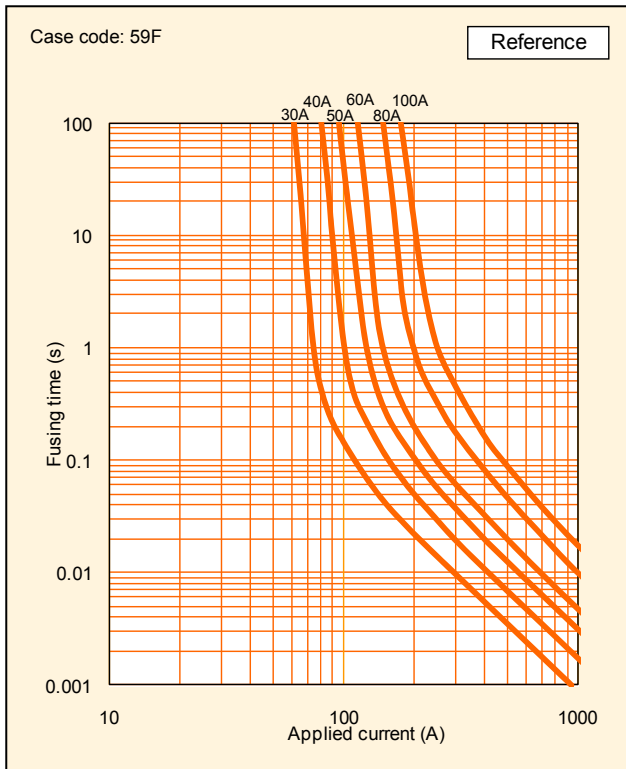
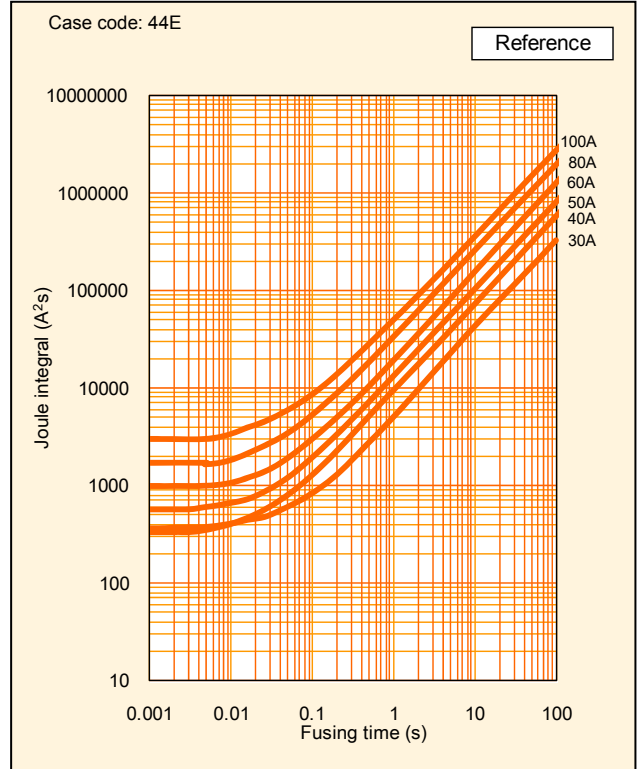

DISTRIBUTION OF FUSING CHARACTERISTICS

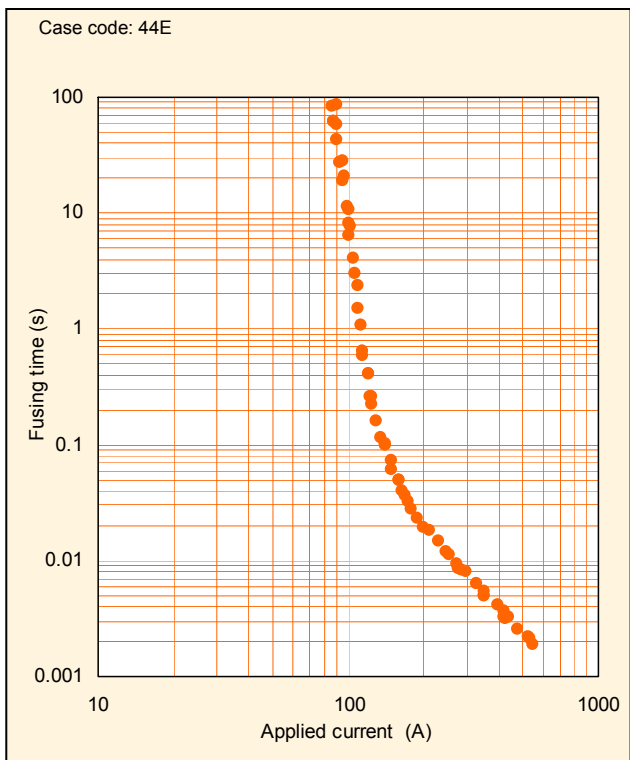

DISTRIBUTION OF FUSING TIME

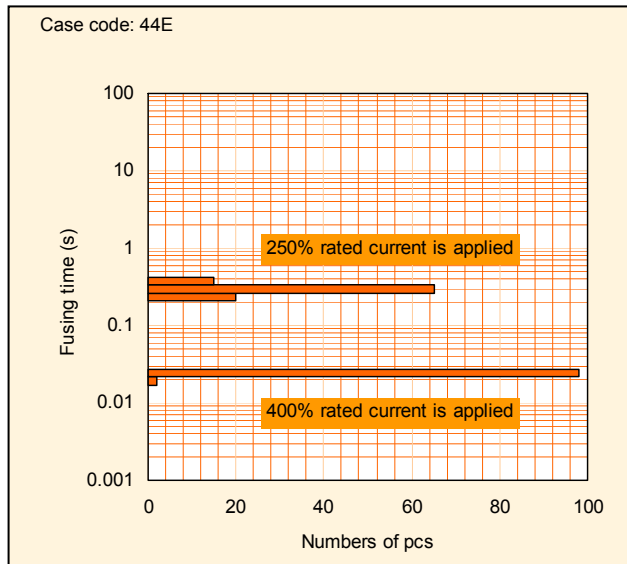

DETERMINATION OF RATED VALUE AND SELECTION OF MICRO FUSE (TYPE JHC)

Determine the rated value of the micro fuse, and select the micro fuse for your circuit. If you select the micro fuse, safety of your circuit can be ensured.

How to determine the rated value of the micro fuse is described below:

■ Flow for fuse selection

1. Measurement of circuit values using actual device

Measure the circuit values, such as operating current of the circuit.

2. Calculation from operating current

From the obtained operating current and the category temperature, calculate minimum rated value to determine the applicable fuse.

3. Calculation from overload current

From the obtained overload current, calculate the maximum rated value to determine the applicable fuse.

4. Calculation from inrush current

From the inrush current, calculate the minimum rated value to determine the applicable fuse.

5. Final determination of rated value

From the calculation results of steps 2 through 4, determine the rated value.

6. Operation check using actual device

After selecting the rating, confirm if the device works properly under the pre-determined conditions.

■ Fuse selection

1. Measurement of circuit values using actual device

Before determining the rated value of the fuse, preliminarily measure the following condition by using the actual device.

1-1. Operating current

Using an oscilloscope or equivalents, measure operating current of the circuit.

1-2. Overload current

Using an oscilloscope or equivalents, measure the overload current that needs to break the circuit.

1-3. Inrush current

Using an oscilloscope or equivalents, measure the inrush current of circuit at power-on or power-off. In addition, determine the number of inrush current applied.

1-4. Category temperature

Measure the ambient temperature of the fuse circuit.

<The notes to the design of substrate wiring>

In a 25°C environment under normal circumstances, please design substrate wiring so that the surface temperature of a fuse does not exceed 80°C.

EXAMPLE TO SELECT RATINGS OF TYPE JHC

<Fuse selection>

Effective operating current : 30 A

Effective overload current : 140 A

Inrush current waveform : Fig. A

(Pulse width : 2 ms, Wave height : 300 A)

Numbers to withstand inrush current : 100,000 times

Category temperature : 85°C

Operating time : 4,000h

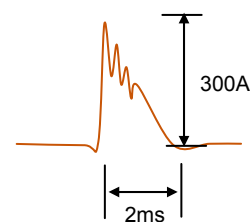

Fig. A : Inrush current waveform

2. Calculation from operating current

2-1. Measurement of operating current

Using an oscilloscope or equivalents, measure operating current (effective current) of the actual circuit.

Example : Effective operating current = 30 A

2-2 Derating

① Temperature derating factor

Using Fig. B, find the temperature derating factor correspond to the Temperature.

However, in order to be allowed to check an operating condition in use to the apparatus used for a long time that the operating time exceeds 4,000 h, please ask our Sales Department.

② Rated derating factor

Rated derating factor = 0.94 (Constant irrespective of temperature)

Use Formula 1 to calculate the rated current of the fuse to be used for the circuit.

Rated current of fuse \geq Operating current / (① × ②) ... Formula 1

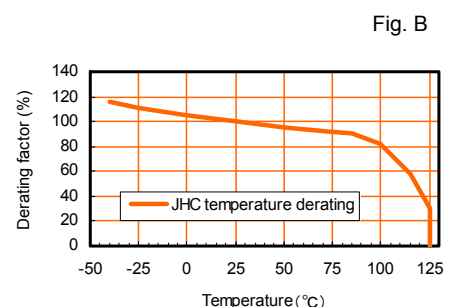

Fig. B

Example : Category temperature = 85°C, Operating current =30 A

- ① Temperature derating factor = 0.90 (Refer to Fig. B.)
- ② Rated derating factor = 0.94 (Constant irrespective of temperature)

Calculation using Formula 1 :

$$\text{Rated current} \geq 30 / (0.90 \times 0.94) = 35.5\text{A}$$

The above calculation result shows that the fuse with rated current of 35.5A or more should be selected for this circuit.

Type JHC, with rated current of 50 A and 40A can be selected.

3. Calculation from overload current

3-1 Measurement of overload current

Using oscilloscope or equivalents, measure overload current that needs to break circuit.

Example : Effective overload current = 140 A

3-2 Calculation from overload current

Determine rated current so that overload current can be 2.5 times larger than rated current.

Use Formula 2 to calculate rated current of fuse.

Rated current of fuse \leq Overload current/2.5 ... Formula 2

Example : Overload current = 140 A

Use Formula 2 to calculate the rated current.

$$\text{Rated current} \leq 140 / 2.5 = 56\text{ A}$$

The above calculation result shows that the fuse with rated current of 56 A or less should be selected for this circuit.

Type JHC, with rated current of 50 A and 40A can be selected.

4. Calculation from inrush current

4-1 Measurement of inrush current waveform

Using an oscilloscope or equivalent, measure waveform of inrush current of actual circuit.

4-2 Creation of approximate waveform

Generally, waveform of inrush current is complicated. For this reason, create the approximate waveform of inrush current as shown on Fig. C to simplify calculation.

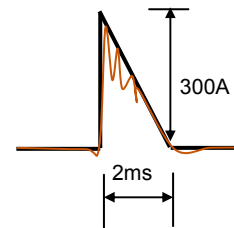

Fig. C : Inrush current waveform
Red line : Actual measurement waveform
Black line : Approximate waveform

4-3 Calculation of I^2t of inrush current

Calculate I^2t (Joule integral) of approximate waveform.

The formula for this calculation depends on the approximate waveform.

Refer to Table A.

Example : Pulse applied = 2 ms, Peak value = 300 A

Approximate waveform = Triangular wave

Since the approximate waveform is a triangular wave, use the following formula for calculation.

$$I^2t \text{ of rush current} = 1/3 \times I_m^2 \times t \dots \text{Formula 3} \quad (I_m : \text{Peak value, } t : \text{Pulse applying time})$$

Use Formula 3 to calculate I^2t of the inrush current:

$$I^2t = 1/3 \times 300 \times 300 \times 0.002 = 60 \text{ (A}^2\text{s)}$$

JOULE-INTEGRAL VALUES FOR EACH WAVEFORM

Table A

Name	Waveform	I^2t	Name	Waveform	I^2t
Sine wave (1 cycle)		$\frac{1}{2} I_m^2 t$	Trapezoidal wave		$\frac{1}{3} I_m^2 t_1 + I_m^2 (t_2 - t_1) + \frac{1}{3} I_m^2 (t_3 - t_2)$
Sine wave (half cycle)		$\frac{1}{2} I_m^2 t$	Various wave 1		$I_1 I_2 t + \frac{1}{3} (I_1 - I_2)^2 t$
Triangular wave		$\frac{1}{3} I_m^2 t$	Various wave 2		$\frac{1}{3} I_1^2 t_1 + [I_1 I_2 + \frac{1}{3} (I_1 - I_2)^2] (t_2 - t_1) + \frac{1}{3} I_2^2 (t_3 - t_2)$
Rectangular wave		$I_m^2 t$	Charge/ discharge waveform		$\frac{1}{2} I_m^2 \tau$

* Following formula is generally used for calculation of I^2t as $i(t)$ equal to current.

$$I^2t = \int_0^t i^2(t) dt$$

4-4 Search of load ratio

- ① Set up number of cycles to withstand.
(generally 100,000 times)
- ② Obtain load ratio from Pulse resistance characteristics.
(Fig. D)

Example : 100,000 times is required against inrush current applied.

The load ratio is 35% or less from Fig. D.

PULSE RESISTANCE CHARACTERISTICS

Fig. D

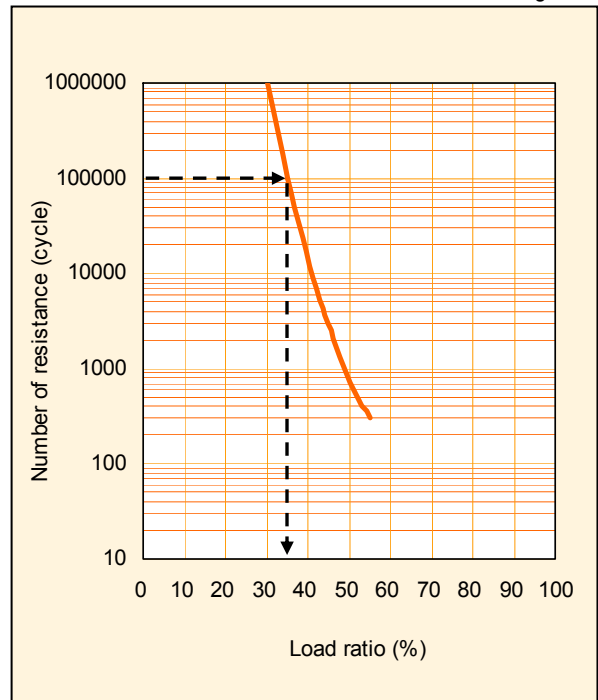

4-5 Calculation from Joule integral and load ratio

Use Formula 4 to calculate the standard I^2t for the fuse to be used.

Standard I^2t of fuse > (I^2t of inrush current/load ratio)
.....Formula 4

Example : I^2t of pulse = 60 A²s,
Pulse applied = 2 ms, Required load ratio = 35%

From Formula 4,
Standard I^2t of fuse > $60/0.35 = 171.4$ (A²s)
The standard I^2t of the fuse should be 171.4 (A²s) or more.
Since the rush pulse applied is 2 ms, obtain the intersection of 2 ms (horizontal axis) and 171.4 A²s (vertical axis) from Fig. E (refer to the arrow shown in Fig. E).
Select a fuse whose curve is above the intersection. Type JHC with rated current of 50 A and 40A should be selected.

JOULE INTEGRAL VS. FUSING TIME

Fig. E

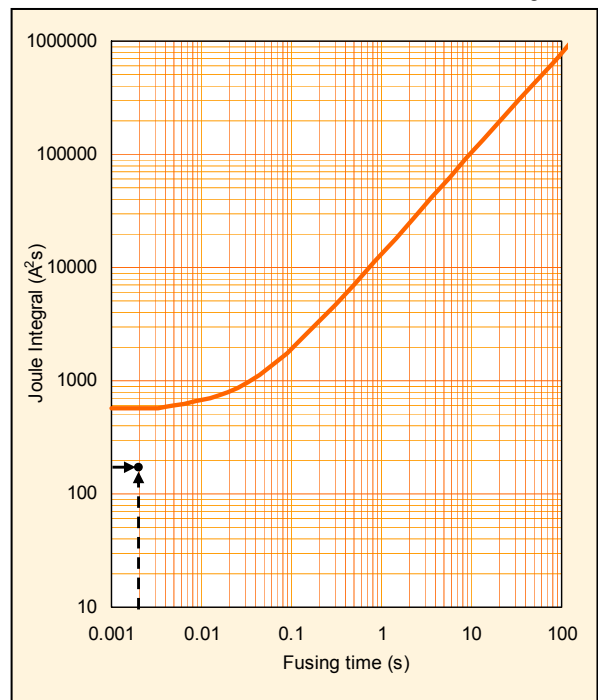

5. Final determination of rated value

Determine the rated current of micro fuse. Rated current should meet all the calculation results.

Example : Rated current of 50 A and 40A meets the all requirement.

6. Operation check using actual device

After selecting rating, confirm if the device works properly under pre-determined conditions.



Application Notes for Micro Fuse

1. Circuit Design

HIGH CURRENT MICRO FUSE should be designated only after confirming operating conditions and Micro Fuse characteristics.

When determining the rated current, be sure to observe the following items :

- (1) HIGH CURRENT MICRO FUSE should always be operated below the value considered in the rated derating rate and temperature derating rate for rated current.
- (2) HIGH CURRENT MICRO FUSE should always be operated below the rated voltage.
- (3) HIGH CURRENT MICRO FUSE should be selected with correct rated value to be fused at overload current.
- (4) When HIGH CURRENT MICRO FUSE are used in inrush current applications, please confirm sufficiently inrush resistance of Micro Fuse.
- (5) Please do not apply the current exceeding the breaking current to HIGH CURRENT MICRO FUSE. In addition, I would like confirmation beforehand not to have possibilities to cut if off normally when you uses it by a high inductance circuit.
- (6) Use HIGH CURRENT MICRO FUSE under the condition of category temperature.
- (7) HIGH CURRENT MICRO FUSE should not be used in the AC power source and primary power source.
- (8) HIGH CURRENT MICRO FUSE should be selected by determining the operating conditions that will occur after final assembly, or estimating potential abnormalities through cycle testing.
- (9) In a 25 °C environment under normal circumstances, please design substrate wiring so that the surface temperature of a fuse does not exceed 80 °C.

And, please use after checking that turn on operating current and overload current by an actual substrate in advance, and it is satisfactory.

2. Assembly and Mounting

During the entire assembly process, observe Micro Fuse body temperature and the heating time specified in the performance table.

In addition, observe the following items :

- (1) Mounting and adjusting with soldering irons are not recommendable since temperature and time control is difficult.
- (2) Once Micro Fuse mounted on the board, they should never be remounted on boards or substrates.
- (3) During mounting, be careful not to apply any excessive mechanical stresses to HIGH CURRENT MICRO FUSE.

3. Solvents

For cleaning of Micro Fuse, immersion in isopropyl alcohol for 90 seconds (at 20 ~ 30°C liquid temp.) will not be damaged.

If organic solvents (Pine Alpha™, Techno Care™, Clean Through™, etc.) will be applied to HIGH CURRENT MICRO FUSE, be sure to preliminarily check that the solvent will not damage HIGH CURRENT MICRO FUSE .

4. Ultrasonic Cleaning

Ultrasonic cleaning is not recommended for HIGH CURRENT MICRO FUSE. This may cause damage to HIGH CURRENT MICRO FUSE such as broken terminals which results in electrical characteristics effects, etc. depending on the conditions.

5. Caution During Usage

- (1) HIGH CURRENT MICRO FUSE with electricity should never be touched. HIGH CURRENT MICRO FUSE with electricity may cause burning due to HIGH CURRENT MICRO FUSE high temperature.

Also, in case of touching HIGH CURRENT MICRO FUSE without electricity, please check the safety temperature of HIGH CURRENT MICRO FUSE.

- (2) Protective eye glasses should always be worn when performing fusing tests.

However, there is a fear that HIGH CURRENT MICRO FUSE will explode during test. During fusing tests, please cover particles not to fly outward from the board or testing fixture. Caution is necessary during usage at all times.

6. Environmental Conditions

- (1) HIGH CURRENT MICRO FUSE should not be stored or operated in the presence of acids, or alkalis, or corrosive atmosphere.
- (2) HIGH CURRENT MICRO FUSE should not be vibrated, shocked, or pressed excessively.
- (3) HIGH CURRENT MICRO FUSE should not be operated in a flammable or explosive atmosphere.
- (4) HIGH CURRENT MICRO FUSE should not be used under dew condensation environment.

7. Emergency

In case of fire, smoking, or offensive odor during operation, please cut off the power in the circuit or pull the plug out.

8. Storage

- (1) HIGH CURRENT MICRO FUSE should be stored at room temperature (-10°C ~ +40°C) without direct sunlight.

HIGH CURRENT MICRO FUSE should not be stored in corrosive atmosphere such as H₂S (hydrogen sulfide) or SO₂(sulfur dioxide) . Direct sunlight may cause decolorization and deformation of the exterior and taping.

Also, there is a fear that solderability will be remarkably lower in high humidity.

- (2) If the products are stored for an extended period of time, please contact Matsuo Sales Department for recommendation. The longer storage term causes packages and tapings to worsen. If the products are stored for longer term, please contact Matsuo Sales Department for advice.
- (3) The products in taping, package, or box should not be given any kind of physical pressure. Deformation of taping or package may affect automatic mounting.

9. Disposal

When HIGH CURRENT MICRO FUSE are disposed of as waste or "scrap", they should be treated as "industrial waste".

10. Samples

HIGH CURRENT MICRO FUSE received as samples should not be used in production applications. A sample is provided for the special use (in such cases as the one for the form sample, the electric characteristic confirmation)



MATSUO ELECTRIC CO., LTD.

Please feel free to ask our sales department for more information on Micro Fuse.

Overseas Sales	5-3,3-Chome, Sennari-cho, Toyonaka-shi, Osaka 561-8558, Japan	Tel:06-6332-0883 Fax:06-6332-0920
Head office	5-3,3-Chome, Sennari-cho, Toyonaka-shi, Osaka 561-8558, Japan	Tel:06-6332-0871 Fax:06-6331-1386
URL	http://www.ncc-matsuo.co.jp/	

The specifications on this catalog are subject to change without prior notice. Please inquire of our Sales Department to confirm the specifications prior to use.