

ELECTRICAL MACHINES



EIPRESS®

GB

etech
components

Business aim

“The business aim of the Elpress Group is to provide, primarily to professional Nordic and global users, qualified material and knowledge concerning electrical applications, with a high level of service and product expertise.”

Contact us

Head office

Elpress AB

Industrivägen 15
P.O. Box 186
SE-872 24 Kramfors, Sverige
Tel +46 612 71 71 00
sales@elpress.se

Customer support

Tel +46 612 71 71 70
support@elpress.se

Order

Tel +46 612 71 71 70
order@elpress.se

Sales offices/subsidiaries

Elpress GmbH

Kränkelsweg 24
DE-417 48 Viersen, Germany
Tel +49 2162 93 19-0
Fax +49 2162 350403
sales@elpress.de
www.elpress.de

Elpress A/S

Randersvej 16
DK-8600 Silkeborg, Denmark
Tel +45 8681 61 11
salg@elpress.dk
www.elpress.dk

Elpress Inc.,

900 Oakmont Lane, Suite 207,
Westmont IL 60559 USA
Tel: +1-331-814 2915
Fax: +1-331-814 2914
sales@elpress.us
www.elpress.us

Elpress (Beijing)

Electrical Components Co., Ltd
Rm 1605, Diyang Tower,
No. H2 DongsanhuanBei Lu,
Chaoyang District,
Beijing 100027, P.R. China
Tel:+86 10 5979 6187
Fax:+86 10 6438 5279
info@elpress.com.cn
www.elpress.com.cn

Elpress has been developing, manufacturing and marketing complete cable crimping systems for electrical connectors since 1959.

The Elpress Group, consisting of the Elpress and ABIKO business areas is owned by Lagercrantz Group AB. Elpress head office and factory is located in Kramfors, Sweden. Subsidiaries Elpress GmbH, Elpress A/S and Elpress (Beijing) Ltd. and Elpress Inc. with local warehouses in Viersen/Germany, Silkeborg/Denmark, Beijing/China and Chicago/USA.

The information contained in this catalogue is for commercial use to select products only. It is not intended for use in QA instructions, production drawings, instruction manuals or likewise. If such documentation is required, please contact your nearest Elpress representative or Elpress directly. Although every effort has been made to ensure correct and updated information at time of printing, Elpress makes reservation for misprints, wrong or outdated information and changes. Elpress reserve the right to change, update or discontinue products without prior notice.

This catalogue is the property of Elpress. Any reproduction in full, part or of pictures, is forbidden without prior written permission from Elpress AB.

Certification and standards



Environment policy

Within ELPRESS AB we shall always work with ongoing improvements reducing our influence on the environment. This shall be achieved by using resources in an environment promoting way and by reducing the amount of emissions and waste. We shall meet the legal requirements with a good margin. Our products shall be designed to minimise environmental influence related to

- Manufacture
- Use
- Final disposal

All ingredients, materials and components with a negative environment influence shall gradually be exchanged. Our processes as well as our places and methods of work shall be designed and adapted in order to minimise environmental influence and to avoid injury and health hazard to persons.

Information and training shall constitute normal activities in the company to stimulate interest in environment issues with all ELPRESS' employees and to support personal development and participation in the environment work of the company.

Our suppliers and commissioned partners shall be chosen and influenced in such a way that they can add to our fulfilment of the environment policy.

Our customers shall be informed of our environment work and form co-operation partners to spread knowledge and advice to the parties of the distribution chain, all in order to safeguard the proper use, stocking and final disposal of our products.

We shall continuously evaluate the results of the environment work. We shall demonstrate openness concerning information on our work and our effect on the environment.

Our environment work has resulted in Elpress being certified to ISO 14001:2004 since 2004.

Our certificate, with number EMS 531083, is issued by the internationally recognized BSI, British Standards Institution, of England.



Quality

For us, quality means trying all the time to be the best in the business. That's why we are constantly developing our products, methods and ourselves, since knowledge is perhaps the most important component for achieving the highest quality. Our work on quality has resulted in Elpress being certified to ISO 9001 since 1992.

Our certificate, with number FM20987, is issued by the internationally recognized BSI, British Standards Institution, of England.

Verification of products

There are quite a lot of different test standards and approval routines that may be applied on cable connectors and terminations. Due to this and the variation in contents between standards from different countries one has to make a selection. Elpress had previously applied primarily Swedish, UK and German standards but lately IEC and EN Standards, where the latter rapidly will substitute the old national standards. In many cases there are also reason for special approvals like Det Norske Veritas, UL and others.



IEC - International Electrical Commission - issues international standards which, although not always compulsory, do have strong influence and are used as a basis within the international terminal trade.



DNV - Det Norske Veritas

Elpress KRF/KSF, KRT/KST terminals comply with DNV's rules for the classification of ships and Det Norske Veritas' Offshore Standards. The terminals are approved for installations on ships and mobile offshore units.



UL is an American standard which is also internationally accepted. Elpress standard Cu terminals of types KR/KS, KRF/KSF and KRT/KST, are UL approved according to no. E205350. Cu terminals of types KR/KS, KRF/KSF are for stranded and flexible copper wires, classes 2 and 5 according to IEC 60228, and have a working area of 1-500 mm². Cu terminals of types KRT/KST is used for stranded copper wires 10-500 mm².

TABLE OF CONTENT

Advanced crimping makes reliability, high performance and documentation essential	2
Tube terminals 16 - 630 mm ²	4
Tube terminals 90°, 25 - 400 mm ²	5
Tube terminals 45°, 25 - 400 mm ²	6
Tube terminals with two stud holes 50 - 630 mm ²	7
Tube terminals with two stud holes (one oval) 50 - 240 mm ²	7
Tube terminals 90° with 2 holes, 150 - 630 mm ²	8
Tube terminals 90° with 2 holes (one oval), 70 - 240 mm ²	8
Through connectors 16 - 630 mm ²	9
Reducer through connectors 35 - 630 mm ²	10
Parallel through connectors, winding to flexible conductor 50 - 240 mm ²	11
T-connectors with different area 25 - 500 mm ² , KTSF	12
T-connectors 35 - 400 mm ² , 110°, KTSF	13
T-connectors 35 - 630 mm ² , KTSF	13
Tube terminals 0,75 - 10 mm ² , KR	14
Through connectors 0,75 - 10 mm ² , KS	14
KRFS tube terminal 50 - 400 mm ² with extra narrow palm	15
Parallel through connectors 20 - 630 mm ² , KS-P	16
CUT through connectors for solid conductors 6 - 16 mm ²	16
DIN 46235 tube terminals 6 - 1000 mm ²	17
Al-Cu bimetallic through connectors 10 - 240 mm ²	18
Al-Cu terminals 16 - 1200 mm ²	19
Flat, flexible braids	20
Flat, flexible braids (tin plated)	20
Round, flexible connections (un-insulated)	20
Round, flexible connections (un-insulated, tin plated)	21
Round, flexible connections (insulated)	21
Manual crimping tools for off-load transformer tap changers (ES2258LB5/ ES2258LB7)	23
Manual crimping tools for Cu connectors (DKB0325 / DKB0760 / GWB4099 and GWB4099C)	24
ES2258 / T2258	25
Battery powered crimp tool for crimping off-load transformer tap changers (PVL130L)	26
System 600 for crimping Cu and Al terminals (V600/ V611)	27
PVX611/PVX611DB	28
Accessories for system 600	29
System 1300 for crimping Cu and Al terminals (V1300 / V1300L)	31
PVX1300/PVX1300DB / V1300C2	32
PVX1300C2/PVX1300C2DB	33
Accessories for system 1300	34
System V250 for crimping Cu and Al terminals (DV250 / V250L)	37
Accessories for system 250	38
System V350 for crimping Cu-terminals (DV350)	40
Accessories for system 350	41
System V1470 for crimping Cu and Al terminals (V1470)	42
Accessories for system 1470	43
Hydraulic pumps (PS710 / PS710E)	44
PS710R / PS710E251 and PS710E501* / PS710R250 and PS710R500*	45
Accessories for PS710x	46
Battery powered cable cutter (PCT54C)	47
Cable cutter up to ø50 mm (HKS50)	48
Hydraulic cable cutters (KL2585, HKL40/KL40, HKL55/KL55, HKL85/KL85)	50

Advanced crimping makes reliability, high performance and documentation essential



Crimping system

When crimping in advanced applications as transformers it is essential that the crimping system is a high performance and reliable system. Elpress has developed a wide range of products specialized for these applications. Together with training of operators, certifications and the products this is a complete system concept. Elpress Crimp System for Transformer connections is:

- Terminals and connectors adapted to transformer use
- Electrically powered crimp tools with ergonomic crimp heads, rounding and crimp dies
- Test certification to international standards
- Production quality procedures
- Training and certifying of operators



Terminals and connectors

Elpress complete system consists of terminals and connectors from 25 to 630 mm². They have the suffix L which is the customers' guarantee that the connectors are a part of the quality assured system. Special items have been developed, like the straight and angled T-connectors. Markings on the terminals and connectors show tool identification, size, stud hole and manufacturers emblem. The markings are made for easier and correct use.

Tools

With the 13 and 25 tons crimp heads Elpress ensures easy operation both when rounding of winding bundles and when crimping. Elpress offers a mains and/or battery operated hydraulic pump that is controlled from the crimping head handle and powers the crimping head. Rounding and crimping dies are polished for minimising the risk of sharp edges. Winding connections are crimped within the following acceptance range for each connection.

Nominal connector area mm², winding conductor mm²

Nom. connector area	Tot. initial real winding conductor cross section	Tot. initial real winding conductor cross section
mm ²	min mm ²	max mm ²
25	30	47
35	45	70
50	69	103
70	100	120
95	113	161
120	145	185
150	180	220
185	220	265
240	302	343
300	340	400
400	412	500
500	500	580
630	600	730

Tests

Elpress has tested the use of terminals and connectors within the specified cross section area ranges in accordance with IEC 61238-1. This is the most widely accepted test standard with a qualified evaluation of performance stability. Test reports are available from Elpress and can be requested if needed.

Product quality assurance

It is essential to have simple means of identifying correct crimp procedures and results while working. With the Elpress System the dies leave an imprint on the crimped barrel surface showing the die identification. This enables a direct and easy inspection that proper tools have been used. For all crimps a crimp height limit is given to make an easy check of proper tool function by means of a vernier caliper or a gauge.

Operator training

To ensure that operators have the detailed knowledge that is the base for long term quality, Elpress runs theoretical and practical training sessions at each production site resulting in certification of the individual operators. These trained operators will have a qualified level in regard to practical work procedures as well as the precautions that ensure proper results. Please contact Elpress for more information.



Assured results

When you work with the Elpress Crimp System for Transformer Conductor Connections, and follow the instructions for this system, you get results which have been tested to well established standards and requirements. This is your way of getting assured results in production work.



Markings on Cu-connections

Elpress marking system for Cu-connectors shows logotype, conductor area and ID-number for crimp die to be used. This system enables final inspection of proper die use as the die number is automatically imprinted by the die on the crimped barrel, see picture above.

Checking measures KRF/KSF, L dies (N-measure)

Type KRF/KSF with B (L) dies

KRF/KSF (L) mm ²	Die no.	max N mm
25	13B11L	8.8
35	13B13L	10.3
50	13B14,5L/13CB14,5L	10.9
70	13B17L/13CB17L	13.5
95	13B20L/13CB20L	16.4
120	13B22L/13CB22L	16.5
150	13B25L/13CB25L/B2525L	20.3
185	13B27L/13CB27L/B2527L	20.6
240	13B30L/13CB30L/B2530L	23.4
300	B2532L	24.6
400	B2538L	30.5
500	B2542L	30.7
630	B2550L	38.5

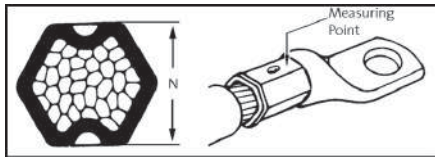

Stud holes in terminal palms

Screw dimension	Hole diameter tolerance H13 (Ø mm)
M3	3.2
M4	4.3
M5	5.3
M6	6.4
M8	8.4
M10	10.5
M12	13
M16	17
M20	21
M24	25



Marking of tube terminals (L)

20 (on the terminal neck) ID-no. for the hexagonal die

(Elpress logo) 95-12F (on the palm)
 95 = Cu-conductor area, mm²
 12 = hole for screw M12
 F = KRF



Marking of connectors

(Elpress logo) 20 ID-no. for hexagonal die

95 F
 95 = Cu-conductor area, mm²
 F = KSF

IEC classes

Definitions for cable classes:

- Solid = IEC 60228 Class 1
- Stranded = IEC 60228 Class 2
- Flexible = IEC 60228 Class 5
- Very flexible = IEC 60228 Class 6

Electrical Machines cross reference table for MCM and AWG for mm²

MCM	Area mm ²	AWG	Area mm ²
250	127	36	0.013
300	152	34	0.020
350	177	32	0.032
400	203	30	0.051
450	228	28	0.080
500	253	26	0.13
550	279	24	0.20
600	304	22	0.33
650	329	20	0.56
700	355	19	0.65
750	380	18	0.82
800	405	17	1.04
850	431	16	1.31
900	456	15	1.65
1000	507	14	2.08
1100	557	13	2.62
1200	608	12	3.31
1300	659	11	4.17
1400	709	10	5.26
1500	760	9	6.63
1600	811	8	8.37
1700	861	7	10.6
1800	912	6	13.3
1900	963	5	16.8
2000	1013	4	21.2
		3	26.4
		2	33.6
		1	42.4
		1/0	53.5
		2/0	67.4
		3/0	85.5
		4/0	107

Notes:

1. The information in this table is derived from catalogues distributed by cable suppliers and does not relate to official standards.
2. The cross sections that relate to AWG vary depending on different design of the conductors, ie numbers of strands.
 AWG > 20 relates to solid conductors.
 AWG ≤ 20 relates to multi-strand conductors.
 The exact cross sections for specific numbers of strands can be found in cable-supplier catalogues.

Tube terminals 16 - 630 mm²

- Material: Cu 99.95%, tin plated Cu/Sn.
- Cable inspection hole. For winding, flexible and stranded Cu-conductors.



Marking example KRF: 95 12F, (Elpress logotype included) 20
 95 = mm² 12 = palm hole for M12 F = type KRF, 20 = Die No.

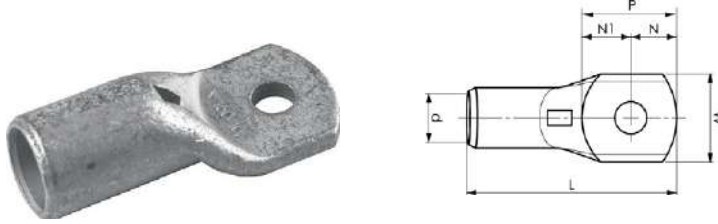

Conductor Cu mm ²	Winding mm ²	Name	Screw	W mm	d	t	N	N1	P	L	s	Tool	Die	Pcs/pack	Note
16		KRF16-12L	12	22	6	1,6	12	23	25	47	11	V1300	9L	100	Round conductors only
16		KRF16-10L	10	16	6	2,2	10	11	21	38	11	V1300	9L	100	Round conductors only
16		KRF16-8L	8	13	6	2,9	8	9	17	34	11	V1300	9L	100	Round conductors only
16		KRF16-6L	6	13	6	2,9	8	9	17	34	11	V1300	9L	100	Round conductors only
25	30-47	KRF25-8L	8	16	8	2,9	8	10	18	39	13	V1300	11L	100	
25	30-47	KRF25-10L	10	17	8	2,9	10	11	21	42	13	V1300	11L	100	
25	30-47	KRF25-12L	12	22	8	2,1	12	13	25	47	13	V1300	11L	100	
25	30-47	KRF25-6L	6	16	8	2,9	8	10	18	39	13	V1300	11L	100	
35	45-70	KRF35-8L	8	18	9	3,9	10	11	21	47	16	V1300	13L	100	
35	45-70	KRF35-10L	10	18	9	3,9	10	11	21	47	16	V1300	13L	100	
35	45-70	KRF35-12L	12	22	9	3,2	12	14	26	52	16	V1300	13L	100	
35	45-70	KRF35-6L	6	18	9	3,9	10	11	21	47	16	V1300	13L	100	
50	69-103	KRF50-8L	8	21	11	3,4	11	11	22	50	19	V1300	14,5L	100	
50	69-103	KRF50-10L	10	21	11	3,4	11	11	22	50	19	V1300	14,5L	100	
50	69-103	KRF50-12L	12	21	11	3,4	12	13	25	53	19	V1300	14,5L	100	
50	69-103	KRF50-16L	16	27	11	2,7	15	16	31	59	19	V1300	14,5L	100	
70	100-120	KRF70-8L	8	25	13	3,9	11	11	22	55	22	V1300	17L	50	
70	100-120	KRF70-10L	10	25	13	3,9	11	11	22	55	22	V1300	17L	50	
70	100-120	KRF70-12L	12	25	13	3,9	12	13	25	58	22	V1300	17L	50	
70	100-120	KRF70-16L	16	28	13	3,5	15	16	31	64	22	V1300	17L	50	
95	113-161	KRF95-8L	8	29	15	4,9	15	16	31	69	25	V1300	20L	50	
95	113-161	KRF95-10L	10	29	15	4,9	15	16	31	69	25	V1300	20L	50	
95	113-161	KRF95-12L	12	29	15	4,9	15	16	31	69	25	V1300	20L	50	
95	113-161	KRF95-16L	16	29	15	4,9	15	16	31	69	25	V1300	20L	50	
120	145-185	KRF120-10L	10	32	17	4,9	15	16	31	73	27	V1300	22L	25	
120	145-185	KRF120-12L	12	32	17	4,9	15	16	31	73	27	V1300	22L	25	
120	145-185	KRF120-16L	16	32	17	4,9	15	16	31	73	27	V1300	22L	25	
120	145-185	KRF120-8L	8	32	17	4,9	15	16	31	73	27	V1300	22L	25	
150	180-220	KRF150-16L	16	36	19	5,9	15	16	31	80	32	V1300, V250	25L	25	
150	180-220	KRF150-8L	8	36	19	5,8	15	16	31	80	32	V1300, V250	25L	25	
150	180-220	KRF150-10L	10	36	19	5,9	15	16	31	80	32	V1300, V250	25L	25	
150	180-220	KRF150-12L	12	36	19	5,9	15	16	31	80	32	V1300, V250	25L	25	
150	180-220	KRF150-00L		36	19	5,8			31	80	32	V1300, V250	25L	25	Unholed palm
185	220-265	KRF185-16L	16	39	21	5,9	15	16	31	86	37	V1300, V250	27L	20	
185	220-265	KRF185-10L	10	39	21	5,9	15	16	31	86	37	V1300, V250	27L	20	
185	220-265	KRF185-12L	12	39	21	5,9	15	16	31	86	37	V1300, V250	27L	20	
185	220-265	KRF185-20L	20	39	21	5,9	19	19	38	93	37	V1300, V250	27L	20	
185	220-265	KRF185-00L		39	21	5,9			38	93	37	V1300, V250	27L	20	Unholed palm
240	302-343	KRF240-10L	10	44	24	5,9	19	19	38	95	37	V1300, V250	30L	10	
240	302-343	KRF240-12L	12	44	24	5,9	19	19	38	95	37	V1300, V250	30L	10	
240	302-343	KRF240-16L	16	44	24	5,9	19	19	38	95	37	V1300, V250	30L	10	
240	302-343	KRF240-8L	8	44	24	5,9	19	19	38	95	37	V1300, V250	30L	10	
240	302-343	KRF240-00L		44	24	5,8			38	95	37	V1300, V250	30L	10	Unholed palm
300	340-400	KRF300-00L		46	24,5	6,8			54	116	44	V250	32L	10	Unholed palm
300	340-400	KRF300-12L	12	46	24,5	6,8	22	32	54	116	44	V250	32L	10	
300	340-400	KRF300-16L	16	46	24,5	6,8	22	32	54	116	44	V250	32L	10	
300	340-400	KRF300-20L	20	46	24,5	6,8	22	32	54	116	44	V250	32L	10	
300	340-400	KRF300-10L	10	46	24,5	6,8	22	32	54	116	44	V250	32L	10	
400	412-500	KRF400-12L	12	56	30	7,8	22	33	55	125	52	V250	38L	10	
400	412-500	KRF400-16L	16	56	30	7,8	22	33	55	125	52	V250	38L	10	
400	412-500	KRF400-10L	10	56	30	7,8	22	33	55	125	52	V250	38L	10	
400	412-500	KRF400-00L		56	30	7,8			55	125	52	V250	38L	10	Unholed palm
400	412-500	KRF400-20L	20	56	30	7,8	23	25	48	119	52	V250	38L	10	
500	500-580	KRF500-16L	16	61	33	8,8	25	35	60	150	68	V250	42L	5	
500	500-580	KRF500-20L	20	61	33	8,8	25	35	60	150	68	V250	42L	5	
500	500-580	KRF500-12L	12	61	33	8,8	25	35	60	150	49	V250	42L	5	
500	500-580	KRF500-00L		61	33	8,8			70	160	70	V250	42L	5	Unholed palm
630	630-730	KRF630-20L	20	73	39	10,8	25	35	60	175	80	V250	50L	5	

t = palm thickness, s = strip length

Tube terminals 90°, 25 - 400 mm²

- Material: Cu 99.95%, tin plated Cu/Sn.
- Cable inspection hole. For winding, flexible and stranded Cu-conductors.



Marking example KRF: 95 12F (Elpress logotype included) 20
 95 = mm², 12 = palm hole for M12, F = type KRF, 20 = Die No.

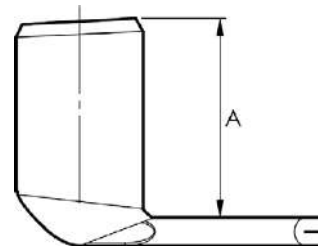
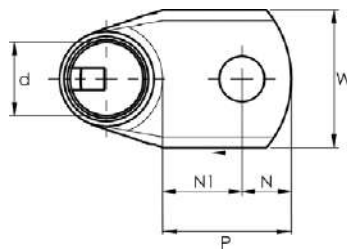

Conductor Cu mm ²	Winding mm ²	Name	Screw	W mm	d	N	N1	P	A	t	s	Tool	Die	Pcs/pack
25	30-47	KRF25-10L-90GR	10	17	8	11,5	13,5	25	18,5	2,9	13	V1300	11L	100
25	30-47	KRF25-8L-90GR	8	16	8	8,5	12	20,5	18,5	2,9	13	V1300	11L	50
35	45-70	KRF35-8L-90GR	8	18	9	8,5	12	20,5	22,5	3,9	16	V1300	13L	100
35	45-70	KRF35-10L-90GR	10	18	9	11,5	13,5	25	22,5	3,9	16	V1300	13L	100
35	45-70	KRF35-12L-90GR	12	19	9	12,5	17,5	30	22,5	3,7	16	V1300	13L	100
50	69-103	KRF50-10L-90GR	10	21	11	11,5	18,5	30	30,5	3,4	19	V1300	14,5L	100
50	69-103	KRF50-12L-90GR	12	21	11	12,5	19,5	32	30,5	3,4	19	V1300	14,5L	100
50	69-103	KRF50-8L-90GR	8	21	11	8,5	17,5	28	30,5	3,4	19	V1300	14,5L	100
70	100-120	KRF70-12L-90GR	12	24	13	12,5	19,5	32	31,5	3,9	22	V1300	17L	50
70	100-120	KRF70-8L-90GR	8	24	13	8,5	17,5	26	31,5	3,9	22	V1300	17L	50
70	100-120	KRF70-10L-90GR	10	24	13	11,5	18,5	30	31,5	3,9	22	V1300	17L	50
95	113-161	KRF95-8L-90GR	8	28	15	8,5	17,5	26	32,5	4,9	25	V1300	20L	50
95	113-161	KRF95-12L-90GR	12	28	15	12,5	19,5	32	32,5	4,9	25	V1300	20L	50
95	113-161	KRF95-10L-90GR	10	28	15	11,5	18,5	30	32,5	4,9	25	V1300	20L	50
95	113-161	KRF95-16L-90GR	16	29	15	15,5	20,5	36	32,5	4,9	25	V1300	20L	50
120	145-185	KRF120-12L-90GR	12	32	17	12,5	19,5	32	42	4,9	27	V1300	22L	25
120	145-185	KRF120-10L-90GR	10	32	17	11,5	18,5	30	42	4,9	27	V1300	22L	25
120	145-185	KRF120-16L-90GR	16	32	17	15,5	20,5	36	42	4,9	27	V1300	22L	25
150	180-220	KRF150-10L-90GR	10	36	19	11,5	18,5	30	47	5,9	27	V1300, V250	25L	25
150	180-220	KRF150-12L-90GR	12	36	19	12,5	19,5	32	47	5,9	27	V1300, V250	25L	25
150	180-220	KRF150-16L-90GR	16	36	19	15,5	20,5	36	47	5,9	32	V1300, V250	25L	25
185	220-265	KRF185-10L-90GR	10	39	21	11,5	18,5	30	42,5	5,8	37	V1300, V250	27L	25
185	220-265	KRF185-12L-90GR	12	39	21	12,5	19,5	32	42,5	5,8	37	V1300, V250	27L	20
240	302-343	KRF240-12L-90GR	12	44	24	12,5	19,5	32	47	5,9	37	V1300, V250	30L	15
240	302-343	KRF240-10L-90GR	10	44	24	11,5	18,5	30	47	5,9	37	V1300, V250	30L	15
300	340-400	KRF300-12L-90GR	12	46	24,5	15	25	40	57	6,9	44	V250	32L	10
300	340-400	KRF300-16L-90GR	16	46	24,5	20	25	45	57	6,9	44	V250	32L	10
400	412-500	KRF400-16L-90GR	16	56	30	22	33	55	64,2	7,8	52	V250	38L	5
400	412-500	KRF400-12L-90GR	12	56	30	22	33	55	64,2	7,8	52	V250	38L	5

t = palm thickness, s = strip length

Tube terminals 45°, 25 - 400 mm²

- Material: Cu 99.95%, tin plated Cu/Sn.
- Cable inspection hole. For winding, flexible and stranded Cu-conductors.



Marking example KRF: 95 12F (Elpress logotype included) 20
 95 = mm² 12 = palm hole for M12 F = type KRF, 20 = Die No.

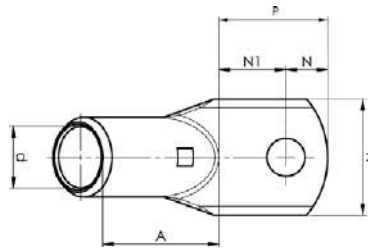

Conductor Cu mm ²	Winding mm ²	Name	Screw	W mm	d	N	N1	P	A	t	s	Tool	Die	Pcs/pack
25	30-47	KRF25-10L-45GR	10	17	8	11,5	13,7	25,2	23	2,9	13	V1300	11L	100
25	30-47	KRF25-8L-45GR	8	16	8	8,5	12,2	20,7	23	2,9	13	V1300	11L	50
35	45-70	KRF35-8L-45GR	8	18	9	8,5	12	20,5	30	3,9	16	V1300	13L	100
35	45-70	KRF35-10L-45GR	10	18	9	11,5	13,5	25	30	3,9	16	V1300	13L	100
35	45-70	KRF35-12L-45GR	12	19	9	12,5	17,5	30	30	3,7	16	V1300	13L	100
50	69-103	KRF50-8L-45GR	8	21	11	8,5	17,5	26	31	3,4	19	V1300	14,5L	100
50	69-103	KRF50-10L-45GR	10	21	11	11,5	18,5	30	31	3,4	19	V1300	14,5L	100
50	69-103	KRF50-12L-45GR	12	21	11	12,5	19,5	32	31	3,4	19	V1300	14,5L	100
70	100-120	KRF70-10L-45GR	10	25	13	11,5	18,5	30	35	3,9	22	V1300	17L	50
70	100-120	KRF70-12L-45GR	12	24	13	12,5	19,5	32	35	3,9	22	V1300	17L	50
95	113-161	KRF95-10L-45GR	10	28	15	11,5	18,5	30	40	4,9	25	V1300	20L	50
95	113-161	KRF95-12L-45GR	12	29	15	12,5	19,5	32	40	4,9	25	V1300	20L	50
120	145-185	KRF120-10L-45GR	10	32	17	11,5	18,5	30	43	4,9	27	V1300	22L	25
120	145-185	KRF120-12L-45GR	12	32	17	12,5	19,5	32	43	4,9	27	V1300	22L	25
150	180-220	KRF150-12L-45GR	12	36	19	12,5	19,5	32	49	5,9	32	V1300, V250	25L	25
150	180-220	KRF150-10L-45GR	10	36	19	11,5	18,5	30	49	5,9	32	V1300, V250	25L	25
185	220-265	KRF185-12L-45GR	12	39	21	12,5	19,5	32	55	5,8	37	V1300, V250	27L	20
185	220-265	KRF185-10L-45GR	10	39	21	11,5	18,5	30	55	5,8	37	V1300, V250	27L	20
240	302-343	KRF240-12L-45GR	12	44	24	12,5	19,5	32	57	5,8	37	V1300, V250	30L	10
240	302-343	KRF240-10L-45GR	10	44	24	11,5	18,5	30	57	5,8	37	V1300, V250	30L	10
300	340-400	KRF300-12L-45GR	12	46	24,5	22	18	40	61	6,8	44	V250	32L	10
300	340-400	KRF300-16L-45GR	16	46	24,5	22	18	40	61	6,8	44	V250	32L	10
400	412-500	KRF400-12L-45GR	12	56	30	22	18	40	75	7,8	52	V250	38L	8

t = palm thickness, s = strip length

Tube terminals with two stud holes 50 - 630 mm²

- Material: Cu 99.95%, tin plated Cu/Sn.
- Cable inspection hole. For winding, flexible and stranded Cu-conductors.



Marking example KRF: 95 12F (Elpress logotype included) 20
 95 = mm² 12 = palm hole for M12 F = type KRF, 20 = Die No.



mm ²	Winding mm ²	Name	Screw	W mm	d	N	N1	P	cc	L	t	s	Tool	Die	Pcs/ pack
50	69-103	KRF50-12X2-44,5L	12x2	21	11	12	18,5	75	44,5	105	3,4	19	V1300	14,5L	50
70	100-120	KRF70-12X2-44,5L	12x2	25	13	12	17,5	74	44,5	107	3,9	22	V1300	17L	25
95	113-161	KRF95-12X2-40L	12x2	29	15	12	18	70	40	109	4,9	25	V1300	20L	25
95	113-161	KRF95-12X2-44,5L	12x2	29	15	12	18,5	75	44,5	113	4,9	25	V1300	20L	25
120	145-185	KRF120-12X2-40L	12x2	32	17	12	19	71	40	113	4,9	27	V1300	22L	25
120	145-185	KRF120-12X2-44,5L	12x2	32	17	12	17,5	74	44,5	116	4,9	27	V1300	22L	25
150	180-220	KRF150-12X2-40L	12x2	36	19	12	19	71	40	120	5,9	32	V1300, V250	25L	20
150	180-220	KRF150-12X2-44,5L	12x2	36	19	12	18,5	75	44,5	123	5,9	32	V1300, V250	25L	20
185	220-265	KRF185-12X2-40L	12x2	39	21	12	20	72	40	126	5,9	37	V1300, V250	27L	20
296	220-265	KRF185-12X2-44,5L	22x2	39	21	12	19,5	76	44,5	130	5,9	37	V1300, V250	27L	10
240	302-343	KRF240-12X2-40L	12x2	44	24	12	21	73	40	129	5,9	37	V1300, V250	30L	10
240	302-343	KRF240-12X2-44,5L	12x2	44	24	12	19,5	76	44,5	132	5,9	37	V1300, V250	30L	10
300	340-400	KRF300-12X2-40L	12x2	45	24,5	12	22	74	40	136	6,8	44	V250	32L	10
300	340-400	KRF300-12X2-44,5L	12x2	46	24,5	12	20,5	77	44,5	139	6,8	44	V250	32L	10
400	412-500	KRF400-12X2-40L	12x2	56	30	12	23	75	40	145	7,8	52	V250	38L	5
400	412-500	KRF400-12X2-44,5L	12x2	56	30	12	20,5	77	44,5	147	7,8	52	V250	38L	5
500	500-580	KRF500-12X2-40L	12x2	61	33	15	15	70	40	160	8,8	70	V250	42L	5
500	500-580	KRF500-12X2-44,5L	12x2	61	33	12	18,5	75	44,5	165	8,8	70	V250	42L	5
630	630-730	KRF630-12X2-44,5L	12x2	73	39	15	20,5	80	44,5	195	10,8	80	V250	50L	

t = palm thickness, s = strip length

Tube terminals with two stud holes (one oval) 50 - 240 mm²

- Material: Cu 99.95%, tin plated Cu/Sn.
- Cable inspection hole. For winding, flexible and stranded Cu-conductors.
- With an oval hole nearest the tube.



Marking example KRF: 95 12F (Elpress logotype included) 20
 95 = mm² 12 = palm hole for M12 F = type KRF, 20 = Die No.



Conductor Cu mm ²	Winding mm ²	Name	Screw	W mm	d	N	N1	P	cc	L	t	s	Tool	Die	Pcs/ pack
50	69-103	KRF50-10X2-24-26L	10x2	21	11	11	22	58	25	87	3,4	19	V1300	14,5L	50
70	100-120	KRF70-10X2-24-26L	10x2	25	13	11	17	53	25	86	3,9	22	V1300	17L	50
95	113-161	KRF95-10X2-24-26L	10x2	29	15	11	19	55	25	93	4,9	25	V1300	20L	25
120	145-185	KRF120-10X2-24-26L	10x2	32	17	11	19	55	25	97	4,9	27	V1300	22L	25
150	180-220	KRF150-10X2-24-26L	10x2	36	19	11	19	55	25	104	5,9	32	V1300, V250	25L	25
185	220-265	KRF185-10X2-24-26L	10x2	39	21	11	21	57	25	111	5,9	37	V1300, V250	27L	20
240	302-343	KRF240-10X2-24-26L	10x2	44	24	11	22	58	25	114	5,9	37	V1300, V250	30L	10

t = palm thickness, s = strip length

Tube terminals 90° with two stud holes 150 - 630 mm²

- Material: Cu 99.95%, tin plated Cu/Sn.
- Cable inspection hole.
- For winding, flexible and stranded Cu-conductors.



Marking example KRF: 150 12F (Elpress logotype included) 25
 150 = mm² 12 = palm hole for M12 F = type KRF 25 = Die No.

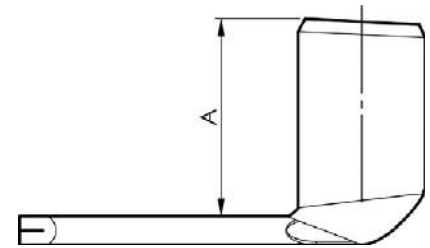
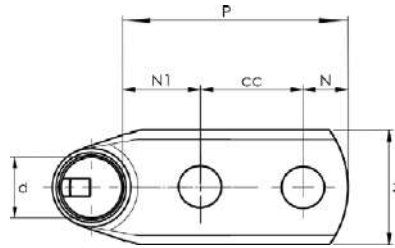

Conductor Cu mm ²	Winding mm ²	Name	Screw	W mm	d	N	N1	P	cc	A	t	s	Tool	Die	Pcs/pack
150	180-220	KRF150-12X2-40L-90GR	12x2	36	19	12	15	67	40	46,1	5,9	32	V1300, V250	25L	20
150	180-220	KRF150-12X2-44,5L-90GR	12x2	36	19	12	16,5	73	44,5	50	5,9	32	V1300, V250	25L	25
240	302-343	KRF240-12X2-40L-90GR	12x2	44	24	12	22	74	40	57,1	5,9	37	V1300, V250	30L	10
240	302-343	KRF240-12X2-44,5L-90GR	12x2	44	24	12	15,5	72	44,5	57,1	5,8	37	V1300, V250	30L	15
300	340-400	KRF300-12X2-40L-90GR	12x2	46	24,5	12	22	74	40	70	6,8	44	V250	32L	10
400	412-500	KRF400-12X2-44,5L-90GR	12x2	56	30	12	23,5	80	44,5	70	7,8	52	V250	38L	5
500	500-580	KRF500-12X2-44,5L-90GR	12x2	61	33	15	20,5	80	44,5	86	8,8	70	V250	42L	4
630	630-730	KRF630-12X2-44,5L-90GR	12x2	73	39	15	17,5	80	44,5	112	10,8	80	V250	50L	1

t = palm thickness, s = strip length

Tube terminals 90° with two stud holes (one oval) 70 - 240 mm²

- Material: Cu 99.95%, tin plated Cu/Sn.
- Cable inspection hole.
- For winding, flexible and stranded Cu-conductors.
- With an oval hole nearest the tube.



Marking example KRF: 150 12F (Elpress logotype included) 25
 150 = mm² 12 = palm hole for M12 F = type KRF 25 = Die No.

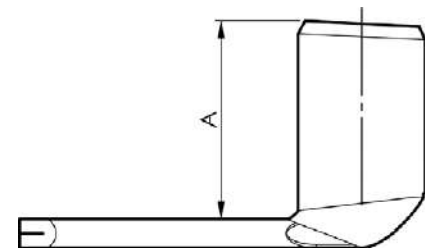
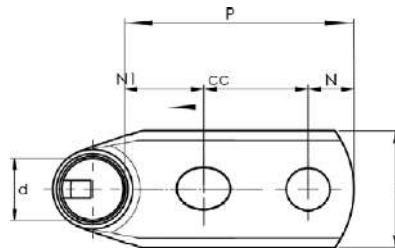

Conductor Cu mm ²	Winding mm ²	Name	Screw	W mm	d	N	N1	P	cc	A	t	s	Tool	Die	Pcs/pack
70	100-120	KRF70-10X2-24-26L-90GR	10x2	25	13	11	16	51	24	30,1	3,9	22	V1300	17L	50
150	180-220	KRF150-10X2-24-26L-90GR	10x2	36	19	11	18	53	24	48,1	5,9	32	V1300, V250	25L	20
240	302-343	KRF240-10X2-24-26L-90GR	10x2	44	24	11	19	56	24	57,1	5,9	37	V1300, V250	30L	10

t = palm thickness, s = strip length

Through connectors 16 - 630 mm²

- Material: Cu 99.95%, tin plated Cu/Sn.
- Cable inspection hole and cable stop.
- For winding, flexible and stranded Cu-conductors.



Marking example: 20 95F (earth-sign) Elpress logotype included
 20 = die no. 95 = mm² F = type KSF

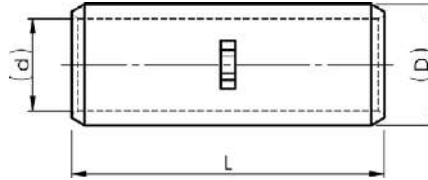

Conductor Cu mm ²	Winding mm ²	Name	d mm	D	L	s	Tool	Die	Pcs/pack	Note
16	-	KSF16L	6	9	35	11	V1300	9L	100	For use with round conductors only
25	30-47	KSF25L	8	11	35	13	V1300	11L	100	
35	45-70	KSF35L	9	13	35	17	V1300	13L	100	
50	69-103	KSF50L	11	14,5	45	22	V1300	14,5L	50	
70	100-120	KSF70L	13	17	45	22	V1300	17L	50	
95	113-161	KSF95L	15	20	45	25	V1300	20L	50	
120	145-185	KSF120L	17	22	55	27	V1300	22L	50	
150	180-220	KSF150L	19	25	65	32	V1300, V250	25L	25	
185	220-265	KSF185L	21	27	70	35	V1300, V250	27L	25	
240	302-343	KSF240L	24	30	70	35	V1300, V250	30L	25	
300	340-400	KSF300L	24,5	31,5	75	37	V250	32L	10	
400	412-500	KSF400L	30	38	100	50	V250	38L	10	
500	500-580	KSF500L	33	42	135	68	V250	42L	5	
630	630-730	KSF630L	39	50	170	80	V250	50L	2	

s = strip length

Reducer through connectors 35 - 630 mm²

- Material: Cu 99.95%, tin plated Cu/Sn.
- For winding, flexible and stranded Cu-conductors.



Marking example: 25-150F 20-95F Elpress logotype included
25 / 20 = Die No. 150, 95 = mm² F = type KSF

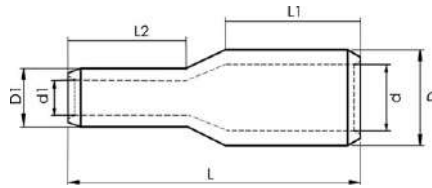

Conductor Cu mm ²	Winding mm ²	Name	d mm	d1	D	D1	L	L1	L2	s	s1	Tool	Die	Die (Smaller area)	Pcs/ pack
35-16	45-70/-	KSF35-16L	9	6	13	9	32	16,8	13	18		V1300	13L	9L	1
35-25	45-70/30-47	KSF35-25L	9	8	13	11	33	16	14	18	16	V600, V1300	13L	11L	100
50-25	69-103/30-47	KSF50-25L	11	8	14,5	11	40	20,4	16	22	18	V600, V1300	14,5L	11L	50
50-35	69-103/45-70	KSF50-35L	11	9	14,5	13	55	24,1	25	26	27	V600, V1300	14,5L	13L	50
70-25	100-120/30-47	KSF70-25L	13	8	17	11	46	24,5	16	26		V600, V1300	17L	11L	1
70-35	100-120/45-70	KSF70-35L	12,9	9	17	13	60	24,2	25	26	27	V600, V1300	17L	13L	50
70-50	100-120/69-103	KSF70-50L	13	11	17	14,5	50	24,2	20	26	22	V600, V1300	17L	14,5L	50
95-25	113-161/30-47	KSF95-25L	15	8	20	11	52	26,1	18	27	16	V600, V1300	20L	11L	25
95-35	113-161/45-70	KSF95-35L	15	9	20	13	60	25,4	25	27	27	V600, V1300	20L	13L	25
95-50	113-161/69-103	KSF95-50L	15	11	20	14,5	55	25,3	20	27	22	V600, V1300	20L	14,5L	25
95-70	113-161/100-120	KSF95-70L	15	13	20	17	60	25,2	25	27	27	V600, V1300	20L	17L	25
120-35	145-185/45-70	KSF120-35L	17	9	22	13	65	31,6	25	33	27	V600, V1300	22L	13L	25
120-50	145-185/69-103	KSF120-50L	17	11	22	14,5	60	31,5	20	33	22	V600, V1300	22L	14,5L	50
120-70	145-185/100-120	KSF120-70L	17	13	22	17	65	31,3	25	33	27	V600, V1300	22L	17L	25
120-95	145-185/113-161	KSF120-95L	17	15	22	20	70	31,2	31	33	33	V600, V1300	22L	20L	25
150-35	180-220/45-70	KSF150-35L	19	9	25	13	65	32	25	33	27	V1300	25L	13L	25
150-50	180-220/69-103	KSF150-50L	19	11	25	14,5	60	31,9	20	33	22	V1300	25L	14,5L	25
150-70	180-220/100-120	KSF150-70L	19	13	25	17	65	31,7	25	33	27	V1300	25L	17L	25
150-95	180-220/113-161	KSF150-95L	19	15	25	20	70	31,5	31	33	33	V1300	25L	20L	25
150-120	180-220/145-185	KSF150-120L	19	17	25	22	70	31,3	31	33	33	V1300	25L	22L	25
185-35	220-265/45-70	KSF185-35L	21	9	27	13	65	32,2	25	33	27	V1300	27L	13L	25
185-50	220-265/69-103	KSF185-50L	21	11	27	14,5	65	32,1	25	33	27	V1300	27L	14,5L	25
185-70	220-265/100-120	KSF185-70L	21	13	27	17	65	31,8	25	33	27	V1300	27L	17L	25
185-95	220-265/113-161	KSF185-95L	21	15	27	20	71	31,6	31	33	33	V1300	27L	20L	25
185-120	220-265/145-185	KSF185-120L	21	17	27	22	70	31,5	31	33	33	V1300	27L	22L	25
185-150	220-265/180-220	KSF185-150L	21	19	27	25	71	31,1	31	33	33	V1300, V250	27L	25L	25
240-35	302-343/45-70	KSF240-35L	24	9	30	13	65	32,3	25	33	27	V1300	30L	13L	25
240-50	302-343/69-103	KSF240-50L	24	11	30	14,5	70	32,2	30	33	32	V1300	30L	14,5L	25
240-70	302-343/100-120	KSF240-70L	24	13	30	17	65	33,5	25	33	27	V1300	30L	17L	25
240-95	302-343/113-161	KSF240-95L	24	15	30	20	71	31,8	31	33	33	V1300	30L	20L	25
240-120	302-343/145-185	KSF240-120L	24	17	30	22	70	31,8	31	33	33	V1300	30L	22L	25
240-150	302-343/180-220	KSF240-150L	24	19	30	25	70	31	31	33	33	V1300, V250	30L	25L	25
240-185	302-343/220-265	KSF240-185L	24	21	30	27	70	31,3	31	33	33	V1300, V250	30L	27L	25
300-70	340-400/100-120	KSF300-70L	24,5	13	31,5	17	70	36,1	24	37	26	V250, V1300	32L	17L	25
300-95	340-400/113-161	KSF300-95L	24,5	15	31,5	20	77	35,9	31	37	33	V250, V1300	32L	20L	25
300-120	340-400/145-185	KSF300-120L	24,5	17	31,5	22	76	35,9	31	37	33	V1300, V250	32L	22L	25
300-150	340-400/180-220	KSF300-150L	24,5	19	31,5	25	76	35,6	31	37	33	V250	32L	25L	10
300-185	340-400/220-265	KSF300-185L	24,5	21	31,5	27	76	35,4	31	37	33	V250	32L	27L	20
300-240	340-400/302-343	KSF300-240L	24,5	24	31,5	30	76	35,1	31	37	33	V250	32L	30L	20
400-35	412-500/45-70	KSF400-35L	30	9	38	13	82	47	25	47	27	V250, V1300	38L	13L	1
400-95	412-500/113-161	KSF400-95L	30	15	38	20	90	45	31	47	33	V1300, V250	38L	20L	10
400-120	412-500/145-185	KSF400-120L	30	17	38	22	90	45	31	47	33	V250, V1300	38L	22L	5
400-150	412-500/180-220	KSF400-150L	30	19	38	25	90	45	31	47	33	V250	38L	25L	10
400-185	412-500/220-265	KSF400-185L	30	21	38	27	90	45	31	47	33	V250	38L	27L	5
400-240	412-500/302-343	KSF400-240L	30	24	38	30	90	45	31	47	33	V1300, V250	38L	30L	10
300-400	412-500/340-400	KSF400-300L	30	24,5	38	31,5	90	45	35	47	37	V250	38L	32L	10
500-95	500-580/113-161	KSF500-95L	33	15	42	20	101	47	31	49	27	V250, V1300	42L	20L	10
500-120	500-580/145-185	KSF500-120L	33	17	42	22	101	47	31	49	33	V250, V1300	42L	22L	1
500-150	500-580/180-220	KSF500-150L	33	19	42	25	101	47	31	49	33	V250	42L	25L	10
185-500	500-580/220-265	KSF500-185L	33	21	42	27	101	47	31	49	33	V250	42L	27L	5
500-240	500-580/302-343	KSF500-240L	33	24	42	30	101	47	31	49	33	V250	42L	30L	5
500-300	500-580/340-400	KSF500-300L	33	24,5	42	31,5	105	47	35	49	37	V250	42L	32L	5
400-500	500-580/412-500	KSF500-400L	33	30	42	38	115	47	45	49	47	V250	42L	38L	5
630-240	630-730/302-343	KSF630-240L	39	24	50	30	111	60	35	62	37	V250	50L	30L	5
630-300	630-730/340-400	KSF630-300L	39	24,5	50	31,5	111	60	35	62	37	V250	50L	32L	5
630-400	630-730/412-500	KSF630-400L	39	30	50	38	121	60	45	62	47	V250	50L	38L	5
630-500	630-730/500-580	KSF630-500L	39	33	50	42	126	60	50	62	52	V250	50L	42L	4

s, s1 = insulation stripping length

Parallel through connectors, winding to flexible conductor 50 - 240 mm²

- Material: Cu 99,95%, tin plated Cu/Sn.
- For combination of winding and flexible or stranded conductors.



Marking example: 120 P22L Elpress logotype included
 120 = mm² P22L = die no.

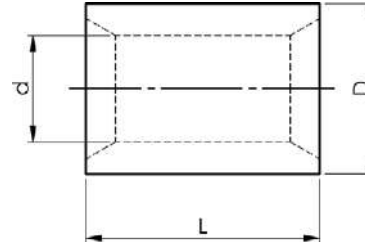
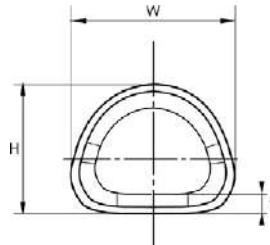

Conductor Cu mm ²	Winding mm ²	Name	W mm	d	D	H	L	t	Tool	Matrix and Punch	Pcs/pack
50	69-103	KS50PL	15,2	11	14,5	12,5	30	1,8	V1300	13P14,5ML/DL	100
70	100-120	KS70PL	17,7	13	17	15	30	2	V1300	13P17ML/DL	50
95	113-161	KS95PL	21,1	15	20	18	30	2,5	V1300	13P20ML/DL	100
120	145-185	KS120PL	22,7	17	22	20	32	2,5	V1300	13P22ML/DL	50
150	180-220	KS150PL	25,4	19	25	23	34	3	V1300	13P25ML/DL	50
185	220-265	KS185PL	27,4	21	27	25	36	3	V1300	13P27ML/DL	25
240	302-343	KS240PL	30,7	24	30	28	38	3	V1300	13P30ML/DL	25



Parallel through connectors



Parallel through connectors application

T-connectors with different area 25 - 500 mm² KTSF

- Material: Cu 99.95%, tin plated Cu/Sn.
- Cable inspection hole.
- For winding, flexible and stranded Cu-conductors.



Marking example: Elpress Logotype

20 = Elpress Die no. 20 2x95F = 2 entries 95 mm²

F = KSF (Flexible, Stranded or Winding Conductors)

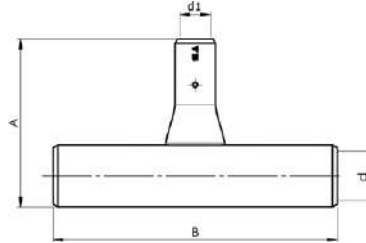

Conductor Cu mm ²	Winding mm ²	Name	d mm	d1	A	B	Die (Branch conductor)	Die (through conductor)	Tools	Pcs/ pack
25-50	30-47, 69-103	KTSF25-50	8	11	69,5	80	11L	14,5L	V600, V1300	20
50-150	69-103, 180-220	KTSF50-150	11	19	91	110	14,5L	25L	V1300, V250	5
70-95	100-120, 113-161	KTSF70-95	13	15	77	100	17L	20L	V600, V1300	10
70-120	100-120, 145-185	KTSF70-120	13	17	87	110	17L	22L	V600, V1300	5
70-150	100-120, 180-220	KTSF70-150	13	19	91	110	17L	25L	V1300, V250	5
70-240	100-120, 302-343	KTSF70-240	13	24	89	120	17L	30L	V1300, V250	5
95-35	113-161, 45-70	KTSF95-35	15	9	70	93	20L	13L	V600, V1300	10
95-50	113-161, 69-103	KTSF95-50	15	11	75	96	20L	14,5L	V600, V1300	10
95-150	113-161, 180-220	KTSF95-150	15	19	92	110	20L	25L	V1300, V250	5
95-240	113-161, 302-343	KTSF95-240	15	24	90	120	20L	30L	V1300, V250	5
120-150	145-185, 180-220	KTSF120-150	17	19	92	120	22L	25L	V1300, V250	5
120-185	145-185, 220-265	KTSF120-185	17	21	96	120	22L	27L	V1300, V250	5
150-50	180-220, 69-103	KTSF150-50	19	11	80	124	25L	14,5L	V1300, V250	10
150-95	180-220, 113-161	KTSF150-95	19	15	83	124	25L	20L	V1300, V250	8
185-35	220-265, 45-70	KTSF185-35	21	9	80	105	27L	13L	V1300, V250	6
185-50	220-265, 69-103	KTSF185-50	21	11	85	105	27L	14,5L	V1300, V250	6
185-95	220-265, 113-161	KTSF185-95	21	15	88	110	27L	20L	V1300, V250	6
185-150	220-265, 180-220	KTSF185-150	21	19	97	124	27L	25L	V1300, V250	6
240-35	302-343, 45-70	KTSF240-35	24	9	80	105	30L	13L	V1300, V250	5
240-50	302-343, 69-103	KTSF240-50	24	11	85	129	30L	14,5L	V1300, V250	6
240-95	302-343, 113-161	KTSF240-95	24	15	88	129	30L	20L	V1300, V250	6
240-120	302-343, 145-185	KTSF240-120	24	17	89	129	30L	22L	V1300, V250	5
240-150	302-343, 180-220	KTSF240-150	24	19	97	129	30L	25L	V1300, V250	5
240-185	302-343, 220-265	KTSF240-185	24	21	99	129	30L	27L	V1300, V250	4
240-400	302-343, 412-500	KTSF240-400	24	30	129	154	30L	38L	V1300, V250	2
300-150	340-400, 180-220	KTSF300-150	24,5	19	98	130	32L	25L	V1300, V250	4
400-35	412-500, 45-70	KTSF400-35	30	9	92	160	38L	13L	V250	4
400-50	412-500, 69-103	KTSF400-50	30	11	97	160	38L	14,5L	V250	4
400-95	412-500, 113-161	KTSF400-95	30	15	99	170	38L	20L	V250	4
400-150	412-500, 180-220	KTSF400-150	30	19	103	175	38L	25L	V250	2
400-185	412-500, 220-265	KTSF400-185	30	21	111	180	38L	27L	V250	2
400-240	412-500, 302-343	KTSF400-240	30	24	112	190	38L	30L	V250	2
400-300	412-500, 340-400	KTSF400-300	30	24,5	108	190	38L	32L	V250	2
500-35	500-580, 45-70	KTSF500-35	33	9	92	160	42L	13L	V250	2
500-50	500-580, 69-103	KTSF500-50	33	11	97	160	42L	14,5L	V250	2
500-95	500-580, 113-161	KTSF500-95	33	15	100	170	42L	20L	V250	2
500-150	500-580, 180-220	KTSF500-150	33	19	107	180	42L	25L	V250	2
500-185	500-580, 220-265	KTSF500-185	33	21	111	180	42L	27L	V250	2
500-240	500-580, 302-343	KTSF500-240	33	24	112	200	42L	30L	V250	2
500-300	500-580, 340-400	KTSF500-300	33	24,5	113	200	42L	32L	V250	2
500-400	500-580, 412-500	KTSF500-400	33	30	135	200	42L	38L	V250	2

T-connectors 110°, 35 - 400 mm² KTSF

- Material: Cu 99.95%, tin plated Cu/Sn.
- Cable inspection hole.
- For winding, flexible and stranded Cu-conductors.



Marking example: 14,5 3x50F Elpress logotype included
 14,5 = die no. 3x = no. of conductor entries 50 = mm² F = type KSF

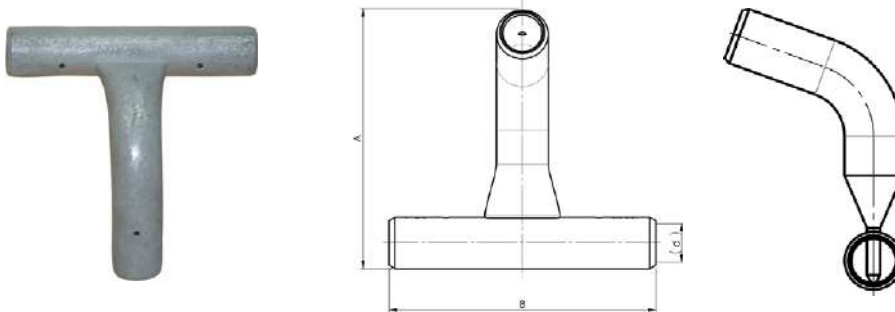

Conductor Cu mm ²	Winding mm ²	Name	d mm	A	B	Die	Tools	Pcs/ pack
35	45-70	KTSF35-110GR	9	63	87	13L	V600, V1300	20
50	69-103	KTSF50-110GR	11	66	96	14,5L	V600, V1300	20
70	100-120	KTSF70-110GR	13	80	100	17L	V600, V1300	10
95	113-161	KTSF95-110GR	15	84,5	103	20L	V600, V1300	6
120	145-185	KTSF120-110GR	17	91	120	22L	V600, V1300	6
150	180-220	KTSF150-110GR	19	104	124	25L	V1300, V250	4
185	220-265	KTSF185-110GR	21	112	124	27L	V1300, V250	2
240	302-343	KTSF240-110GR	24	116	129	30L	V1300, V250	2
300	340-400	KTSF300-110GR	24,5	119	130	32L	V1300, V250	2
400	412-500	KTSF400-110GR	30	177	190	38L	V250	3

T-connectors 35 - 630 mm² KTSF

- Material: Cu 99.95%, tin plated Cu/Sn.
- Cable inspection hole. For Cu-conductors; flexible, stranded and winding.



Marking example: 14,5 3x50F Elpress logotype included
 14,5 = die no. 3x = no. of conductor entries 50 = mm²
 F = type KSF, flexible, stranded and winding conductors

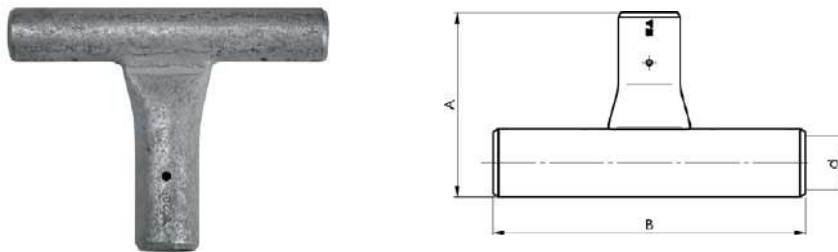

Conductor Cu mm ²	Winding mm ²	Name	d mm	A	B	Die	Tools	Pcs/ pack
35	45-70	KTSF35	9	63	87	13L	V600, V1300	20
50	69-103	KTSF50	11	70	96	14,5L	V600, V1300	20
70	100-120	KTSF70	13	74	100	17L	V600, V1300	10
95	113-161	KTSF95	15	77	103	20L	V600, V1300	10
120	145-185	KTSF120	17	87,5	120	22L	V600, V1300	6
150	180-220	KTSF150	19	92	124	25L	V1300, V250	6
185	220-265	KTSF185	21	96	124	27L	V1300, V250	6
240	302-343	KTSF240	24	100	129	30L	V1300, V250	4
300	340-400	KTSF300	24,5	101,5	130	32L	V1300, V250	4
400	412-500	KTSF400	30	130	190	38L	V250	2
500	500-580	KTSF500	33	134,5	200	42L	V250	2
630	630-730	KTSF630	39	168	235	50L	V250	2

Tube terminals 0,75 - 10 mm² KR

- Material: Cu 99.95%, tin plated Cu/Sn.
- For stranded (class 2) up to multi stranded (class 6) Cu-conductors, according to IEC 60228.
- UL approved (1.5 -10 mm²).

Marking example KR: 10 10
10 = mm² 10 = Plate hole for M10

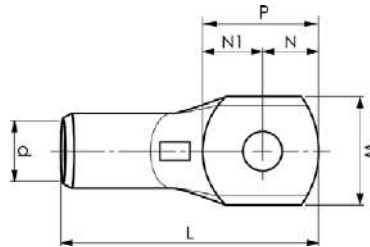

mm ²	Name	Screw	W mm	d	t	N	N1	L	s	P	Tool	Inspection hole	Die	Pcs/pack
0,75	KR0,75-3	3	6	1,3	0,85	3,2	3,8	16	7,5	7	DKB0325, DKB0760			100
0,75	KR0,75-4	4	6	1,3	0,8	3,2	3,5	17	7,5	6,7	DKB0325, DKB0760			100
1,5	KR1,5-3	3	6,5	1,8	1	3,4	3,6	16	7,5	7	DKB0325, DKB0760			100
1,5	KR1,5-4	4	6,5	1,8	0,9	4,2	3,8	17	7,5	8	DKB0325, DKB0760			100
1,5	KR1,5-5	5	7,5	1,8	0,85	4,8	4,7	18	7,5	9,5	DKB0325, DKB0760			100
2,5	KR2,5-3	3	7,5	2,3	1,3	3,5	4,1	17	7	7,6	DKB0325, DKB0760			100
2,5	KR2,5-4	4	7,5	2,3	1,3	4,2	4,1	18	7	8,3	DKB0325, DKB0760			100
2,5	KR2,5-5	5	8,5	2,3	1,1	4,8	4,8	19	7	9,6	DKB0325, DKB0760			100
2,5	KR2,5-6	6	8,5	2,4	1,1	5,1	5,8	19	7	10,9	DKB0325, DKB0760			100
4	KR4-4	4	8,5	3	1,5	4,2	5,8	22	8,5	10	GWB4099, ES2258			100
4	KR4-5	5	9	3	1,5	4,8	5,2	22	8,5	10	GWB4099, ES2258			100
4	KR4-6	6	9,9	3	1,3	5	7	23	8,5	12	GWB4099, ES2258			100
6	KR6-4	4	9,5	4	1,7	4	6	22	8,5	10	GWB4099, ES2258			100
6	KR6-5	5	9,5	4	1,7	5	6	22	8,5	11	GWB4099, ES2258			100
6	KR6-6	6	9,9	4	1,6	5,5	6,5	23	8,5	12	GWB4099, ES2258			100
6	KR6-8	8	13	4	1,2	7	10	30	8,5	17	GWB4099, ES2258			100
10	KR10-5	5	11,5	5	2,9	6	7,5	29	11	13,5	GWB4099, PVL350, V600, V1300, V250		8	100
10	KR10-6	6	11,5	5	3	6	7,5	29	11	13,5	GWB4099, PVL350, V600, V1300, V250	Yes	8	100
10	KR10-8	8	13,5	5	2,3	7,5	8,5	33	11	16	GWB4099, PVL350, V600, V1300, V250	Yes	8	100
10	KR10-10	10	16	5	2	8	10	34	11	18	GWB4099, PVL350, V600, V1300, V250	Yes	8	100
10	KR10-12	12	18,5	5	1,7	10	13,5	41	11	23,5	GWB4099, PVL350, V600, V1300, V250	Yes	8	100

t = plate thickness, s = strip length

Through connectors 0,75 - 10 mm² KS

- Material: Cu 99.95%, tin plated Cu/Sn.
- Cable inspection hole and cable stop.
- For stranded (class 2) up to multi stranded (class 6) Cu-conductors, according to IEC 60228.
- UL approved (1.5 -10 mm²).

Marking example: 8 10 Elpress logotype included
8 = die no. 10 = mm²

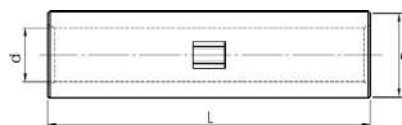

mm ²	Name	d mm	D	L	s	Tool	Die	Pcs/pack
0,75	KS0,75	1,3	2,8	14	7	DKB0325, DKB0760		100
1,5	KS1,5	1,8	3,3	14	7	DKB0325, DKB0760		100
2,5	KS2,5	2,3	4,2	16	8	DKB0325, DKB0760		100
4	KS4	3	5	19	9	GWB4099, ES2258		100
6	KS6	4	6	19	9	GWB4099, ES2258		100
10	KS10	5	8	30	15	PVL350, V600, V1300, V250	8	100

s = strip length

KRFS tube terminals 50 - 400 mm² with extra narrow palm

- Material: Cu 99,95%, tin plated Cu/Sn.
- Inspection hole.
- For stranded (class 2) up to multi stranded (class 6) Cu-conductors, according to IEC 60228.
- Easy to mount with grommets, enables pre-assembly.
- Palm width is smaller or as wide as the tube.



Marking example KRFS: 17 (neck) Elpress logotype 70 10F (palm)

17 = Die no 70 = mm², 10 = palm hole size M10,

F = type KRF for stranded and fine stranded conductors.

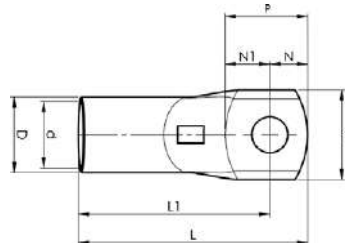

mm ²	Name	Screw	W mm	d	D	N	N1	P	L	L1	t	s	Tool	Die	Pcs/ pack
50	KRFS50-6	M6	15	11	14,5	11	11,5	22,5	51	40	4	19	PVL350, V600, V1300, V250	14,5	100
50	KRFS50-8	M8	16,5	11	14,5	11	11,5	22,5	51	40	3,8	19	PVL350, V600, V1300, V250	14,5	100
50	KRFS50-10	M10	16,5	11	14,5	11	12,5	23,5	52	41	3,8	19	PVL350, V600, V1300, V250	14,5	100
70	KRFS70-6	M6	17	13	17	11	12,5	23,5	58	47	4,5	22	PVL350, V600, V1300, V250	17	50
70	KRFS70-8	M8	17	13	17	11	12,5	23,5	58	47	4,5	22	PVL350, V600, V1300, V250	17	50
70	KRFS70-10	M10	19	13	17	11	12,5	23,5	58	47	3,9	22	PVL350, V600, V1300, V250	17	50
95	KRFS95-6	M6	19	15	20	11	14	25	63	52	5,7	25	V600, V1300, V250	20	50
95	KRFS95-8	M8	19	15	20	11	14	25	63	52	5,7	25	V600, V1300, V250	20	50
95	KRFS95-10	M10	19	15	20	11	14	25	63	52	5,7	25	V600, V1300, V250	20	50
95	KRFS95-12	M12	20	15	20	12	15	27	64	52	5,4	25	V600, V1300, V250	20	50
120	KRFS120-6	M6	19	17	22	11	13,5	24,5	67	56	5,9	27	V600, V1300, V250	22	25
120	KRFS120-8	M8	19	17	22	11	13,5	24,5	67	56	5,9	27	V600, V1300, V250	22	25
120	KRFS120-10	M10	19	17	22	11	13,5	24,5	67	56	5,9	27	V600, V1300, V250	22	25
120	KRFS120-12	M12	22	17	22	12	15	27	70	58	5	27	V600, V1300, V250	22	25
150	KRFS150-6	M6	25	19	25	11	14	25	74	63	6,3	32	V600, V1300, V250	25	25
150	KRFS150-8	M8	25	19	25	11	14	25	74	63	6,3	32	V600, V1300, V250	25	25
150	KRFS150-10	M10	25	19	25	11	14	25	74	63	6,3	32	V600, V1300, V250	25	25
150	KRFS150-12	M12	25	19	25	12	15	27	76	64	6,3	32	V600, V1300, V250	25	25
185	KRFS185-10	M10	27	21	27	11	13	24	79	68	6,6	37	V1300, V250	27	20
185	KRFS185-12	M12	27	21	27	12	15	27	82	70	6,6	37	V1300, V250	27	20
240	KRFS240A-10	M10	29	22,5	29	15	19	34	91	76	7,7	37	V1300, V250	30	10
240	KRFS240A-12	M12	29	22,5	29	15	19	34	91	76	7,7	37	V1300, V250	30	10
240	KRFS240A-16	M16	29	22,5	29	20	19	39	96	76	7,7	37	V1300, V250	30	10
300	KRFS300A-10	M10	31	24,5	31,5	15	19	34	94	79	8,6	40	V1300, V250	32	10
300	KRFS300A-12	M12	31	24,5	31,5	15	19	34	94	79	8,6	40	V1300, V250	32	10
300	KRFS300A-16	M16	31	24,5	31,5	20	19	39	99	79	8,6	40	V1300, V250	32	10
400	KRFS400A-12	M12	38	30	38	15	24	39	114	99	8,8	52	V1300, V250	38	10
400	KRFS400A-16	M16	38	30	38	20	39	39	114	94	8,8	52	V1300, V250	38	10

t = palm thickness, s = strip length

Parallel through connectors 20 - 630 mm² KS-P

- Material: Cu 99.95%, tin plated Cu/Sn.
- Cable inspection hole.
- For stranded (class 2) up to multi stranded (class 6) Cu-conductors, according to IEC 60228.



Marking example: 17 70 Elpress logotype included
17 = die no. 70 = mm²

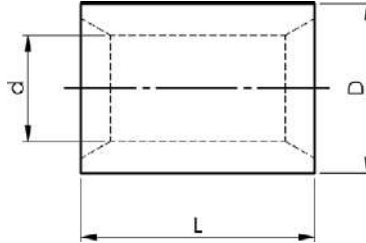

Conductor Cu mm ²	Name	d mm	D	L	Tool	Die	Pcs/pack
20-31	KS25P	8	11	14	PVL350, V600, V1300, V250	11	200
31-41	KS35P	9	13	16	PVL350, V600, V1300, V250	13	100
45-56	KS50P	11	14,5	18	PVL350, V600, V1300, V250	14,5	100
60-85	KS70P	13	17	18	PVL350, V600, V1300, V250	17	100
86-111	KS95P	15	20	20	V600, V1300, V250	20	100
111-130	KS120P	17	22	26	V600, V1300, V250	22	100
136-166	KS150P	19	25	26	V600, V1300, V250	25	50
170-210	KS185P	21	27	28	V1300, V250	27	50
220-255	KS240P	24	30	30	V1300, V250	30	25
300	KS300P	26	32	35	V1300, V250	32	50
400	KS400P	30	38	50	V1300, V250	38	50
500	KS500P	33	42	52	V250, V1470	42	10
630	KS630P	39	50	62	V250, V1470	50	10

CUT through connectors for solid conductors 6 - 16 mm²

- Material: Cu 99,95%, tin plated, Cu/Sn.
- For solid conductors.

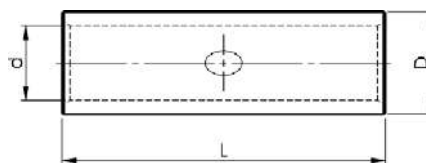

mm ²	Name	d mm	D	L	s	Tool	Pcs/pack
6	CUT6	3	5	27	12	ES2258, T2258	100
10	CUT10	4	6	27	12	ES2258, T2258	100
16	CUT16	5	8	35	15,5	ES2258, T2258	100

s = strip length

DIN 46235 tube terminals 6 - 1000 mm²

- Din tube terminals for Cu conductors.
- Material: Cu 99.95%, tin plated Cu/Sn.
- Dimensions according to DIN 46235, the number of crimps is indicated on the neck of the terminal.



Marking example: 95 10
95 = mm² 10 = palm hole for M10

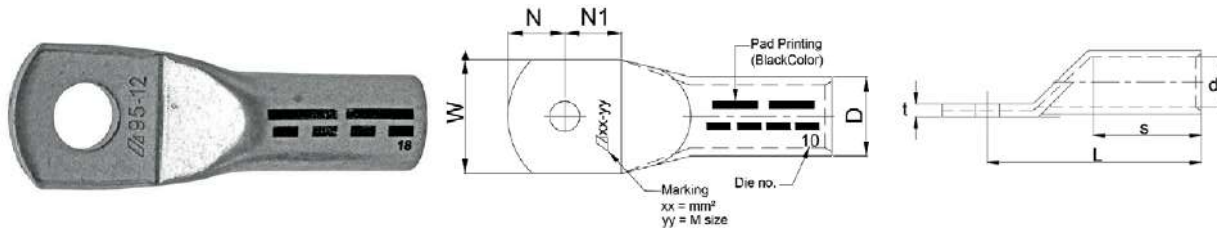

mm ²	Name	Screw	W mm	d	D	N	N1	L	t	s	Tool	Die	Pcs/pack
6	KRDIN6-5	5	8,5	3,8	5,5	7,5	7,5	31,5	1,5	10	V600, V1300	5	100
6	KRDIN6-6	6	8,5	3,8	5,5	9	9,5	33	1,5	10	V600, V1300	5	100
6	KRDIN6-8	8	13	3,8	5,5	10	10	35	1	10	V600, V1300	5	100
10	KRDIN10-5	5	9	4,5	6	7,5	7,5	34,5	1,5	10	V600, V1300	6	100
10	KRDIN10-6	6	9	4,5	6	9	9,5	36	1,5	10	V600, V1300	6	100
10	KRDIN10-8	8	13	4,5	6	10	10	37	1	10	V600, V1300	6	100
10	KRDIN10-10	10	15	4,5	6	10	11,5	39	0,8	10	V600, V1300	6	100
16	KRDIN16-6	6	13	5,5	8,5	9	9,5	45	2,5	20	V600, V1300	8	100
16	KRDIN16-8	8	13	5,5	8,5	11,5	11,5	47,5	2,5	20	V600, V1300	8	100
16	KRDIN16-10	10	17	5,5	8,5	13,5	13,5	49,5	1,9	20	V600, V1300	8	100
16	KRDIN16-12	12	18	5,5	8,5	13,5	13,5	52	1,8	20	V600, V1300	8	100
25	KRDIN25-6	6	14	7	10	9	9,5	47	3	20	V600, V1300	10	100
25	KRDIN25-8	8	16	7	10	11,5	11,5	49,5	2,5	20	V600, V1300	10	100
25	KRDIN25-10	10	17	7	10	13,5	13,5	51,5	2,4	20	V600, V1300	10	100
25	KRDIN25-12	12	19	7	10	14,5	14,5	52,5	2,1	20	V600, V1300	10	100
35	KRDIN35-6	6	17	8,2	12,5	7,5	8	49,5	4,1	20	V600, V1300	12	100
35	KRDIN35-8	8	17	8,2	12,5	11,5	11,5	53,5	4,1	20	V600, V1300	12	50
35	KRDIN35-10	10	19	8,2	12,5	13,5	13,5	55,5	3,7	20	V600, V1300	12	50
35	KRDIN35-12	12	21	8,2	12,5	14,5	14,5	56,5	3,3	20	V600, V1300	12	50
50	KRDIN50-6	6	20	10	14,5	11,5	11,5	63,5	4,3	28	V600, V1300	14	50
50	KRDIN50-8	8	20	10	14,5	11,5	11,5	63,5	4,3	28	V600, V1300	14	50
50	KRDIN50-10	10	22	10	14,5	13,5	13,5	65,5	3,9	28	V600, V1300	14	50
50	KRDIN50-12	12	24	10	14,5	14,5	14,5	66,5	3,6	28	V600, V1300	14	50
50	KRDIN50-16	16	28	10	14,5	17,5	17,5	69,5	3,1	28	V600, V1300	14	50
70	KRDIN70-6	6	24	11,5	16,5	11,5	11,5	66,5	4,5	28	V600, V1300	16	25
70	KRDIN70-8	8	24	11,5	16,5	11,5	11,5	66,5	4,5	28	V600, V1300	16	25
70	KRDIN70-10	10	24	11,5	16,5	13,5	13,5	68,5	4,5	28	V600, V1300	16	25
70	KRDIN70-12	12	24	11,5	16,5	14,5	14,5	69,5	4,5	28	V600, V1300	16	25
70	KRDIN70-16	16	30	11,5	16,5	17,5	17,5	72,5	3,7	28	V600, V1300	16	25
95	KRDIN95-8	8	28	13,5	19	13,5	13,5	78,5	5	35	V600, V1300	18	25
95	KRDIN95-10	10	28	13,5	19	13,5	13,5	78,5	5	35	V600, V1300	18	25
95	KRDIN95-12	12	28	13,5	19	14,5	14,5	79,5	5	35	V600, V1300	18	25
95	KRDIN95-16	16	32	13,5	19	17,5	17,5	82,5	4,4	35	V600, V1300	18	25
120	KRDIN120-10	10	32	15,5	21	13,5	13,5	83,5	5	35	V600, V1300	20	20
120	KRDIN120-12	12	32	15,5	21	14,5	14,5	84,5	5	35	V600, V1300	20	20
120	KRDIN120-16	16	32	15,5	21	17,5	17,5	87,5	5	35	V600, V1300	20	20
120	KRDIN120-20	20	38	15,5	21	20,5	20,5	90,5	4,1	35	V600, V1300	20	20
150	KRDIN150-10	10	34	17	23,5	13,5	13,5	91,5	6	35	V600, V1300	22	20
150	KRDIN150-12	12	34	17	23,5	14,5	14,5	92,5	6	35	V600, V1300	22	20
150	KRDIN150-16	16	34	17	23,5	17,5	17,5	95,5	6	35	V600, V1300	22	20
150	KRDIN150-20	20	40	17	23,5	20,5	21,5	98,5	5,2	35	V600, V1300	22	20
185	KRDIN185-10	10	37	19	25,5	13,5	13,5	95,5	6	40	V1300, V250	25	10
185	KRDIN185-12	12	37	19	25,5	13,5	13,5	95,5	6	40	V1300, V250	25	10
185	KRDIN185-16	16	37	19	25,5	17,5	17,5	99,5	6	40	V1300, V250	25	10
185	KRDIN185-20	20	40	19	25,5	20,5	21,5	102,5	5,7	40	V1300, V250	25	10
240	KRDIN240-10	10	42	21,5	29	14,5	14,5	117,5	7,1	40	V1300, V250	28	10
240	KRDIN240-12	12	42	21,5	29	14,5	14,5	106,5	7,1	40	V1300, V250	28	10
240	KRDIN240-16	16	42	21,5	29	17,5	17,5	109,5	7,1	40	V1300, V250	28	10
240	KRDIN240-20	20	45	21,5	29	20,5	21,5	112,5	6,5	40	V1300, V250	28	10
300	KRDIN300-12	12	48	24,5	32	17,5	17,5	117,5	7	50	V1300, V250	32	5
300	KRDIN300-16	16	48	24,5	32	17,5	17,5	117,5	7	50	V1300, V250	32	5
300	KRDIN300-20	20	48	24,5	32	20,5	21,5	120,5	7	50	V1300, V250	32	5
400	KRDIN400-12	12	55	27,5	38,5	23,5	17,5	138,5	10,4	70	V1300, V250	38	5
400	KRDIN400-16	16	55	27,5	38,5	23,5	17,5	138,5	10,4	70	V1300, V250	38	5
400	KRDIN400-20	20	55	27,5	38,5	23,5	21,5	138,5	10,4	70	V1300, V250	38	5
500	KRDIN500-20	20	60	31	42	23,5	21,5	148,5	10,5	70	V250	42	2
625	KRDIN625-20	20	63	34,5	44	23,5	21,5	158,5	9,3	80	V250	44	2
800	KRDIN800-20	20	75	40	52	23,5	21,5	188,5	11,6	100	V1470	52	1
1000	KRDIN1000-20	20	85	44	58	23,5	21,5	188,5	13,2	100	V1470	58	1

Al-Cu bimetallic through connectors 10 - 240 mm²

- Connect Al winding conductors to Cu stranded and flexible conductors.
- Al-range winding 20-310 mm². Cu-range 10-185 mm².

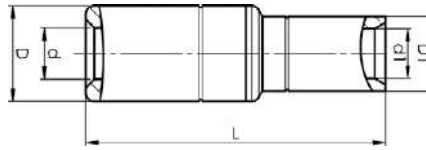

Stranded Al mm ²	Conductor Cu mm ²	Winding mm ²	Name	d mm	d1	D	D1	L	s	s1	Tool	Die (Cu)	Matrix and Punch (Al)	Pcs/pack
16-25	10-16	-	AKS1625-1016	6,2	6	8,3	7,5	36,5	19	17	V600	EW1025	TBKA9-11,5	48
30	10	20-40	AKS30L-10	7,5	4,9	13	7,9	48,5	29	16	V600, V1300	B8	13P13M2/D2	50
30	16	20-40	AKS30L-16	7,5	5,9	13	8,9	48,5	29	17	V600, V1300	B9L	13P13M2/D2	50
35	10	35-50	AKS35L-10	8,5	4,9	20	7,9	69	45	16	V1300	B8	13P20M2/D2	5
35	16	35-50	AKS35L-16	8,5	5,9	20	8,9	69	45	17	V1300	B9L	13P20M2/D2	5
35	25	35-50	AKS35L-25	8,5	7,9	20	10,9	74	45	20	V1300	B11L	13P20M2/D2	5
50	10	50-70	AKS50L-10	9,6	4,9	20	7,9	69	45	16	V1300	B8	13P20M2/D2	5
50	16	50-70	AKS50L-16	9,6	5,9	20	8,9	69	45	17	V1300	B9L	13P20M2/D2	5
50	25	50-70	AKS50L-25	9,6	7,9	20	10,9	74	45	20	V1300	B11L	13P20M2/D2	5
50	35	50-70	AKS50L-35	9,6	8,8	20	12,8	79	45	21	V1300	B13L	13P20M2/D2	5
50	50	50-70	AKS50L-50	9,6	10,8	20	14,3	83,5	45	25	V1300	B14,5L	13P20M2/D2	5
70	35	70-100	AKS70L-35	11,3	8,8	20	12,8	79	45	21	V1300	B13L	13P20M2/D2	5
70	50	70-100	AKS70L-50	11,3	10,8	20	14,3	83,5	45	25	V1300	B14,5L	13P20M2/D2	5
70	70	70-100	AKS70L-70	11,3	12,8	20	16,8	85,5	45	27	V1300	B17L	13P20M2/D2	5
95	35	100-125	AKS95L-35	12,5	8,8	25	12,8	94,5	60	21	V1300	B13L	13P25M2/D2	5
95	50	100-125	AKS95L-50	12,5	10,8	25	14,3	99	60	25	V1300	B14,5L	13P25M2/D2	5
95	70	100-125	AKS95L-70	12,5	12,8	25	16,8	101	60	27	V1300	B17L	13P25M2/D2	5
120	50	125-160	AKS120L-50	14	10,8	25	14,3	99	60	25	V1300	B14,5L	13P25M2/D2	5
120	70	125-160	AKS120L-70	14	12,8	25	16,8	101	60	27	V1300	B17L	13P25M2/D2	5
120	95	125-160	AKS120L-95	14	14,8	25	19,8	101,5	60	27	V1300	B20L	13P25M2/D2	5
150	70	160-216	AKS150L-70	15,8	12,8	25	16,8	101	60	27	V1300	B17L	13P25M2/D2	5
150	95	160-216	AKS150L-95	15,8	14,8	25	19,8	101,5	60	27	V1300	B20L	13P25M2/D2	5
150	120	160-200	AKS150L-120	15,8	16,8	25	21,8	106,5	60	32	V1300	B22L	13P25M2/D2	5
185	95	216-270	AKS185L-95	17,6	14,8	32	19,8	100,5	60	27	V1300	B20L	13P32M2/D2	5
185	120	216-270	AKS185L-120	17,6	16,8	32	21,8	105,5	60	32	V1300	B22L	13P32M2/D2	5
185	150	216-270	AKS185L-150	17,6	18,8	32	24,8	106	60	32	V1300	B25L	13P32M2/D2	5
240	120	270-310	AKS240L-120	19,8	16,8	32	21,8	105,5	60	32	V1300	B22L	13P32M2/D2	5
240	150	270-310	AKS240L-150	19,8	18,8	32	24,8	106	60	32	V1300	B25L	13P32M2/D2	5
240	185	270-310	AKS240L-185	19,8	20,8	32	26,8	106,5	60	32	V1300	B27L	13P32M2/D2	5

s, s1 = insulation stripping length

Al-Cu terminals 16 - 1200 mm²

- Used for connection of Al conductors for apparatus outlets and busbars of Cu.
- Two crimps are needed.

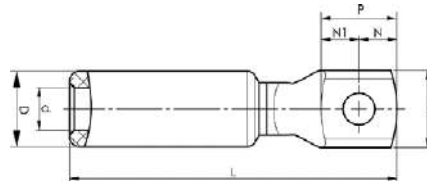

Stranded Al mm ²	Solid Al mm ²	Name	Screw	W mm	d	D	N	N1	P	L	t	s	Tool	Matrix and Punch	Note	Pcs/pack
16	25 (16)	AKK16-8	8	16	5,9	13	8,5	10	18,5	66	3	29	V600, V1300, V250	P13M/D		48
25	35	AKK25-8	8	16	6,8	13	8,5	10	18,5	66	3	29	V600, V1300, V250	P13M/D		48
25	35	AKK25-12	12	22	6,8	13	11,5	15,5	27	75	4	29	V600, V1300, V250	P13M/D		24
35	50	AKK35-8	8	25	8,5	20	12,5	12,5	25	89	5,8	45	V1300, V250	P13M/D		24
35	50	AKK35-12	12	25	8,5	20	12,5	12,5	25	89	5,8	45	V1300, V250	P13M/D		24
50	70	AKK50-8	8	25	9,6	20	12,5	12,5	25	89	5,8	45	V1300, V250	P20M/D		24
50	70	AKK50-10	10	25	9,6	20	12,5	12,5	25	89	5,8	45	V1300, V250	P20M/D		24
50	70	AKK50-12	12	25	9,6	20	12,5	12,5	25	89	5,8	45	V1300, V250	P20M/D		24
70	95	AKK70-8	8	25	11,3	20	12,5	12,5	25	89	5,8	45	V1300, V250	P20M/D		24
70	95	AKK70-10	10	25	11,3	20	12,5	12,5	25	89	5,8	45	V1300, V250	P20M/D		24
70	95	AKK70-12	12	25	11,3	20	12,5	12,5	25	89	5,8	45	V1300, V250	P20M/D		24
95	120	AKK95-8	8	25,5	12,5	25	12,5	12,5	25	108	5,7	60	V1300, V250	P20M/D		12
95	120	AKK95-10	10	25,5	12,5	25	12,5	12,5	25	108	5,7	60	V1300, V250	P20M/D		12
95	120	AKK95-12	12	25,5	12,5	25	12,5	12,5	25	108	5,7	60	V1300, V250	P20M/D		12
95	120	AKK95-16	16	30	12,5	25	15	15	30	115	6,5	60	V1300, V250	P20M/D		12
120	150	AKK120-10	10	25,5	14	25	12,5	12,5	25	108	5,7	60	V1300, V250	P25M/D		12
120	150	AKK120-12	12	25,5	14	25	12,5	12,5	25	108	5,7	60	V1300, V250	P25M/D		12
120	150	AKK120-16	16	30	14	25	15	15	30	115	6,5	60	V1300, V250	P25M/D		12
150	185	AKK150-10	10	25,5	15,8	25	12,5	12,5	25	108	5,7	60	V1300, V250	P25M/D		12
150	185	AKK150-12	12	25,5	15,8	25	12,5	12,5	25	108	5,7	60	V1300, V250	P25M/D		12
150	185	AKK150-16	16	30	15,8	25	15	15	30	115	6,5	60	V1300, V250	P25M/D		12
185	240	AKK185-10	10	30	17,6	32	15	15	30	116	6,5	61	V1300, V250	P25M/D		12
185	240	AKK185-12	12	30	17,6	32	15	15	30	116	6,5	61	V1300, V250	P25M/D		12
185	240	AKK185-16	16	30	17,6	32	15	15	30	116	6,5	61	V1300, V250	P25M/D		12
240		AKK240-10	10	30	19,8	32	15	15	30	116	6,5	61	V1300, V250	P32M/D		12
240		AKK240-12	12	30	19,8	32	15	15	30	116	6,5	61	V1300, V250	P32M/D		12
240		AKK240-16	16	30	19,8	32	15	15	30	116	6,5	61	V1300, V250	P32M/D		12
300		AKK300-12	12	37	22	36	18,5	18,5	37	154	6,5	82	V250	P36M/D		6
300		AKK300-16	16	37	22	36	18,5	18,5	37	154	6,5	82	V250	P36M/D		6
300		AKK300-20	20	37	22	36	18,5	18,5	37	154	6,5	82	V250	P36M/D		6
300		AKK300B-12	12	37	22,3	37	18,5	18,5	37	139	6,7	68	V1300, V250	P37M/D		6
300		AKK300B-16	16	37	22,3	37	18,5	18,5	37	139	6,7	68	V1300, V250	P37M/D		6
	300	AKK300-12SOLID	12	37	20	36	18,5	18,5	37	154	6,5	82	V250	P36M/D		6
	300	AKK300-16SOLID	16	37	20	36	18,5	18,5	37	154	6,5	82	V250	P36M/D		6
	300	AKK300-20SOLID	20	37	20	36	18,5	18,5	37	154	6,5	82	V250	P36M/D		6
400		AKK400-12	12	37	25	40	18,5	18,5	37	155	6,5	83	V250	P40M/D		6
400		AKK400-16	16	37	25	40	18,5	18,5	37	155	6,5	83	V250	P40M/D		6
400		AKK400-20	20	37	25	40	18,5	18,5	37	155	6,5	83	V250	P40M/D		6
400		AKK400B-12	12	37	25	37	18,5	18,5	37	139	6,7	68	V1300, V250	P37M/D		6
400		AKK400B-16	16	37	25	37	18,5	18,5	37	139	6,7	68	V1300, V250	P37M/D		6
500		AKK500A-16	16	48	28	52	26	29	55	222	9,5	110	V250	P44M/D		3
500		AKK500A-20	20	48	28	52	26	29	55	222	9,5	110	V250	P44M/D		3
500		AKK500A-1		48	28	52			70	237	9,5	110	V250	P44M/D	Unholed palm	3
500		AKK500A-2		70	28	52			70	240	12	110	V250	P44M/D	Unholed palm	3
500		AKK500B-16	16	42	28	44	21	21	42	174	10	83	V250	P2552M/D		3
500		AKK500B-20	20	42	28	44	21	21	42	174	10	83	V250	P2552M/D		3
500		AKK500B-1		42	28	44			70	202	10	83	V250	P2552M/D	Unholed palm	3
500		AKK500B-2		70	28	44			70	211	12	83	V250	P2552M/D	Unholed palm	3
630		AKK630A-1		48	32	52			70	237	9,5	110	V250	P2552M/D	Unholed palm	3
630		AKK630A-2		70	32	52			70	240	12	110	V250	P2552M/D	Unholed palm	3
800		AKK800-1		62	36	60			70	263	12	129	V1470	W60M/D	Unholed palm	1
800		AKK800-2		75	36	60			75	275	17	129	V1470	W60M/D	Unholed palm	1
1000		AKK1000-1		62	40	60			70	263	12	129	V1470	W60M/D	Unholed palm	1
1000		AKK1000-2		75	40	60			75	275	17	129	V1470	W60M/D	Unholed palm	1
1200		AKK1200		75	44	70			75	310	17	142	V1470	W70M/D	Unholed palm	1

s = strip length, t = palm thickness

Earthing and braids

Flat, flexible braids

Earthing braids with flat, twined, highly flexible Cu-conductor, uncoated 0,09 - 400 mm².



- Broad range of flexible and highly flexible flat earth braids.
- Customer unique solutions are available.
- Braids in other materials, such as stainless steel, aluminium or insulated connectors could also be provided.

Uncoated earthing braid: FJCU area (mm²) - length (mm) - Hole size

Example: FJCU50-100-8



Flat, flexible braids (tin plated)

Earthing braids with flat, twined, highly flexible Cu-conductor, tin plated 0,09 - 400 mm².



- Broad range of flexible and highly flexible flat earth braids.
- Customer unique solutions can be made.
- Braids in other material, such as stainless steel, aluminium or insulated connectors are also available.

Tin plated earthing braid: FJCUSN area (mm²) - length (mm) - Hole size

Example: FJCUSN50-100-8



Round, flexible connections (un-insulated)

Un-insulated slacks with many possibilities to connect Elpress terminals.

Such as KSF/KRF Cu tube terminal range, AlCu bi-metallic range

AKK/AKS or Al range AK/AS.

Round, twined, highly flexible Cu-conductor, tin plated or uncoated, 0,06 - 600 mm².



- Broad range of flexible and highly flexible flat earth braids.
- Customer unique solutions available.
- Braids in other materials, such as stainless steel, aluminium or insulated connectors are also available.

Uncoated earthing braid (round): FLCU area (mm²) - length (mm) - Hole size

Example: FLCU50-100-8



Round, flexible connections (un-insulated, tin plated)

Un-insulated slacks with many possibilities to connect Elpress terminals.
Such as KSF/KRF Cu tube terminal range, AlCu bi-metallic range AKK/AKS
or Al range AK/AS.

Round, twined, highly flexible Cu-conductor, tin plated or uncoated, 0,06 - 600 mm².



- Broad range of flexible and highly flexible flat earth braids.
- Customer unique solutions could be made.
- Braids in other materials, such as stainless steel, aluminium or insulated connectors could also be provided.

Tin plated earthing braid (round): FLCUSN area (mm²) - length (mm) - Hole size

Example: FLCUSN50-100-8



Round, flexible connections (insulated)

Insulated slacks with many possibilities to connect Elpress terminals.

Such as KSF/KRF Cu tube terminal range, AlCu bi-metallic range AKK/AKS
or Al range AK/AS.

Round, twined, highly flexible Cu-conductor, tin plated or uncoated, 0,06 - 600 mm².



- Customer unique slack, possible to make according to customer requirements.
- Insulated braids in other materials, such as stainless steel, aluminium or insulated connectors could also be provided.

Insulated, uncoated slacks: FKCU area (mm²) - length (mm) - Hole size

Example: FKCU50-100-8



Slacks

Type	Conductor mm ²	Hole	Description	Used with (combine terminals freely)
KRF	CU 16-800	M range	Terminal	CU conductors
KSF	CU 16-800		Connector	CU conductors
AKS	AL/CU 10-400/10-300	M range	Connector	CU and/or AL conductors
AKK	AL 16-1200		Terminal	AL conductors
AKP	AL 16-1200	M range	Pin terminal	AL conductors
KR	CU 0,75-10		Terminal	CU conductors
KS	CU 0,75-10		Connector	CU conductors

Common information













System Elpress

System Elpress consists of connectors and tools tested together for optimum connection result. The System concept makes you as a customer able to feel secure when using our system and to be sure a safe connections is made when Elpress products are used correctly.

Hydraulic crimp systems

Elpress hydraulic crimp systems crimp from 10 to 1200 mm². The systems consist of pumps and crimp heads that can be freely combined or with complete hand-held tools, where these devices are integrated. Wide range of accessories available for crimping, pre-rounding, cutting etc. Together with the matching terminals, the complete system is formed. Both pumps and hand-held tools have, with a few exceptions, quick feed function that means crimping can begin after a few pump strokes.

The systems have a built-in ratchet lock that ensures that an initial crimp is completed and thus produces results with the best characteristics. Pumps that can be connected to the different crimp heads provide the option of comfortable work in difficult situations and with maximum flexibility.

System	Material	mm ²																												
		0,25	0,5	0,75	1,5	2,5	4	6	10	16	25	35	50	70	95	120	150	185	240	300	400	500	630	800	1000	1200				
	DKB0325	Cu	[Crimping range]																											
	DKB0760	Cu		[Crimping range]																										
	GWB4099/ GWB4099C	Cu			[Crimping range]																									
	ES2258	Cu				Cut 6-16 mm ²																								
	T2258	Cu				Cut 6-16 mm ²																								
	600	Cu						winding 25-185 mm ²																						
		Al																												
	1300	Cu							winding 25-343 mm ²																					
		Al																												
	250	Cu								winding 180-730 mm ²																				
		Al																												
	350	Cu																			winding 340-630 mm ²									
	1470	Cu																												
		Al																												

-  ES2258LB5 tap changers (CU) 30A
-  ES2258LB7 tap changers (CU) 63A
-  PVL130L tap changers (CU) 30A, 63A

Manual crimping tools for off-load transformer tap changers



ES2258LB5



A tested and certified crimping tool for solid copper wires of diameters 2.5-2.8 mm in combination with 5 mm transformer tap changer connectors.

Name	Crimp geometry	Net weight (kg)	Length mm	Width
ES2258LB5	Hexagonal	0,645	300	30

Crimp geometry



ES2258LB7



A tested and certified crimping tool for solid copper wires of diameter 4.0 mm in combination with 7 mm transformer tap changer connectors.

Name	Crimp geometry	Net weight (kg)	Length mm	Width
ES2258LB7	Hexagonal	0,645	300	30

Crimp geometry



Manual crimping tools for Cu connectors



DKB0325



Tested and certified mechanical hand tool for indent crimping Cu terminals 0.25-2.5 mm².

mm ²	Name	Crimp geometry	Net weight (kg)	Length mm	Width
0,25-2,5	DKB0325	Tab	0,444	192	66

Crimp geometry



DKB0760



Tested and certified mechanical hand tool for indent crimping Cu terminals 0.75-6 mm².

mm ²	Name	Crimp geometry	Net weight (kg)	Length mm	Width
0,75-6	DKB0760	Tab	0,445	192	66

Crimp geometry



GWB4099 and GWB4099C



Tested and certified mechanical Miniforce hand tool for W crimping un-insulated ring, fork and pin terminals as well as tube terminals and through connectors type KR and KS 4-10 mm².

mm ²	Name	Crimp geometry	Net weight (kg)	Length mm	Width
4-10	GWB4099	W	0,542	203	76
4-10	GWB4099C	W	0,560	256	80

Crimp geometry





ES2258



Tested and certified mechanical hand-held tool for crimping Cu-terminals, type CUT 6-16 mm² and KR/KS 4-10 mm².

mm ²	Name	Crimp geometry	Net weight (kg)	Length mm	Width
4-16	ES2258	Hexagonal	0,660	300	30

Crimp geometry



T2258



Tested and certified mechanical hand-held tool for crimping Cu-terminals, type CUT 6-16 mm² and KR/KRF/KS/KSF 4-16 mm².

mm ²	Name	Crimp geometries	Net weight (kg)	Length mm	Width
4-16	T2258	Punch, Hexagonal	0,650	304	30

Crimp geometries



Battery powered crimp tool for crimping off-load transformer tap changers



PVL130L



Tested and certified tool with a high performance Li-Ion battery that streamlines your work with its improved battery capacity. To be used for crimping of standard tap changers for 30A and 63 A.

Properties:

- easy-to-open crimp head for rapid die change
- slim ergonomic design - good accessibility even in confined areas
- Li-Ion battery (10.8 V, 2,0 Ah), charge time approx. 40 minutes
- rapid crimp operation 2 seconds (dependent on material)
- dies for crimping of special through connectors

Name	Crimp geometry	Net weight (kg)	Length mm	Width	Height	Notes
PVL130L	Hexagonal	1,50	330	85	60	
PVL130LDBKIT		1,69				Includes PVL130L , LB5, LB7 and battery with charger

Crimp geometry



Dies for PVL130L

Dies for crimping solid copper wires in combination with transformer tap changer connectors.

- Designed for standardized 30 A and 63 A tap changers.
- Hexagonal crimp geometry.



ø	Name	Number of crimps	Die holder required	Note
5	LB5	1	No	For standardized 30 A and 63 A tap changers
7	LB7	1	No	For standardized 30 A and 63 A tap changers

Battery powered tool PVL350 for crimping Cu-terminals



PVL350 - Elpress Mini

Battery-powered tool for crimping tube terminals and through connectors of type KRF/KSF up to 70 mm² with special "MB" dies.



Properties:

- opening head for easy die changes and good accessibility
- High-performance 10.8 V Li-Ion battery with indication of charge status
- very good accessibility and ergonomics
- opening, rotatable "flip top" head for easy die changes and slim crimp head for good accessibility
- rapid crimp sequence 3-4 seconds
- approx. 100-180 crimps/battery charges (depending on temp, frequency etc.)
- 2-component housing with grip-friendly protection. One-handed operation for easy control of all tool functions
- Lightweight, and rapid crimping sequence for maximum efficiency
- Automatic return of the dies when crimping is complete

Crimp geometries

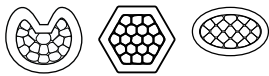

mm ²	Name	Crimp geometries	Net weight (kg)	Length mm	Width	Height
4-70	PVL350	Punch, Hexagonal, Oval	1,60	360	116	75

Crimp dies to PVL350 (KR/KRF, KS/KSF, CUT, C-sleeves)

Supplied in pairs.

For hexagonal crimping of Cu 4-70 mm². CUT sleeves 6-16 mm² crimped with MB4016. C-sleeves 6-25 mm² are crimped with MBC5 and MBC6.



Die pair MB11 for PVL350.

mm ²	Name	Number of crimps	Net weight (kg)	Used for
10 - 16	MB8	1	0,086	KR/KS 10 mm ² and KR/D/KSD 10-16 mm ²
16 - 25	MB9	1	0,085	KRF/KSF 16 mm ² and KR/D/KSD 25 mm ²
25 - 35	MB11	2	0,083	KRF/KSF 25 mm ² and KR/D/KSD 35 mm ²
35	MB13	2	0,081	KRF/KSF 35 mm ²
50	MB14,5	2	0,080	KRF/KSF 50 mm ²
70 - 95	MB17	3	0,075	KRF/KSF 70 mm ² and KR/D/KSD 95 mm ²
4-10	MB4016	1	0,082	KR/KS 4-10 mm ² , CUT sleeves 6-16 mm ²

System 600 for crimping Cu and Al terminals



CE

V600



Tested and certified crimp head for crimping Cu terminals, type KR/KS 10 mm², KRF/KSF 16-150 mm², Cu windings 25-185 mm², Al-terminals 16-25 mm² (-35 solid), C-sleeves 6/6-50/50 mm².

Can be used together with the foot pump P4000 or the electrically powered pump PS710E/R (battery powered version of PS710E is also available).

Properties:

- working pressure 63 MPa (630 bar)
- crimp force 55 kN
- robust fabric bag with room for 10 dies included

mm ²	Name	Crimp geometries	Net weight (kg)	Length mm	Width	Height
10-150	V600	Punch, Hexagonal, Oval	2,45	189	74	53

Crimp geometries



CE

V611



Tested and certified hydraulic hand-held tool for crimping Cu-terminals, type KR/KS 10 mm², KRF/KSF 16-150 mm², Cu windings 25-185 mm², Al-terminals 16-25 mm² (-35 solid), C-sleeves 6/6-50/50 mm².

Properties:

- fast-feed to crimp engagement provides short crimp times
- crimp force 60 kN
- delivered in sturdy textile bag

mm ²	Name	Crimp geometries	Net weight (kg)	Length mm	Width	Height
10-150	V611	Punch, Hexagonal, Oval	2,60	425	115	53

Crimp geometries





PVX611/PVX611DB



Tested and certified battery-powered crimp tool for crimping Cu-terminals, type KR/KS 10 mm², KRF/KSF 16-150 mm², Cu windings 25-185 mm², Al-terminals 16-25 mm² (-35 solid), C-sleeves 6/6-50/50 mm². PVX611DB has an extra battery.

Properties:

- protects against dirt and dust through the closed chassis
- ergonomic design ensures optimum balance in the user's hand
- swivel opening crimp fork
- crimp force control using pressure monitoring
- one handed operation for easy work
- LED lighting for easier work
- fast-forward feeding for more efficient crimping
- display with information about the tool and service intervals
- crimp monitoring via display when the correct pressure/complete crimping is not achieved (warning light LED and signal)
- Li-Ion battery included (18 V, 2,0 Ah)

Crimp geometries

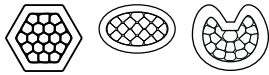

mm ²	Name	Crimp geometries	Net weight (kg)	Length mm	Width	Height
10-150	PVX611	Punch, Hexagonal, Oval	5,50	414	116	75
10-150	PVX611DB	Punch, Hexagonal, Oval	5,85	414	116	75

Accessories for system 600

- For crimping Cu terminals 10-150 mm² or Cu windings 25-185 mm².
- The KB/TB dies below are intended for Cu-terminals, type KR/KRF and KS/KSF, together with both stranded and multi-stranded Cu conductors of Class 2 and 5 respectively according to IEC 60228.
- TB/KB (L) are intended for Cu-windings.
- Be sure to use dies exactly matching the terminal.

Crimp dies for KRF/KSF

For Cu-terminals, hexagonal crimping. Supplied in pairs.
The TB dies below are intended for Cu-terminals, type KRF/KSF, together with Cu conductor according to IEC 60228.



Die pair TB9-13 for V600, V611 and PVX611.



Die pair KB22 for V600, V611 and PVX611.

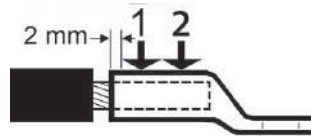

Crimp sequence for two crimps.

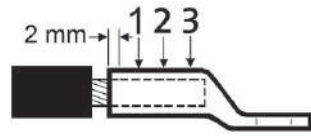

Crimp sequence for three crimps.

mm ²	Name	Number of crimps	Net weight (kg)	Die holder required	Note
10 / 70	TB8-17	1, 2	0,138	No	Used for KRF/KSF 10 mm ² and 70 mm ² respectively
16 / 35	TB9-13	1	0,149	No	Used for KRF/KSF 16 mm ² and 35 mm ² respectively
25 / 50	TB11-14,5	1	0,149	No	Used for KRF/KSF 25 mm ² and 50 mm ² respectively
10 / 95	TB7-20	1, 2	0,135	No	Used for KRF/KSF 10 mm ² and 95 mm ² respectively
120	KB22	3	0,150	No	
150	KB25	3	0,147	No	

Crimp dies for winding conductors KRF/KSF (L)

For Cu-terminals, hexagonal crimping. Supplied in pairs.
The TB dies below are intended for Cu-terminals, type KRF/KSF (L), together with Cu winding conductors.



mm ²	Winding mm ²	Name	Number of crimps	Net weight (kg)	Die holder required
25	30-47	TB11L	1	0,149	No
35	45-70	TB13L	1	0,147	No
50	69-103	TB14,5L	1	0,144	No
70	100-120	TB17L	2	0,134	No
95	113-161	TB20L	2	0,131	No
120	145-185	KB22L	3	0,139	No

Crimp dies for Al and Cu, V600 system

For crimping 16-25 mm² Al and 10-16 mm² Cu.
Used in the V600 system.



Punch crimping.

The dies below are intended to be used together with Cu/Al conductors according to IEC 60228.



mm ²	Name	Number of crimps	Net weight (kg)	Note
Cu 10 - 16, / AL 16 - 25	TBKA9-11,5	1	0,140	Used to crimp AS1625 and AKS1625-1016

System 1300 for crimping Cu and Al terminals



CE

V1300



V1300 crimp head V1300A

Crimp geometries

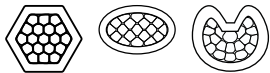

Tested and certified crimp head for crimping Cu-terminals, type KR/KRF and KS/KSF 10-400 mm², Cu-windings 25-343 mm², Al-terminals 16-400 mm² (-240 solid), C sleeves up to 240 mm² total area (C95-120). Used in conjunction with foot pump P4000 or the electrically powered pump P5710 (battery powered version of P5710E is also available).

Properties:

- crimps Cu-conductors of type KRF-L up to 240 mm²
- working pressure 63 MPa (630 bar)
- crimp force 130 kN (13 tons)
- versatile and easy-to-use steel crimp head

mm ²	Name	Crimp geometries	Net weight (kg)	Length mm	Width	Height	Note
10-400	V1300	Hexagonal, Oval, Punch	3,46	270	82	75	
10-400	V1300A	Hexagonal, Oval, Punch	3,40	270	82	75	Closed fork design, for longer durability



CE

V1300L



Crimp geometries

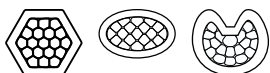

Tested and certified crimp head for crimping Cu-terminals, type KR/KRF and KS/KSF 10-400 mm², Cu-windings 25-343 mm², Al-terminals 16-400 mm² (-240 solid), C sleeves up to 240 mm² total area (C95-120). Used in conjunction with foot pump P4000 or the electrically powered pump P5710 (battery powered version of P5710E is also available).

Properties:

- crimps Cu-conductors of type KRF-L up to 240 mm²
- equipped with protective rubber coating on top of the fork and oil spray safety protection cap
- working pressure 63 MPa (630 bar)
- crimp force 130 kN (13 tons)
- versatile and easy-to-use steel crimp head

mm ²	Name	Crimp geometries	Net weight (kg)	Length mm	Width	Height
10-400	V1300L	Hexagonal, Oval, Punch	3,40	270	82	75



PVX1300/PVX1300DB

Tested and certified battery-powered crimp gun for contact crimping Cu-terminals, type KR/KRF and KS/KSF 10-400 mm², Cu-windings 25-343 mm², Al-terminals 16-400 mm² (-240 solid), C sleeves up to 240 mm² total area (C95-120).



Properties:

- crimps Cu-conductors of type KRF-L up to 240 mm²
- ergonomic design ensures optimum balance in the user's hand
- crimp monitoring with warning light (LED) and signal when the correct pressure/full crimp is not achieved
- LED work lighting
- possibility of documentation of each crimp for unique service control
- crimp force 124 kN (13 tons)
- crimps/charging: 60-120 depending on size and temperature
- crimp time: 4-12s depending on size
- usage temperature -20°C to +40°C
- Li-Ion Makita, 5.0 Ah, 18V
- charger Li-Ion Makita, charging time 22 min

Crimp geometries

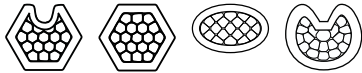

mm ²	Name	Crimp geometries	Net weight (kg)	Length mm	Width	Height
10-400	PVX1300	Punch, Dual, Hexagonal, Oval	6,70	412	319	75
10-400	PVX1300DB	Punch, Dual, Hexagonal, Oval	7,30	412	319	75
10-400	PVX1300-ADV	Punch, Dual, Hexagonal, Oval	14,2	412	319	75
10-400	PVX1300DB-ADV	Punch, Dual, Hexagonal, Oval	14,2	412	319	75



V1300C2

Crimp head for crimping Cu-terminals, type KR/KRF and KS/KSF 10-400 mm² and Cu-windings 25-343 mm². Used in conjunction with foot pump P4000 or battery and mains powered pump PS710 (battery powered version of PS710E is also available).



Properties:

- working pressure 63 MPa (630 bar)
- crimp force 130 kN
- versatile and easy to use

mm ²	Name	Crimp geometries	Net weight (kg)	Length mm	Width	Height
10-400	V1300C2	Hexagonal, Oval	4,60	297	145	75

Crimp head V1300C2 with dies.

Crimp geometries

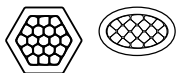



PVX1300C2/PVX1300C2DB

Tested and certified battery-powered crimp gun for crimping Cu-terminals, type KR/KRF and KS/KSF 10-400 mm², Cu-windings 25-343 mm² and C-sleeves up to 240 mm² total area (C95-120).



Properties:

- ergonomic design ensures optimum balance in the user's hand
- crimp monitoring with warning light (LED) and signal when the correct pressure/full crimp is not achieved
- LED work lighting
- possibility of documentation of each crimp for unique service control
- crimp force 124 kN (13 tonnes)
- usage temperature -20°C to +40°C
- Li-Ion Makita, 5.0 Ah, 18V
- charger Li-Ion Makita, charging time 22 min

PVX1300C2 crimp gun with C-Crimp head.

Crimp geometries



mm ²	Name	Crimp geometries	Net weight (kg)	Length mm	Width	Height
10-400	PVX1300C2	Dual, Hexagonal, Oval	7,50	399	319	75
10-400	PVX1300C2DB	Dual, Hexagonal, Oval	8,10	399	319	75
10-400	PVX1300-ADV	Punch, Dual, Hexagonal, Oval	14,2	412	319	75
10-400	PVX1300DB-ADV	Punch, Dual, Hexagonal, Oval	14,2	412	319	75

Accessories for system 1300

- The B (L) dies below are intended for Cu-terminals, type KR/KRF and KS/KSF, together with Cu winding conductors.
- Be sure to use dies exactly matching the terminal.

Pre-rounding of Cu

For pre-rounding copper winding conductors to fit the connector in question.



mm ²	Winding mm ²	Matrix	Punch	Number of crimps	Matrix holder required	Punch holder required
25	30-47	13R8ML	13R8DL	1	No	No
35	45-70	13R9ML	13R9DL	1	No	No
50	69-103	13R11ML	13R11DL	1	No	No
70	100-120	13R13ML	13R13DL	1	No	No
95	113-161	13R15ML	13R15DL	1	No	No
120	145-185	13R17ML	13R17DL	1	No	No
150	180-220	13R19ML	13R19DL	1	No	No

Crimp dies for Cu

Supplied as a pair. For hexagonal crimping of Cu terminals and connectors. May be used on flexible (class 5) as well as stranded (class 2) conductors and for winding conductors in Transformer manufacture.



mm ²	Winding mm ²	Name	Number of crimps	Die holder required
10		13B8	1	No
16		13B9L	1	No
25	30-47	13B11L	1	No
35	45-70	13B13L	1	No
50	69-103	13B14,5L	1	No
70	100-120	13B17L	1	No
95	113-161	13B20L	1	No
120	145-185	13B22L	2	No
150	180-220	13B25L	2	No
185	220-265	13B27L	2	No
240	302-343	13B30L	2	No

Crimp dies for crimping of KS-PL

For crimping of parallel copper through connectors for transitions between winding- and flexible conductors.



mm ²	Winding mm ²	Matrix	Punch	Number of crimps	Matrix holder required	Punch holder required
50	69-103	13P14,5ML	13P14,5DL	1	No	No
70	100-120	13P17ML	13P17DL	1	No	No
95	113-161	13P20ML	13P20DL	1	No	No
120	145-185	13P22ML	13P22DL	1	No	No
150	180-220	13P25ML	13P25DL	1	No	No
185	220-265	13P27ML	13P27DL	1	No	No
240	302-343	13P30ML	13P30DL	1	No	No

Crimp dies (C fork) for Cu winding

Supplied in pairs.

For Cu-terminals with winding conductors, hexagonal crimping. Used without a die holder.

May be used on flexible (class 5) as well as stranded (class 2) conductors and for winding conductors in Transformer manufacture.

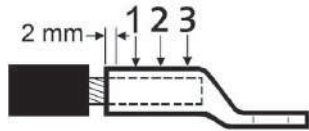

Crimp sequence for three crimps.

mm ²	Name	Number of crimps	Net weight (kg)	Die holder required
50	13CB14,5L	1	0,500	No
70	13CB17L	1	0,480	No
95	13CB20L	1	0,497	No
120	13CB22L	2	0,537	No
150	13CB25L	2	0,500	No
185	13CB27L	2	0,478	No
240	13CB30L	2	0,500	No

Pre-rounding of Al

For pre-rounding aluminium winding conductors to fit the connector in question.



Stranded Al mm ²	Winding mm ²	Matrix	Punch	Number of crimps	Matrix holder required	Punch holder required
30	20-40	13R7.5ML-AL	13R7.5DL-AL	1	No	No
35	35-50	13R8ML-AL	13R8DL-AL	1	No	No
50	50-70	13R9ML-AL	13R9DL-AL	1	No	No
70	70-100	13R10ML-AL	13R10DL-AL	1	No	No
95	100-125	13R12ML-AL	13R12DL-AL	1	No	No
120	125-160	13R13ML-AL	13R13DL-AL	1	No	No
150	160-216	13R15ML-AL	13R15DL-AL	1	No	No
185	216-270	13R17ML-AL	13R17DL-AL	1	No	No
240	270-310	13R19ML-AL	13R19DL-AL	1	No	No

Punch and matrix for Al

For crimping of the aluminium side of the bimetallic connector.



Stranded Al mm ²	Winding mm ²	Matrix	Punch	Number of crimps	Matrix holder required	Punch holder required
30	20-40	13P13M2	13P13D2	1	No	No
35-70	35-50, 50-70, 70-100	13P20M2	13P20D2	1	No	No
95-150	100-125, 125-160, 160-216	13P25M2	13P25D2	1	No	No
185-240	216-270, 270-310	13P32M2	13P32D2	1	No	No



Storage boxes for system 1300

Carry box which takes the tool V1300/V1300L and all necessary accessories to crimp Elpress Cu- and Al terminals.

Properties:

- steel reinforced plywood
- polyethylen insert material
- sturdy, form cut inserts



Name	Net weight (kg)	Length mm	Width	Height	Notes
LV1300L	3,80	570	435	130	Empty storage box wit slots for crimp head V1300L and accessories
L1300 CU-ALU	3,76	570	435	175	Empty storage box with slots for Cu- and AL-accessories

System 250 for crimping Cu and Al terminals



CE



V250

Tested and certified crimp head for crimping Cu-terminals, type KRF/KSF 10-800 mm², Cu-windings 25-730 mm², Al-terminals 16-630 mm² (-300 solid), C sleeves 6/6-50/50 mm². Used in conjunction with foot pump P4000 or the electrically powered pump PS710 (battery powered version of PS710E is also available).

Properties:

- working pressure 63 MPa (630 bar)
- crimp force 250kN (25 tons)
- large crimp area, 10-800 mm²

mm ²	Name	Crimp geometries	Net weight (kg)	Length mm	Width	Height
10-800	V250	Punch, Hexagonal, Oval	4,68	280	111	74

Crimp geometries

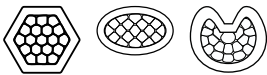

CE



V250L

Tested and certified crimp head for crimping Cu-terminals, type KRF/KSF 10-800 mm², Cu-windings 25-730 mm², Al-terminals 16-630 mm² (-300 solid), C sleeves 6/6-50/50 mm². Used in conjunction with foot pump P4000 or the electrically powered pump PS710 (battery powered version of PS710E is also available).

Properties:

- equipped with protective rubber coating on top of the fork and oil spray safety protection cap
- working pressure 63 MPa (630 bar)
- crimp force 250kN (25 tons)
- large crimp area, 10-800 mm²

mm ²	Name	Crimp geometries	Net weight (kg)	Length mm	Width	Height
10-800	V250	Punch, Hexagonal, Oval	4,68	280	111	74

Crimp geometries



Accessories for system 250

- The B (L) dies below are intended for Cu-terminals, type KR/KRF and KS/KSF, together with Cu winding conductors.
- Be sure to use dies exactly matching the terminal.

Pre-rounding of Cu

For pre-rounding copper winding conductors to fit the connector in question.



mm ²	Winding mm ²	Matrix	Punch	Number of crimps	Matrix holder required	Punch holder required
185	220-265	25R21ML	25R21DL	1	No	No
240	302-343	25R24ML	25R24DL	1	No	No
300	340-400	25R26ML	25R26DL	1	No	No
400	412-500	25R30ML	25R30DL	1	No	No
500	500-580	25R33ML	25R33DL	1	No	No
630	630-730	25R39ML	25R39DL	1	No	No

Crimp dies for Cu

Supplied in pairs.

For hexagonal crimping of Cu terminals and connectors.

May be used on flexible (class 5) as well as stranded (class 2) conductors and for winding conductors in Transformer manufacture.



mm ²	Winding mm ²	Name	Number of crimps	Die holder required
150	180-220	B2525L	1	No
185	220-265	B2527L	1	No
240	302-343	B2530L	1	No
300	340-400	B2532L	1	No
400	412-500	B2538L	2	No
500	500-580	B2542L	2	No
630	630-730	B2550L	3	No



Storage box for system 250

Carry box which takes the tool V250/V250L and all necessary accessories to crimp Elpress Cu- and Al terminals.

Properties:

- steel reinforced plywood
- polyethylen insert material
- sturdy, form cut inserts



Name	Net weight (kg)	Length mm	Width	Height
LV250L	3,76	570	435	130

System 350 for crimping Cu-terminals



DV350



Tested and certified crimp head for crimping Cu-terminals, type KRF/KSF 300-630 mm², Cu-windings 340-730 mm². Used in combination with the electrically powered pump PS710E, or foot pump P4000.

Properties:

- working pressure 63 MPa (630 bar)
- crimp force 350kN (35 tonnes)
- large crimp area, 300-630 mm²

mm ²	Name	Crimp geometries	Net weight (kg)	Length mm	Width	Height
300-630	DV350	Dual, Hexagonal	21,0	356	150	210

Crimp geometries

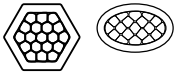

Accessories for crimping Cu with DV350 (winding)

- The B (L) dies below are intended for Cu-terminals, type KR/KRF and KS/KSF, together with Cu winding conductors.
- Be sure to use dies exactly matching the terminal.

Crimp dies for Cu

Supplied in pairs.

For hexagonal crimping of Cu terminals and connectors.

May be used on flexible (class 5) as well as stranded (class 2) conductors and for winding conductors in Transformer manufacture.



mm ²	Winding mm ²	Name	Crimp geometry
240	302-343	B3530L	Hexagonal
300	340-400	B3532L	Hexagonal
400	412-500	B3538L	Hexagonal
500	500-580	B3542L	Hexagonal
630	630-730	B3550L	Hexagonal

Pre-rounding of Cu

For pre-rounding copper winding conductors to fit the connector in question.



mm ²	Winding mm ²	Matrix	Punch
300	340-400	35R26ML	35R26DL
400	412-500	35R30ML	35R30DL
500	500-580	35R33ML	35R33DL
630	630-730	35R39ML	35R39DL

System 1470 for crimping Cu and Al terminals



CE

V1470



Tested and certified crimp head for contact crimping Cu-terminals, type KRF/KSF 500-800 mm², KRD/KSD, KRT/KST 500-1000 mm², Al-terminals 800-1200 mm², C-sleeves 245-540 mm² (C150-185 och C240-300). Used in conjunction with foot pump P4000 or electrically powered pump PS710.

Properties:

- working pressure 63 MPa (630 bar)
- crimp force 400 kN
- supplied in plywood box

mm ²	Name	Crimp geometries	Net weight (kg)	Length mm	Width	Height
500-1200	V1470	Punch, Hexagonal, Oval	20,76	510	235	103

Crimp geometries

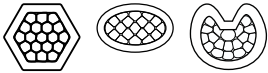

Accessories for system 1470

Punch and Matrix

For Al-terminals, indented crimping.
Use matrix holder V1471.

When crimping Al-terminals, two crimps are always required.



Matrix holder V1471, Matrix W60M, punch W60D.

Stranded Al mm ²	Matrix	Punch	Number of crimps	Matrix holder required	Punch holder required
800-1000	W60M	W60D	2	Yes	No
1200	W70M	W70D	2	Yes	No

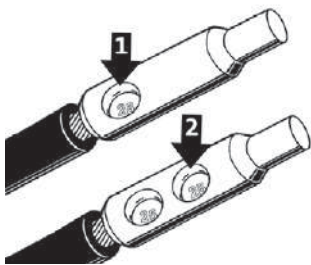

Crimp sequence

Crimp dies for KRF/KSF, KR D/KSD and KRT/KST

Supplied in pairs.

For Cu-terminals, hexagonal crimping. When crimping Cu-terminals, two crimps are always required.

May be used on flexible (class 5) as well as stranded (class 2) conductors and for winding conductors in Transformer manufacture.



B4040.

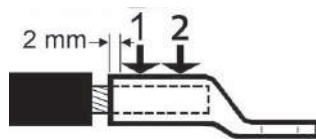

Crimp sequence for two crimps.

mm ²	Name	Number of crimps	Note
500	B4040	2	For stranded Cu-conductors: KR D/KSD, KRT/KST 500 mm ²
500	B4042	2	For multi strand Cu-conductors: KRF/KSF 500 mm ²
630	B4045	2	For stranded Cu-conductors: KR D/KSD, KRT/KST 630 mm ²
630-800	B4053	2	For multi strand Cu-conductors: KRF/KSF (and stranded Cu conductors 800 mm ²): KR D/KSD/KRT/KST)
1000	B4056	2	For stranded Cu-conductors: KR D/KSD, KRT/KST

Hydraulic pumps

PS710

The PS710 is an electrically driven pump for crimping with advanced control and monitoring of crimping progress. A flexible system for a wide range of applications with high performance and reliability for professional use. The pump is suitable for cabling manufacturers as well as for fitters working in the field. The PS710 can be used for all types of crimping or cutting. The PS710 has a power source for all types of crimping.



Technical data:

- possibility to use different pressure ranges, 0 - 700 Bar
- oil flow at 20 bar: 0.6 litre/min (PS710D 1.2 litre/min)
- oil volume: 1.0 litre
- oil type: HYDREX MV 22 or similar
- crimps/battery charge: 120 crimps with Cu 150 mm²
- ambient temperature: - 15 to 40°C
- protection: IP54
- Li-ion battery 28,8V, 3,0 Ah
- Met CE requirements: Safety of machinery 2006/42/EC, Electromagnetic compatibility 2014/30/EU, Low Voltage Directive 2012/19/EU, ROHS 2014/35/EU, WEEE 2011/65/EU



PS710E with hydraulic hose and Ergocom handle together with the Analyzer software.



PS710E

For users working in the distribution network or industry.

Properties:

- small and light weight, which makes the product easy to use in every situation
- maximum performance, can be used both with Li-ion battery 28.8 V or 220V mains power
- LCD Display with keypad for full status information of pump to the fitter
- able to store and document crimps in the control system
- PC communication via USB
- to be used with crimp heads and cable cutters
- Elpress ergonomic handle ERGOCOM, with wireless communication can be selected for
- charger 230 VAC 50 Hz, 10.8-28.8 V, charging time 65 min



PS710E

Name	Net weight (kg)	Length mm	Width	Height
PS710E	12	370	170	280



PS710R

For users looking for a reliable standard product.

Properties:

- pump control without electronic control system, relay controlled
- easily equipped without data communication
- without battery
- to be used with crimp heads and cable cutters
- Elpress ergonomic handle ERGO, with wired communication, can be selected for



PS710R

Name	Net weight (kg)	Length mm	Width	Height
PS710R	12	370	170	280



PS710E251 and PS710E501*

Contains:

- pump E-version
- mains cable for EU
- hydraulic hose 2.4 m or 5.0 m with wireless communication ERGOCOM
- battery
- charger
- carrying strap

Name	Net weight (kg)	Length mm	Width	Height
PS710E251	24,5	370	170	280
PS710E501	26,0	370	170	280

* For countries outside EU contact Elpress



PS710R250 and PS710R500*

Contains:

- pump R version
- mains cable for EU
- hydraulic hose 2.4 or 5.0 m with wired communication ERGO
- carrying strap

Name	Net weight (kg)	Length mm	Width	Height
PS710R250	23,0	370	170	280
PS710R500	24,5	370	170	280

* For countries outside EU contact Elpress



Accessories for PS710x

Operating handle for operation of pump PS710. Ergonomically designed handle that reduces the load on the operator at the workstation. ERGOCOM is controlled via Bluetooth and ERGO is wired. Available in different designs depending on the length of the hydraulic hose.

Name	Net weight (kg)	Note	Pcs/ pack
HYD.SLANG KPL. 2,4M ERG PS710E	2,40	Hydraulic hose (2.4 m) for PS710E, with ERGO handle	1
HYD.SLANG KPL. 5M ERGO PS710E	3,90	Hydraulic hose (5 m) for PS710E, with ERGO handle	1
HYD.SLANG KPL.2,4M ERGO PS710R	2,43	Hydraulic hose (2.4 m) for PS710R, with ERGO handle	1
HYD.SLANG KPL. 5M ERGO PS710R	3,90	Hydraulic hose (5 m) for PS710R, with ERGO handle	1
HYD.SLANG KPL. 2,4M ERGOCOM	2,40	Hydraulic hose (2.4 m) for PS710R, with ERGOCOM handle (bluetooth)	1
HYD.SLANG KPL. 5M ERGOCOM	3,90	Hydraulic hose (5 m) for PS710R, with ERGOCOM handle (bluetooth)	1
FCU-PS710R	2,80	Foot pedal for PS710R	1
FCU-PS710D&E	2,80	Foot pedal for PS710D and PS710E	1
BÄRREM (strap) PS710	0,12	Carrying strap for all PS710 versions	1

Battery powered cable cutter



Cutting tool PCT54C.

PCT54C

Simple and safe electric cable cutter for cutting copper and aluminium cable.

Properties:

- electric cable cutter for cutting copper and aluminium cable
- not intended for cutting steel
- maximum cutting diameter 54 mm, which for the following cable types corresponds to:
 - 1 kV Cu type FKKJ 4 x 95 mm²
 - Al type AKKJ 4 x 240 mm²
 - Al type SE-N1XV 4G x 240 mm²
 - 12 kV Al type AXLJ 3 x 150 mm²
- tool performs a scissor motion when cutting that provides an optimal cut surface
- built-in fuse as a surge protector
- CE-marked
- comes with bag, 14.4V 3.0Ah Li-ion battery and charger

Max ϕ conductor	Name	Net weight (kg)	Length mm	Width	Height
54	PCT54C	8,60	450	120	105

Cable cutter up to \varnothing 50 mm



CE HKS50



Cable cutter for cutting cable up to approx. \varnothing 50 mm. Cutting tool for steel and Cu/Al cable with interchangeable blades. HKS50 is supplied with universal blade UFE1 for Al/Cu, FeAl line, flexible steel line and anchoring cables. Comes in a sturdy textile bag with instructions for use and cleaning tool for threads.

Properties:

- scissor-motion for the best cut surface on the cut cable
- single-handed operation facilitates installation
- reliable and proven ratchet function
- move blades easily and quickly by releasing two screws
- clearly marked usage area on the blades

Max \varnothing conductor	Name	Net weight (kg)	Length	Width	Height
50	HKS50	1,44	350	185	60



CE Blade for HKS50



Max \varnothing conductor	Name	Net weight (kg)
50	UFE2	0,130
50	UFE1	0,104
30	UFEB	0,111
50	UFE	0,104

Hydraulic cable cutters

A range of cable cutters covering virtually all needs for cutting power cables and OH-line wires.



CE



CE



HKL40 and KL40

KL2585

Hydraulic cable cutting head for copper and aluminum cable.

Properties:

- cuts up to 4 x 150 mm² Cu conductor and ϕ 85 mm Al, paper and plastic insulated conductors (there may be restrictions depending on the conductor's design and materials)
- cuts steel-reinforced cables, but not steel wire-reinforced cables
- used with foot pump P4000 or electrically powered pump P5710
- supplied in plywood box

mm ²	Max ϕ conductor	Name	Net weight (kg)	Length mm	Width	Height
630	85	KL2585	10,35	250	377	75

HKL40/KL40, HKL55/KL55, HKL85/KL85

A series of cable cutters covering almost all needs when cutting power cables and lines. The cutter heads (KL) are operated with one of Elpress' pumps, e.g. foot pump P4000 or pump P5710.

Max ϕ conductor	Name	Net weight (kg)	Length mm	Width	Height
40	HKL40	6,05	645	165	85
55	HKL55	4,13	560	140	55
85	HKL85	7,60	745	190	72
40	KL40	4,70	285	105	85
55	KL55	3,50	300	110	55
85	KL85	6,70	385	170	75

Technical Specifications

HKL40 / KL40 / HKL55 / KL55 / HKL85 / KL85

Hydraulic manual cutters	HKL40	HKL55	HKL85
Hydraulic cutting heads	KL40	KL55	KL85
Max. opening	ca ϕ 40	ϕ 55	ϕ 85
Max. cutting force, KN	88	43	55
Max. cutting capacity, examples.			
copper cable	ca ϕ 40	400(500)mm ²	630mm ²
Cu annealed solid conductor		ϕ 20	
Cu rod	ca ϕ 30		
Aluminium cable	ca ϕ 40	3x240+95mm ²	3x240+95mm ²
Al annealed solid conductor		ϕ 25	630(800mm ²)
ACSR	ϕ 40		
Al bar	ca ϕ 40		
Telephone cable		ϕ 55	
Steel wire (<180daN/mm ²)	ϕ 11		
Steel rod	ϕ 18		

Does not cut steel wire reinforced cable.



SYSTEM ELPRESS

SYSTEM ELPRESS

System Elpress symbolizes our **cornerstones**—safety and quality. In order to achieve a secure connection we offer **certified solutions** of the combination cable, terminal and tool.

For the installation to be accurate, the installer should undergo training in crimping technology at **Elpress Academy**.



For non-standard solutions you can **consult** us and let our own production and laboratory verify your solution. A preventive **service** maintenance of the tool is the base for the system to work.

Certification, Academy, Consulting and Service is System Elpress – your secure connection!

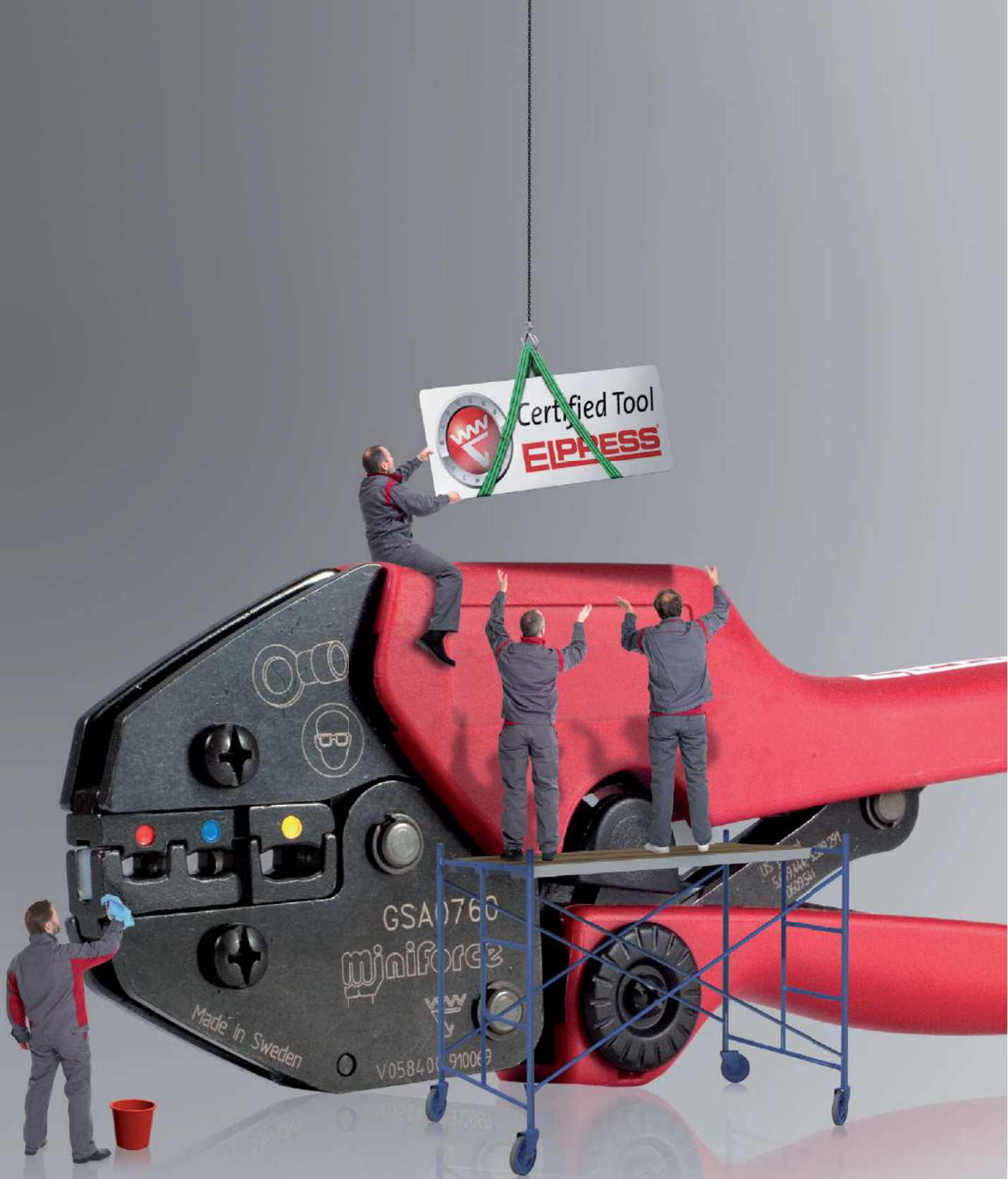

*We manufacture tested systems for electrical connectors
and their tools. You get a secure connection.*

SYSTEM ELPRESS CERTIFICATION

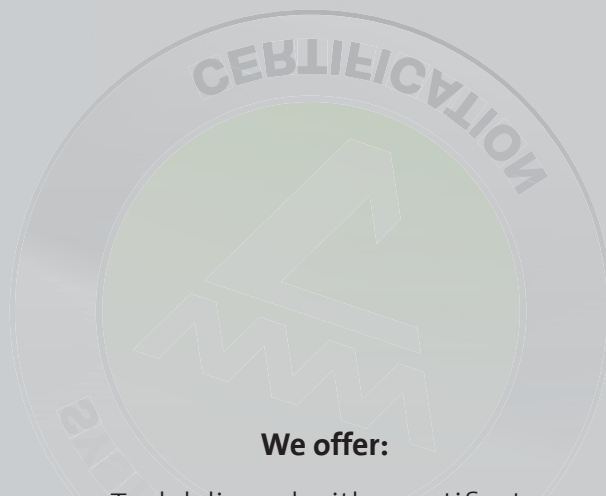

We offer:

Tool delivered with a certificate

Verified and tested combination of cable, terminal and tool

Certified solutions for customized product development

Product approval in accordance with UL, DNV and CSA

Third part quality and environment certification in accordance with ISO9001 and ISO14001



In order to achieve a secure connection we offer certified solutions of the combination cable, terminal and tool.

This is so that you as customer can feel secure when you use our system and be sure that a safe connection will be made when our products are used correctly.

FOR YOUR SAFETY

The System includes:

- Terminal, connector
- Crimping tool
- Correct cable
- Trained and skilled operator

The system is developed and tested in accordance with existing norms and standards, for example IEC.

Product development

- Customized solutions
- Specialized segment solutions
- Leading technology in our industry
- Innovative products





Quality & environment certified and approved according to

- ISO 14001
- ISO 9001
- DNV
- UL





*We have the necessary resources for you
to maintain the highest quality*

SYSTEM ELPRESS CONSULTING

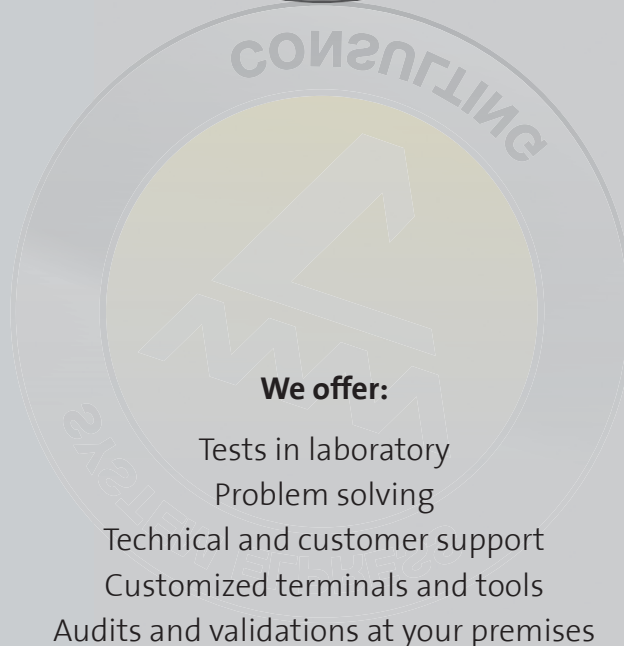

We offer:

- Tests in laboratory
- Problem solving
- Technical and customer support
- Customized terminals and tools
- Audits and validations at your premises



WHY CONSULT US?

We have been developing, manufacturing and marketing complete cable crimping systems for electrical connectors with more than 50 years of experience. We have therefore the best knowledge and equipment for your requirements and demands.

You will have access to:

- Our technical department that develops constructions according to your needs.
- Our production who can manufacture unique solutions.
- Our laboratory who can supply for example
 - Electrical tests
 - Mechanical tests
 - Corrosion- and environmental tests

Contact us and let us assist you.

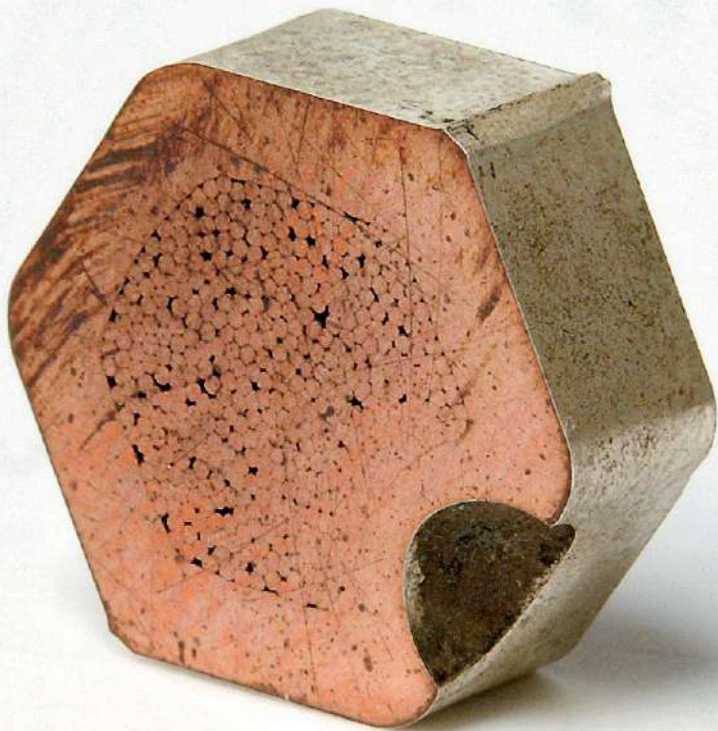



*A well educated personnel ensures the final quality of products and services.
Our Academy certificate is a Quality Assurance Document between you and your customer.*

SYSTEM ELPRESS ACADEMY



We focus on the following four areas:

- Utility sector and installers
- Transformer manufacturers
- Traction/Train manufacturers
- Wind Power manufacturers



WHO AND HOW DO WE EDUCATE?

Utility and installation personnel

General training for all staff. Provides a general knowledge of crimping in all areas;

- Terminals below 10 mm²
- Cu-connectors over 10 mm²
- Al-connectors from 16 mm²
- Cu-branching
- Bolt connections
- Deep earthing
- Standards and requirement
- Safety and maintenance
- Quality inspection

The program combines theory and practice and concludes with a written test. Course participants will receive certificate after completed education.

Possibility to customize the training so the content fits the needs of the company.

Transformer manufacturers

For operators who work daily in the production. The aim is to train personnel in the special conditions applying in the transformer manufacturing. The education concerns;

- Management of tools
- Calculations and preparation for crimping
- Work procedure
- Quality inspection
- Safety in use
- Preventive maintenance in daily production

The training consists of a theoretical and a practical part and ends with a written test. Course participants will receive certificate after completed education.

Education for all personnel such as operators, supervisors, designers and quality departments. Provides a thorough knowledge of calculations, tool selection and management, problems and solutions and quality assessment. Completed training gives a certificate.

A follow-up of the certificates is necessary



Each training has a level that suits everyone, such as operators, designers, supervisors and quality managers. In addition, there is the possibility to customize the training so that the content fits the needs of the company. You also decide whether the training should be company-based or held in Elpress's training facilities.

Train and vehicle manufacturers

Educate staff in the special demands and external conditions that apply in the manufacture of rail traffic. The education concerns;

- Management of tools
- Work procedure
- Elpress Dual-technology
- Crimp technique
- Quality inspection
- Safety in use
- Preventive maintenance in daily production

The training consists of a theoretical and a practical part and ends with a written test. Course participants will receive certificate after completed education.

Education for all personnel such as operators, supervisors, designers and quality departments. Provides a thorough knowledge of calculations, tool selection and management, problems and solutions and quality assessment. Completed training gives a certificate.

Wind Power manufacturers

Educate staff in the special demands and external conditions that apply in the manufacture of wind turbines. The education concerns;

- Management of tools
- Work procedure
- Elpress Dual-technology
- Crimp technique
- Quality inspection
- Safety in use
- Preventive maintenance in daily production

The training consists of a theoretical and a practical part and ends with a written test. Course participants will receive certificate after completed education.

Education for all personnel such as operators, supervisors, designers and quality departments. Provides a thorough knowledge of calculations, tool selection and management, problems and solutions and quality assessment. Completed training gives a certificate.

A follow-up of the certificates is necessary



*Preventive maintenance agreements
secure the quality of your connection*

SYSTEM ELPRESS SERVICE



We offer:

- Preventive maintenance agreements
- Calibration of certified tools
- Repairs/maintenance of tools
- Crimping systems for rent
- Sales of spare parts



WHAT IS THE BEST SOLUTION FOR YOU?

Preventive maintenance agreements

Our Service offers you a flexible solution for enhanced security, with rapid service and high availability:

- Planned and preventive maintenance guarantees high performance for your equipment.
- Regular service intervals minimize the risk of unforeseen stoppages by indicating any safety or functional defects and by recommending measures to avoid such problems.
- Regular service intervals are normally implemented every 12 months at a fixed price.
- The price is based on the service level solution and equipment.
- A certificate is issued after the equipment has complied with calibration requirements.
The maintenance can be performed at your premises.

Elpress Basic

Elpress Basic service agreement includes following points:

- General inspection of the tool
- Safety aspects in accordance with declaration of conformity
- Function test
- Checking of accessories, e.g. crimp dies etc.
- Issue of Certificate

The inspection follows Elpress final inspection and acceptance inspection requirements.

Elpress Advance

Elpress Advance service agreement includes following points:

- Elpress Basic + corrective maintenance

Includes the Calibration/certification and wear & tear repairs at a fixed price.

Calibration of certified tools

The calibration follows the same inspection points and requirements as Elpress Basic, but it is the customer's responsibility to send the tool for calibration.

Purchased a new product?

Send the Product registration form to Elpress and Elpress Basic is included for free the first year.



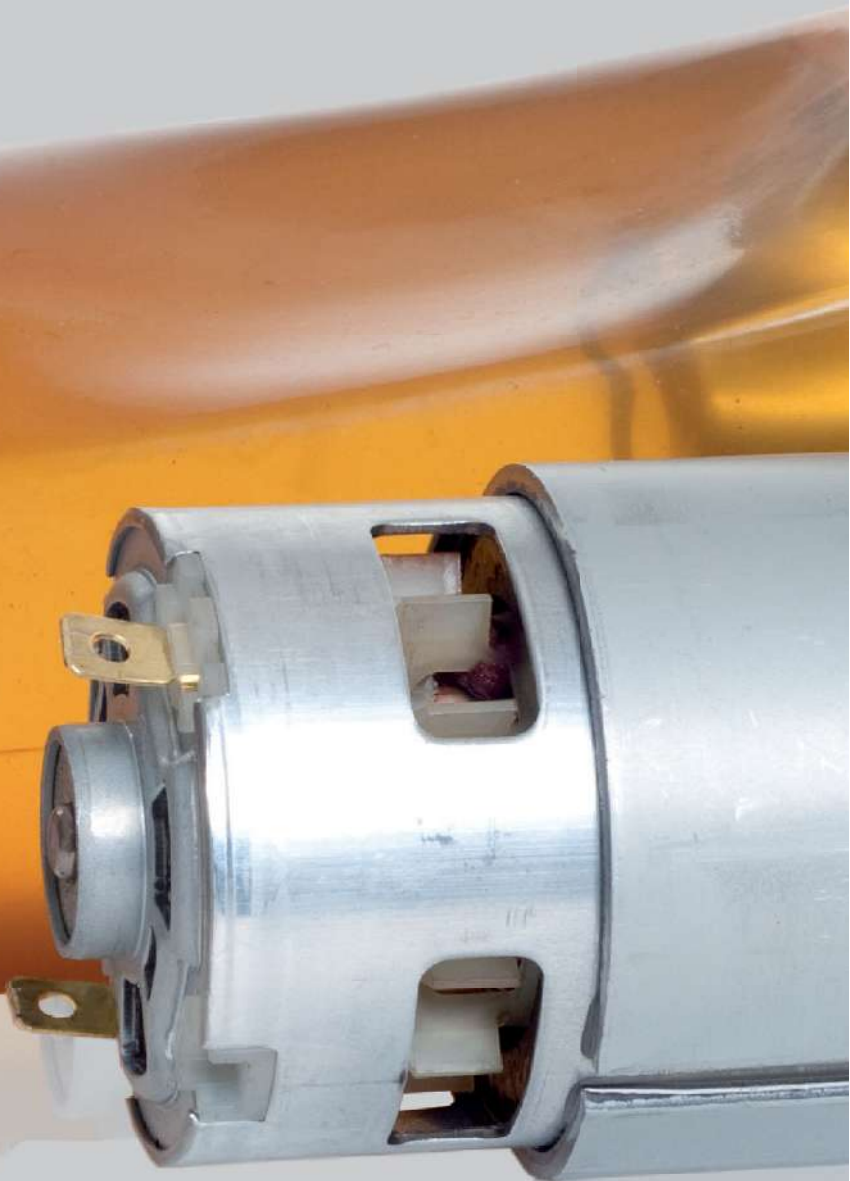

Table of content

Name	Page	Name	Page	Name	Page	Name	Page
13B11L	35	13R15DL	35	AKK150-16	19	AKS150L-120	18
13B13L	35	13R15DL-AL	36	AKK16-8	19	AKS150L-70	18
13B14,5L	35	13R15ML	35	AKK185-10	19	AKS150L-95	18
13B17L	35	13R15ML-AL	36	AKK185-12	19	AKS1625-1016	18
13B20L	35	13R17DL	35	AKK185-16	19	AKS185L-120	18
13B22L	35	13R17DL-AL	36	AKK240-10	19	AKS185L-150	18
13B25L	35	13R17ML	35	AKK240-12	19	AKS185L-95	18
13B27L	35	13R17ML-AL	36	AKK240-16	19	AKS240L-120	18
13B30L	35	13R19DL	35	AKK25-12	19	AKS240L-150	18
13B8	35	13R19DL-AL	36	AKK25-8	19	AKS240L-185	18
13B9L	35	13R19ML	35	AKK300-12	19	AKS30L-10	18
13CB14,5L	36	13R19ML-AL	36	AKK300-12SOLID	19	AKS30L-16	18
13CB17L	36	13R7,5DL-AL	36	AKK300-16	19	AKS35L-10	18
13CB20L	36	13R7,5ML-AL	36	AKK300-16SOLID	19	AKS35L-16	18
13CB22L	36	13R8DL	35	AKK300-20	19	AKS35L-25	18
13CB25L	36	13R8DL-AL	36	AKK300-20SOLID	19	AKS50L-10	18
13CB27L	36	13R8ML	35	AKK300B-12	19	AKS50L-16	18
13CB30L	36	13R8ML-AL	36	AKK300B-16	19	AKS50L-25	18
13P13D2	36	13R9DL	35	AKK35-12	19	AKS50L-35	18
13P13M2	36	13R9DL-AL	36	AKK35-8	19	AKS50L-50	18
13P14,5DL	35	13R9ML	35	AKK400-12	19	AKS70L-35	18
13P14,5ML	35	13R9ML-AL	36	AKK400-16	19	AKS70L-50	18
13P17DL	35	25R21DL	39	AKK400-20	19	AKS70L-70	18
13P17ML	35	25R21ML	39	AKK400B-12	19	AKS95L-35	18
13P20D2	36	25R24DL	39	AKK400B-16	19	AKS95L-50	18
13P20DL	35	25R24ML	39	AKK500A-1	19	AKS95L-70	18
13P20M2	36	25R26DL	39	AKK500A-16	19	B2525L	39
13P20ML	35	25R26ML	39	AKK500A-2	19	B2527L	39
13P22DL	35	25R30DL	39	AKK500A-20	19	B2530L	39
13P22ML	35	25R30ML	39	AKK500B-1	19	B2532L	39
13P25D2	36	25R33DL	39	AKK500B-16	19	B2538L	39
13P25DL	35	25R33ML	39	AKK500B-2	19	B2542L	39
13P25M2	36	25R39DL	39	AKK500B-20	19	B2550L	39
13P25ML	35	25R39ML	39	AKK50-10	19	B3530L	42
13P27DL	35	35R26DL	42	AKK50-12	19	B3532L	42
13P27ML	35	35R26ML	42	AKK50-8	19	B3538L	42
13P30DL	35	35R30DL	42	AKK630A-1	19	B3542L	42
13P30ML	35	35R30ML	42	AKK630A-2	19	B3550L	42
13P32D2	36	35R33DL	42	AKK70-10	19	B4040	44
13P32M2	36	35R33ML	42	AKK70-12	19	B4042	44
13R10DL-AL	36	35R39DL	42	AKK70-8	19	B4045	44
13R10ML-AL	36	35R39ML	42	AKK800-1	19	B4053	44
13R11DL	35	AKK1000-1	19	AKK800-2	19	B4056	44
13R11ML	35	AKK1000-2	19	AKK95-10	19	BÄRREM (strap) PS710	47
13R12DL-AL	36	AKK1200	19	AKK95-12	19	CUT10	16
13R12ML-AL	36	AKK120-10	19	AKK95-16	19	CUT16	16
13R13DL	35	AKK120-12	19	AKK95-8	19	CUT6	16
13R13DL-AL	36	AKK120-16	19	AKS120L-50	18	DKB0325	24
13R13ML	35	AKK150-10	19	AKS120L-70	18	DKB0760	24
13R13ML-AL	36	AKK150-12	19	AKS120L-95	18	DV350	41

Table of content

Name		Name	Page	Name	Page	Name	Page
ES2258	25	KRDIN120-10	17	KRDIN95-10	17	KRF240-10L-45GR	6
ES2258LB5	23	KRDIN120-12	17	KRDIN95-12	17	KRF240-10L-90GR	5
ES2258LB7	23	KRDIN120-16	17	KRDIN95-16	17	KRF240-10X2-24-26L	7
FCU-PS710D&E	47	KRDIN120-20	17	KRDIN95-8	17	KRF240-10X2-24-26L-90GR	8
FCU-PS710R	47	KRDIN150-10	17	KRF120-10L	4	KRF240-12L	4
GWB4099	24	KRDIN150-12	17	KRF120-10L-45GR	6	KRF240-12L-45GR	6
GWB4099C	24	KRDIN150-16	17	KRF120-10L-90GR	5	KRF240-12L-90GR	5
HKL40	50	KRDIN150-20	17	KRF120-10X2-24-26L	7	KRF240-12X2-40L	7
HKL55	50	KRDIN16-10	17	KRF120-12L	4	KRF240-12X2-40L-90GR	8
HKL85	50	KRDIN16-12	17	KRF120-12L-45GR	6	KRF240-12X2-44,5L	7
HKS50	49	KRDIN16-6	17	KRF120-12L-90GR	5	KRF240-12X2-44,5L-90GR	8
HYD.SLANG KPL. 2,4M ERG PS710E	47	KRDIN16-8	17	KRF120-12X2-40L	7	KRF240-16L	4
HYD.SLANG KPL. 2,4M ERGOCOM	47	KRDIN185-10	17	KRF120-12X2-44,5L	7	KRF240-8L	4
HYD.SLANG KPL. 5M ERGO PS710E	47	KRDIN185-12	17	KRF120-16L	4	KRF25-10L	4
HYD.SLANG KPL. 5M ERGO PS710R	47	KRDIN185-16	17	KRF120-16L-90GR	5	KRF25-10L-45GR	6
HYD.SLANG KPL. 5M ERGOCOM	47	KRDIN185-20	17	KRF120-8L	4	KRF25-10L-90GR	5
HYD.SLANG KPL.2,4M ERGO PS710R	47	KRDIN240-10	17	KRF150-00L	4	KRF25-12L	4
KB22	30	KRDIN240-12	17	KRF150-10L	4	KRF25-6L	4
KB22L	30	KRDIN240-16	17	KRF150-10L-45GR	6	KRF25-8L	4
KB25	30	KRDIN240-20	17	KRF150-10L-90GR	5	KRF25-8L-45GR	6
KL2585	50	KRDIN25-10	17	KRF150-10X2-24-26L	7	KRF25-8L-90GR	5
KL40	50	KRDIN25-12	17	KRF150-10X2-24-26L-90GR	8	KRF300-00L	4
KL55	50	KRDIN25-6	17	KRF150-12L	4	KRF300-10L	4
KL85	50	KRDIN25-8	17	KRF150-12L-45GR	6	KRF300-12L	4
KR0,75-3	14	KRDIN300-12	17	KRF150-12L-90GR	5	KRF300-12L-45GR	6
KR0,75-4	14	KRDIN300-16	17	KRF150-12X2-40L	7	KRF300-12L-90GR	5
KR1,5-3	14	KRDIN300-20	17	KRF150-12X2-40L-90GR	8	KRF300-12X2-40L	7
KR1,5-4	14	KRDIN35-10	17	KRF150-12X2-44,5L	7	KRF300-12X2-40L-90GR	8
KR1,5-5	14	KRDIN35-12	17	KRF150-12X2-44,5L-90GR	8	KRF300-12X2-44,5L	7
KR10-10	14	KRDIN35-6	17	KRF150-16L	4	KRF300-16L	4
KR10-12	14	KRDIN35-8	17	KRF150-16L-90GR	5	KRF300-16L-45GR	6
KR10-5	14	KRDIN400-12	17	KRF150-8L	4	KRF300-16L-90GR	5
KR10-6	14	KRDIN400-16	17	KRF16-10L	4	KRF300-20L	4
KR10-8	14	KRDIN400-20	17	KRF16-12L	4	KRF35-10L	4
KR2,5-3	14	KRDIN500-20	17	KRF16-6L	4	KRF35-10L-45GR	6
KR2,5-4	14	KRDIN50-10	17	KRF16-8L	4	KRF35-10L-90GR	5
KR2,5-5	14	KRDIN50-12	17	KRF185-00L	4	KRF35-12L	4
KR2,5-6	14	KRDIN50-16	17	KRF185-10L	4	KRF35-12L-45GR	6
KR4-4	14	KRDIN50-6	17	KRF185-10L-45GR	6	KRF35-12L-90GR	5
KR4-5	14	KRDIN50-8	17	KRF185-10L-90GR	5	KRF35-6L	4
KR4-6	14	KRDIN625-20	17	KRF185-10X2-24-26L	7	KRF35-8L	4
KR6-4	14	KRDIN6-5	17	KRF185-12L	4	KRF35-8L-45GR	6
KR6-5	14	KRDIN6-6	17	KRF185-12L-45GR	6	KRF35-8L-90GR	5
KR6-6	14	KRDIN6-8	17	KRF185-12L-90GR	5	KRF400-00L	4
KR6-8	14	KRDIN70-10	17	KRF185-12X2-40L	7	KRF400-10L	4
KRDIN1000-20	17	KRDIN70-12	17	KRF185-12X2-44,5L	7	KRF400-12L	4
KRDIN10-10	17	KRDIN70-16	17	KRF185-16L	4	KRF400-12L-45GR	6
KRDIN10-5	17	KRDIN70-6	17	KRF185-20L	4	KRF400-12L-90GR	5
KRDIN10-6	17	KRDIN70-8	17	KRF240-00L	4	KRF400-12X2-40L	7
KRDIN10-8	17	KRDIN800-20	17	KRF240-10L	4	KRF400-12X2-44,5L	7

Table of content

Name	Page	Name	Page	Name	Page	Name	Page
KRF400-12X2-44,5L-90GR	8	KRF95-8L-90GR	5	KS630P	16	KSF400L	9
KRF400-16L	4	KRFS120-10	15	KS70P	16	KSF500-120L	10
KRF400-16L-90GR	5	KRFS120-12	15	KS70PL	11	KSF500-150L	10
KRF400-20L	4	KRFS120-6	15	KS95P	16	KSF500-185L	10
KRF500-00L	4	KRFS120-8	15	KS95PL	11	KSF500-240L	10
KRF500-12L	4	KRFS150-10	15	KSF120-35L	10	KSF500-300L	10
KRF500-12X2-40L	7	KRFS150-12	15	KSF120-50L	10	KSF500-400L	10
KRF500-12X2-44,5L	7	KRFS150-6	15	KSF120-70L	10	KSF500-95L	10
KRF500-12X2-44,5L-90GR	8	KRFS150-8	15	KSF120-95L	10	KSF500L	9
KRF500-16L	4	KRFS185-10	15	KSF120L	9	KSF50-25L	10
KRF500-20L	4	KRFS185-12	15	KSF150-120L	10	KSF50-35L	10
KRF50-10L	4	KRFS240A-10	15	KSF150-35L	10	KSF50L	9
KRF50-10L-45GR	6	KRFS240A-12	15	KSF150-50L	10	KSF630-240L	10
KRF50-10L-90GR	5	KRFS240A-16	15	KSF150-70L	10	KSF630-300L	10
KRF50-10X2-24-26L	7	KRFS300A-10	15	KSF150-95L	10	KSF630-400L	10
KRF50-12L	4	KRFS300A-12	15	KSF150L	9	KSF630-500L	10
KRF50-12L-45GR	6	KRFS300A-16	15	KSF16L	9	KSF630L	9
KRF50-12L-90GR	5	KRFS400A-12	15	KSF185-120L	10	KSF70-25L	10
KRF50-12X2-44,5L	7	KRFS400A-16	15	KSF185-150L	10	KSF70-35L	10
KRF50-16L	4	KRFS50-10	15	KSF185-35L	10	KSF70-50L	10
KRF50-8L	4	KRFS50-6	15	KSF185-50L	10	KSF70L	9
KRF50-8L-45GR	6	KRFS50-8	15	KSF185-70L	10	KSF95-25L	10
KRF50-8L-90GR	5	KRFS70-10	15	KSF185-95L	10	KSF95-35L	10
KRF630-12X2-44,5L	7	KRFS70-6	15	KSF185L	9	KSF95-50L	10
KRF630-12X2-44,5L-90GR	8	KRFS70-8	15	KSF240-120L	10	KSF95-70L	10
KRF630-20L	4	KRFS95-10	15	KSF240-150L	10	KSF95L	9
KRF70-10L	4	KRFS95-12	15	KSF240-185L	10	KTSF120	13
KRF70-10L-45GR	6	KRFS95-6	15	KSF240-35L	10	KTSF120-110GR	13
KRF70-10L-90GR	5	KRFS95-8	15	KSF240-50L	10	KTSF120-150	12
KRF70-10X2-24-26L	7	KS0,75	14	KSF240-70L	10	KTSF120-185	12
KRF70-10X2-24-26L-90GR	8	KS1,5	14	KSF240-95L	10	KTSF150	13
KRF70-12L	4	KS10	14	KSF240L	9	KTSF150-110GR	13
KRF70-12L-45GR	6	KS120P	16	KSF25L	9	KTSF150-50	12
KRF70-12L-90GR	5	KS120PL	11	KSF300-120L	10	KTSF150-95	12
KRF70-12X2-44,5L	7	KS150P	16	KSF300-150L	10	KTSF185	13
KRF70-16L	4	KS150PL	11	KSF300-185L	10	KTSF185-110GR	13
KRF70-8L	4	KS185P	16	KSF300-240L	10	KTSF185-150	12
KRF70-8L-90GR	5	KS185PL	11	KSF300-70L	10	KTSF185-35	12
KRF95-10L	4	KS2,5	14	KSF300-95L	10	KTSF185-50	12
KRF95-10L-45GR	6	KS240P	16	KSF300L	9	KTSF185-95	12
KRF95-10L-90GR	5	KS240PL	11	KSF35-16L	10	KTSF240	13
KRF95-10X2-24-26L	7	KS25P	16	KSF35-25L	10	KTSF240-110GR	13
KRF95-12L	4	KS300P	16	KSF35L	9	KTSF240-120	12
KRF95-12L-45GR	6	KS35P	16	KSF400-120L	10	KTSF240-150	12
KRF95-12L-90GR	5	KS4	14	KSF400-150L	10	KTSF240-185	12
KRF95-12X2-40L	7	KS400P	16	KSF400-185L	10	KTSF240-35	12
KRF95-12X2-44,5L	7	KS500P	16	KSF400-240L	10	KTSF240-400	12
KRF95-16L	4	KS50P	16	KSF400-300L	10	KTSF240-50	12
KRF95-16L-90GR	5	KS50PL	11	KSF400-35L	10	KTSF240-95	12
KRF95-8L	4	KS6	14	KSF400-95L	10	KTSF25-50	12

Table of content

Name	Page	Name	Page
KTSF300	13	MB9	27
KTSF300-110GR	13	PCT54C	48
KTSF300-150	12	PS710E	46
KTSF35	13	PS710E251	47
KTSF35-110GR	13	PS710E501	47
KTSF400	13	PS710R	46
KTSF400-110GR	13	PS710R250	47
KTSF400-150	12	PS710R500	47
KTSF400-185	12	PVL130L	26
KTSF400-240	12	PVL350	27
KTSF400-300	12	PVX1300	33
KTSF400-35	12	PVX1300-ADV	33
KTSF400-50	12	PVX1300-ADV	34
KTSF400-95	12	PVX1300C2	34
KTSF50	13	PVX1300C2DB	34
KTSF500	13	PVX1300DB	33
KTSF500-150	12	PVX1300DB-ADV	33
KTSF500-185	12	PVX1300DB-ADV	34
KTSF500-240	12	PVX611	29
KTSF500-300	12	PVX611DB	29
KTSF500-35	12	T2258	25
KTSF500-400	12	TB11-14,5	30
KTSF500-50	12	TB11L	30
KTSF500-95	12	TB13L	30
KTSF50-110GR	13	TB14,5L	30
KTSF50-150	12	TB17L	30
KTSF630	13	TB20L	30
KTSF70	13	TB7-20	30
KTSF70-110GR	13	TB8-17	30
KTSF70-120	12	TB9-13	30
KTSF70-150	12	TBKA9-11,5	31
KTSF70-240	12	UFE	49
KTSF70-95	12	UFE1	49
KTSF95	13	UFE2	49
KTSF95-110GR	13	UFEB	49
KTSF95-150	12	V1300	32
KTSF95-240	12	V1300A	32
KTSF95-35	12	V1300C2	33
KTSF95-50	12	V1300L	32
L1300 CU-ALU	37	V1470	43
LB5	26	V250	38
LB7	26	V250	38
LV1300L	37	V600	28
LV250L	40	V611	28
MB11	27	W60D	44
MB13	27	W60M	44
MB14,5	27	W70D	44
MB17	27	W70M	44
MB4016	27		
MB8	27		

Europe



USA



Asia



Head office and production

Elpress AB, Kramfors Sweden

Subsidiaries and sales offices

- Elpress AS, Silkeborg Denmark
- Elpress GmbH, Viersen Germany
- Elpress China, Beijing China
- Elpress Inc, Chicago USA
- Elpress India, India New Delhi



Service partners

- Hydraulikkteknikk, Hagan (Oslo) Norway
- Enkom, Vasa Finland
- Hamburger Hochdruck Hydraulik, Hamburg Germany
- E-Tech components, Skelmersdale England
- Precision Hydraulics, Portland USA



Distributors och partners

- Unitronic GmbH, Dusseldorf Germany
- Enkom-Active Oy, Helsingby Finland
- JF Knudtzen AS, Nesbru Norway
- Jobarco, Br BenthuiZEN Netherlands
- ACTE Sp. Z o.o., Warsaw Poland
- E-tech Components, West Lancashire UK

