

Shearbolt terminals for low and medium voltage

Shearbolt terminals.....	2
Shearbolt connectors 10 - 240 mm ² (pre-assembled screw).....	3
Shearbolt connectors 10 - 630 mm ² (reversible screw).....	3
Filler piece.....	4
Shearbolt terminals 10 - 630 mm ² (pre-assembled screw).....	4
Shearbolt terminals 10 - 630 mm ² (reversible screw).....	5
Screw branch clamps.....	5
Counterhold tool.....	5

Shearbolt terminals

Shearbolt terminals up to 36 kV

Elpress shearbolt terminals are available as through connectors and terminals for:

- stranded and solid Al and Cu cables
- round cross section 10 to 630 mm²
- sector cross section 16 to 240 mm²



SL240N-12

The screws used are made of brass, that has the advantage of providing a lower friction compared to aluminium or steel screws. This makes it easier for the user to perform the installation. Installation tools can be a socket wrench or an impact wrench with torque force >100 Nm. We recommend that the fitter uses a counterhold tool to secure the shearbolt terminal more easily when tightening the screws.

Handles multiple area steps

The advantages of shearbolt terminals are that installation can be done easily without any heavy special tools and that they can manage several area steps in the same through connector/terminal, for example 10-50 mm². The user gets a reduced range of products and a flexible solution.

Shearbolt terminals are made of hardened aluminium with an alloy that allows both copper and aluminium cable to be joined, while preventing the occurrence of galvanic corrosion. To reduce the number of terminal variants, screw terminals are supplied with reduction washers that allow the use of two different bolt sizes.

Washers are always needed for connecting terminals with screw joints to busbars.



Use a socket wrench to tighten the screws. It is also possible to use an impact wrench.

SC50R50S

On the SC50R50S through connector, the screws are threaded into the sleeve and can handle all their cable areas on one thread length. SC50R50S is also suitable as a screen connector for 10-35 mm² Cu/Al.



Through connector SC50R50S with pre-assembled screws.

Labelling

Elpress marking of shearbolt terminals shows logo, product name, cable area (for stranded and solid conductors) and shearbolt installation order. The terminal palm is marked with screw size M-thread for bolted joints.

Cat. no. SL70R70S-10-12

SL = Shearbolt terminal
70R = max 70 mm² round conductor
70S = max 70 mm² sector conductor
10-12 = screw size 10 and 12 M thread

Cat. no. SC50R50S

SC = Shearbolt connector
50R = max 50 mm² round conductor
50S = max 50 mm² sector conductor

Screw and washer

The following apply for bright galvanized type nuts and screws, with strength class 8.8, used for connecting terminals with Cu and Al palms:

- Always use a torque wrench to be certain the right torque is achieved. Make sure it is calibrated at regular intervals according to the supplier's instructions.
- Use the recommended torque according to the screw manufacturer's instructions.
- Always use a hard flat washer to reduce friction against the connection surface and the edge pressure, hardness min HB200.
- Install as illustrated.

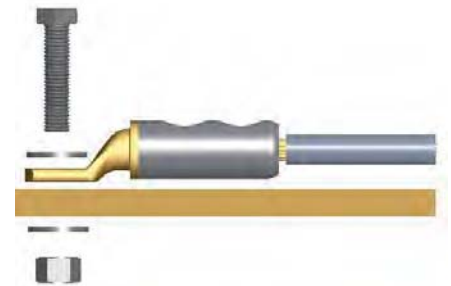

Tightening torque

Recommended tightening torque for wet lubricated screws and nuts of bright galvanized zinc type with strength class 8.8 and coarse threaded (normal thread), used with corresponding washer for connection of terminals with Cu- and Al palm. See table in Chapter 12.

Shearbolt connectors 10 - 240 mm² (pre-assembled screw)

Properties:

- screw material: brass, for minimum friction
- partition
- pre-assembled shear-off screws for easy handling
- voltage range: 1 kV
- meets the requirements of standard IEC 61238-1
- PEN is a filler piece for use when connecting the cable's copper screen

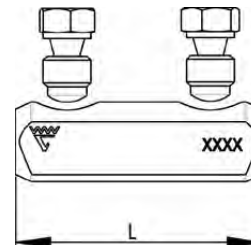
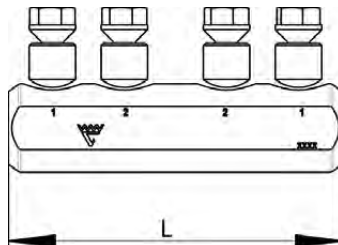

Through connector SC50R50S with threaded screws.

Cable type round mm ²	Cable type sector mm ²	Name	Screen conductor	Screen conductor (with filling piece)	d	D	L	Pcs/ pack
10-50	16-50	SC50R50S	10-35		10,7	17,3	62	10
35-95	50-95	SC95N	57-95	16-50 (SC95N/PEN)	16,8	23,0	69	1
70-150	70-150	SC150N	120-146	21-95 (SC150N/PEN)	19,5	23,0	80	1
95-240	120-240	SC240N		29-146 (SC240/PEN)	25,0	33,1	144	1

s = strip length

Shearbolt connectors 10 - 630 mm² (reversible screw)

Properties:

- screw material: brass, for minimum friction
- partition
- reversible shear-off screws
- voltage range: 1 kV to 36 kV
- meets the requirements of standard IEC 61238-1
- PEN is a filler piece for use when connecting the cable's copper screen

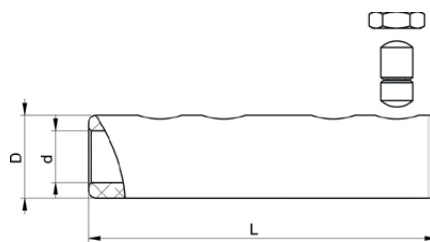

Cable type round mm ²	Cable type sector mm ²	Name	Screen conductor	Screen conductor (with filling piece)	d	D	L	s	Pcs/ pack
50-95	50-95	SC95R95S	70-95	16-57 (SC95N/PEN)	16,0	27,0	114	58	1
95-150	95-120	SC150R95S	70-95		16,0	27,0	114	58	1
185-240	120-185	SC240R185S			20,0	33,5	134	64	1
300-400	240	SC400R240S			25,8	41,5	175	87	1
500-630		SC630R			33,0	49,0	210	106	1

s = strip length

Filler piece

To splice the copper screen around the conductors, a filler piece is required that is placed between the screw and the screen. To select the correct filler piece, see table. Requires 2 filler pieces per splice.



SC95N PEN

Name	Screen conductor	Note
SC95N/PEN	16-57*	*16-50 mm ² (SC95N) / 16-57 mm ² (SC95R95S)
SC150N/PEN	21-95	
SC240/PEN	29-146	

Shearbolt terminals 10 - 630 mm² (pre-assembled screw)

Properties:

- screw material: brass for minimum friction
- pre-assembled shear-off screws for easy handling
- voltage range: 1 kV for SL50N-10-12, SL95N-10-12 and SL240N-10-12, 1-36 kV for the others
- meets the requirements of standard IEC 61238-1
- the terminals are of the bimetallic type

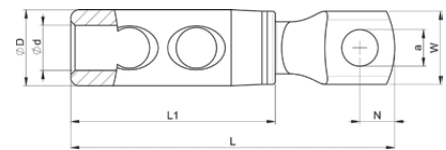
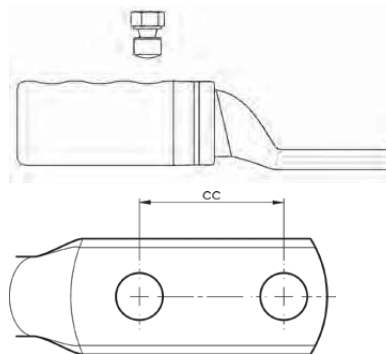

Cable type round mm ²	Cable type sector mm ²	Name	Screen conductor	Screen conductor (with filling piece)	Screw	W mm	d	D	N	cc	a	L	L1	t	s
10-50	10-50	SL50N-10-12	10-35		M10, M12	25,5	12	20/17,3	12,5	13	87	44	5,9	32	
35-95	35-95	SL95N-10-12	57-95	16-50 (SC95N/PEN)	M12, M10	27,3	16	17/23	12,5	13	96	52,5	4,7	56	
120-240	120-240	SL240N-10-12		29-146 (SC240/PEN)	M12, M10	31,5	25	38/33,1	15	13	144,5	86	7,6	76	
185-240		SL240R-12-16			M12, M16	30	20	33,5	15	12	134	79	7,9	75	
185-240		SL240R-12X2-40			M12x2	31,5	20,0	33,5	15	40	12	174	79	7,9	75
300-400		SL400R-12X2-40			M12x2	42	25,8	41,5	15	40	12	210	103	9,6	99
630		SL630B-12X2-40			M12x2	55	33,0	49,0	17	40	12	218	115	11,7	108

t = palm thickness, s = strip length

Shearbolt terminals 10 - 630 mm² (reversible screw)

Properties:

- screw material: brass for minimum friction
- reversible shear-off screws
- voltage range: 1 kV to 36 kV
- meets the requirements of standard IEC 61238-1
- the terminals are of the bimetallic type for best functionality



Shearbolt terminal

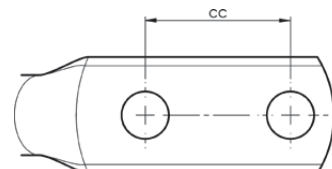
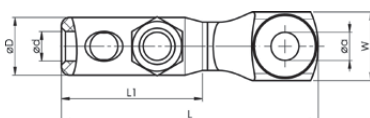
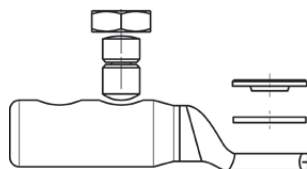

Cable type round mm ²	Cable type sector mm ²	Name	Screen conductor	Screw	W mm	d	D	N	cc	a	L	L1
10-70	25-70	SL70R70S-10-12	10-57	M10, M12	25,5	11,0	21	12,5	12	97	59	
95-150	95	SL150R95S-10-12	70-95	M10, M12	26	16	27	12,5	12	116	75,5	
95-150	95	SL150R95S-12X2-40	70-95	M12x2	30,5	16	27	15	40	12	172	75,5
185-240	120-185	SL240R185S-12-16		M12, M16	31,5	20	33,5	15		16	134	78,5
300-400	240	SL400R240S-16		M16	41,5	25,8	41,5	21		16	182	103
300-400	240	SL400R240S-20		M20	41,5	25,8	41,5	21		20	182	103
300-400	240	SL400R240S-00			41,5	33	49				187	103
500-630		SL500B-630B-12X2-40		M12x2	55	33	49	12	40	12	218	115
500-630		SL630R-1			55	33	49				243	129
500-630		SL630R-16		M16	55	33	49	30		16	241,5	129
500-630		SL630R-14		M14	55	33	49	30		14	243	129
500-630		SL630R-12X2-40		M12x2	55	33	49	15	40	12	243	129

t = palm thickness, s = strip length

Screw branch clamps

Screw clamps for earthing applications. Enables branching of reinforcing bars with a stranded earth line in Cu or Fe.



Name	Pcs/pack
SBC50	1

Counterhold tool

Counterhold tool for stable and safe installation of shearbolt terminals. Tools are made from durable material and are easily adjustable for terminals up to 400 mm².



ISL2201

Name	Pcs/pack
ISL2201	1