



# E1U

## CAPTIVE COMPONENT GLAND®

for Multi Armoured Cable

### Features and Benefits

- For indoor and outdoor use.
- Two piece handling, no loose parts.
- Freely rotating captive cone and inspectible cone ring, providing an armour clamp and earth bond without twisting the armour wire. Patented disconnect system for armour clamp inspection.
- Factory fitted captive elastomeric inner seal for Built in Safety™.
- Seals on both the inner and outer sheath of the cable to IP65/66/68.
- Precision manufactured from high-quality brass (nickel plated) available in aluminium or stainless steel 316/316L on request.
- Complete with thread sealing gasket and with heavy duty locknut.



### Technical Data

Type:	E1U
Gland Material:	Brass (Nickel Plated), BS 2874, EN 12164, Aluminium ASTM BS221, Stainless Steel 316/316L
Seal Material:	Thermoset Elastomer or Silicone on request
Cable Type:	Steel Wire Armour, Aluminium Wire Armour, Braided and Steel Tape Armour
Armour Clamping:	Rotating Captive Cone and Inspectible Cone Ring
Sealing Area:	Inner Sheath and Outer Sheath
Optional Accessories:	Adaptor, Reducer, Earth Tag, Locknut, Serrated Washer and Shroud

### Standards and Certifications

Mechanical Properties:	Impact Category 8 Anchorage Type D
Electrical Properties:	Category A (no earth tag) Category B (with earth tag)
Continuous Operating Temp:	-65°C to +120°C
Conformance:	Standard: Certificate:
Design Standards	BS 6121:Part 1 CML 14CA364 EN 50262 CML 14CA364 IEC/BS EN 62444 CML 14CA364 SANS 62444 MASC 11-303 SANS 1213 MASC 18-2047, SANS 2109/4596 IP66/68 100m - Parallel IEC 60529 CML 15Y728, MASC 11-263 IP65 - Tapered IEC 60529
Marine ABS	IEC 60529, IEC 62444 ABS 20-SG1952694-PDA
DNV-GL	IEC 60529, BS 6121, IEC 62444 DNV-GL TAE000000Z
EMC Compatible	EN 55011:2009 + A1:2010, EN 55022:2010 SGS EMC197708/1
London Underground Approval	BS EN 62444 LU 3043

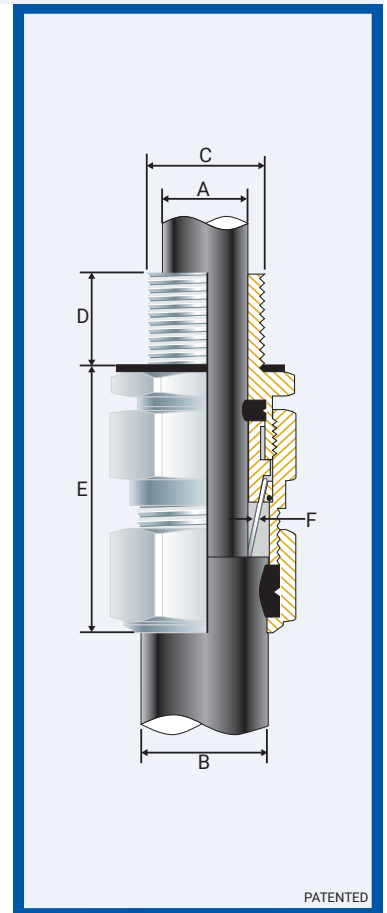

### Installation Standards

- AS/NZS 3000
- BS 7671
- IEC 60364-5-54
- BS 6121-5
- BS 7430
- SANS 0142

Product Code	Gland Size Reference	Metric Entry Thread		NPT Entry Thread		Cable Detail				Max Length 'E'	Armour Dia		Hexagonal Detail		Install Torque Value Nm
		'C'	Min 'D'	'C'	Min 'D'	Min 'A'	Max 'A'	Min 'B'	Max 'B'		Min 'F'	Max 'F'	Max 'Flats'	Max 'Crns'	
050800-16	00-16ss	M16x1.5	10	-	-	3.0	8.5	8.0	13.5	60.0	0.20	0.90	♦24.0	♦27.0	21.0
050800	00-20ss	M20x1.5	10	½/¾	15	3.0	8.5	8.0	13.5	60.0	0.20	0.90	♦24.0	♦27.0	21.0
0508-0	0-20s	M20x1.5	10	½/¾	15	7.0	12.0	11.5	16.0	60.0	0.20	1.25	♦24.0	♦27.0	21.0
050801	1-20	M20x1.5	10	½/¾	15	9.0	15.0	14.5	20.5	67.0	0.20	1.25	27.0	30.0	21.0
050822	2s-25s	M25x1.5	10	¾/1	15/19	11.0	17.5	16.0	24.5	76.0	0.20	1.60	35.0	39.0	30.0
050802	2-25	M25x1.5	10	¾/1	15/19	14.0	20.0	20.5	26.5	76.0	0.20	1.60	35.0	39.0	30.0
050833	3s-32s	M32x1.5	10	1/1¼	19	15.0	22.0	23.0	30.5	83.0	0.20	2.00	42.0	47.0	42.0
050803	3-32	M32x1.5	10	1/1¼	19	19.0	26.5	26.5	33.5	83.0	0.20	2.00	42.0	47.0	42.0
050844	4s-40s	M40x1.5	15	1¼/1½	19/21	22.0	31.5	30.0	39.5	95.0	0.30	2.00	52.0	59.0	52.0
050804	4-40	M40x1.5	15	1¼/1½	19/21	26.0	34.0	33.0	42.5	95.0	0.30	2.00	52.0	59.0	52.0
050855	5s-50s	M50x1.5	15	1½/2	21	29.0	38.0	34.0	47.5	117.0	0.40	2.50	65.0	73.0	57.0
050805	5-50	M50x1.5	15	1½/2	21	34.0	44.5	42.5	52.5	117.0	0.40	2.50	65.0	73.0	57.0
050866	6s-63s	M63x1.5	15	2/2½	21/30	38.0	50.0	45.5	60.5	133.0	0.40	2.50	80.0	90.0	66.0
050806	6-63	M63x1.5	15	2/2½	21/30	44.0	56.5	52.5	65.5	133.0	0.40	2.50	80.0	90.0	66.0
050877	7s-75s	M75x1.5	15	2½/3	30/32	50.0	62.0	57.0	72.5	152.0	0.40	3.15	96.0	108.0	72.0
050807	7-75	M75x1.5	15	2½/3	30/32	56.0	67.5	65.5	78.0	152.0	0.40	3.15	96.0	108.0	72.0
050808	8-80	M80x2.0	20	3	32	59.0	69.0	65.0	77.5	159.0	2.50	3.15	96.0	108.0	80.0
050899	9s-90s	M90x2.0	20	3/3½	32/33	66.0	75.0	73.0	86.5	159.0	3.00	3.50	111.0	125.0	89.0
050809	9-90	M90x2.0	20	3/3½	32/33	74.0	81.5	82.0	91.0	159.0	3.00	3.50	111.0	125.0	89.0
050810	10-100	M100x2.0	20	3½/4	33/34	81.0	91.0	90.0	100.0	160.0	3.00	3.50	125.0	141.0	98.0

All dimensions except NPT are in mm.

♦ When manufactured in Aluminium, Hex will be 27 Across Flats and 30 Across Corners.

CCG reserves the right to make alterations to the technical data, dimensions, designs and products available without notice. The illustrations cannot be considered binding. Please contact CCG for assistance.

E1U-EMC100321E

All Enquiries: tel: +44 (0)1744 762 929 | email: sales@etechcomponents.com | web: www.etechcomponents.com

2021 © CCG CABLE TERMINATIONS (PTY) LTD

### E1U CAPTIVE COMPONENT GLAND®

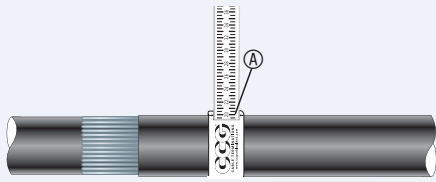

1. For accurate sizing, use a CCG Dimension Tape (A) on the inner and outer cable sheath.

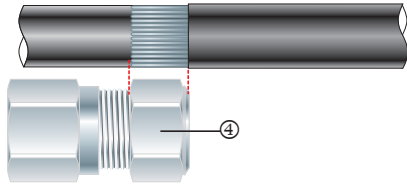

2. Cut back the cable outer sheath to expose the armour to a length not more than the outer nut (4).

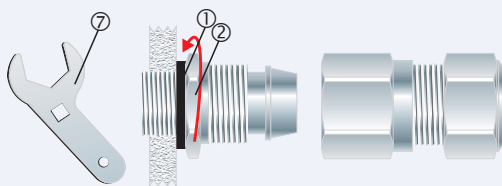

3. To maintain IP66/68 ensure the gasket (1) is in place. Screw the inner (2) into the apparatus. Tighten the inner (2), to installation torque using a CCG Spanner (7).

Alternative installation through an unthreaded entry.

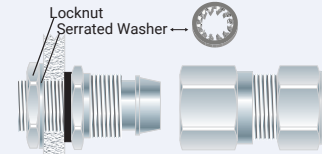

If the apparatus is untapped use a locknut.

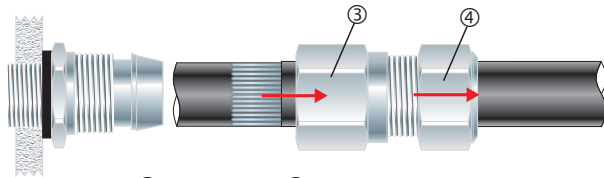

4. Pass the outer nut (4) and the body (3) over the cable.

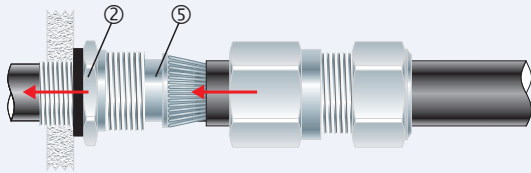

5. Pass cable end through the inner (2) and splay the armour wires over the cone (5).

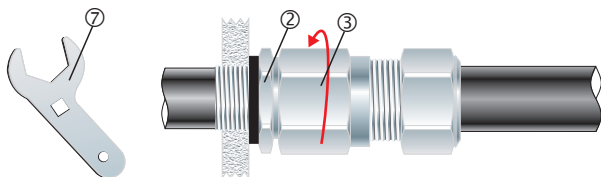

6. Tighten the body (3) onto the inner (2) until hand tight, then tighten with a CCG Spanner (7) with  $\frac{3}{4}$  turn to lock the armour between the cone (5) and the cone ring (6).

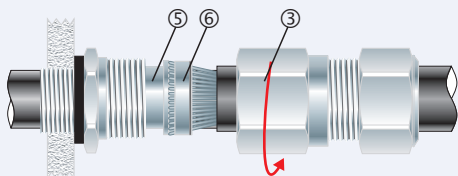

7. Unscrew the body (3). Check that the armour has locked between the cone (5) and the cone ring (6). (O-Ring on the cone ring (6) is sacrificial)

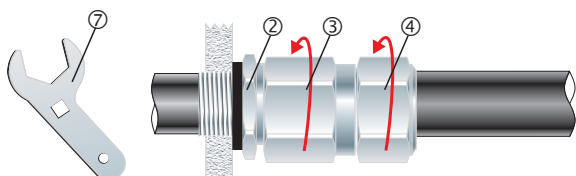

8. Tighten the body (3) onto the inner (2) to the installation torque using a CCG Spanner (7). Tighten the outer nut (4) to produce a moisture proof seal by turning until the seal makes contact with the outer sheath of cable and then turn one full turn.