

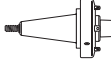
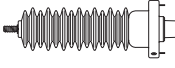

# CONNECTING POSSIBILITIES

## BUSHINGS / ACCESSORIES / CONNECTOR

**Equipment interface** 

**(K)180AR-1(-G),-2 & -3(-G)**  
Equipment bushing 

**180A-24P-O**  
In-air bushing 

**(K)150S** 

**(K)200T**  
Tee connector 

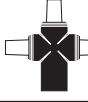
**(K)200X**  
Cross connector 

**(K)150DP**  
Dead-end plug 

**(K)151SOP**  
Stand-off plug 

**250GP**  
Earthing plug 

**(K)400RTPA**  
Reducing tap plug 

**(K)676RTPA**  
Reducing tap plug 

## CONNECTION

dead-ending of equipment

two cables to equipment

three cables to equipment

one line to equipment

one cable to equipment

in-line junction

in-line junction + tap-off

in-line junction + 2 tap-offs

cable isolation

cable earthing

tap-off 630/250 A

tap-off 1250/250 A

## CONNECTORS / ACCESSORIES

**(K)150DR**  
Dead-end receptacle 

**(K)200T**  
Tee connector 

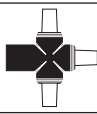
**(K)200X**  
Cross connector 

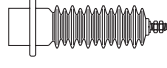
**PITO-E**  
Plug-in termination 

**(K)200SR**  
Straight connector 

**(K)200LR**  
Elbow connector 

**156SA**  
Surge arrester 

**(K)200SR**  
Straight connector 

**(K)200LR**  
Elbow connector 

**(K)200T**  
Tee connector 

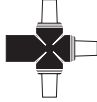
**(K)200X**  
Cross connector 

**(K)150DR**  
Dead-end receptacle 

**(K)151SP**  
Straight plug 

disconnectable joint

in-line junction + tap-off

in-line junction + 2 tap-offs

cable isolation

# POSSIBLE ARRANGEMENTS

## BAIL SADDLE

Different cable arrangements are possible by using the BAIL SADDLE 200X/T.

The standard bails that are delivered in the kit with the 200LR elbow connectors, 200SR straight connector, 156SA surge arrester... are fitting in the tabs of the bail saddle. No extra or special bails are required.

## APPLICATION

For use with 150S in-line junction, 200T separable tee connector and 200X separable cross connector.

## ORDERING INSTRUCTIONS

Bail saddle 200X/T  
Item nr 25690

### 200LR+150S+200LR

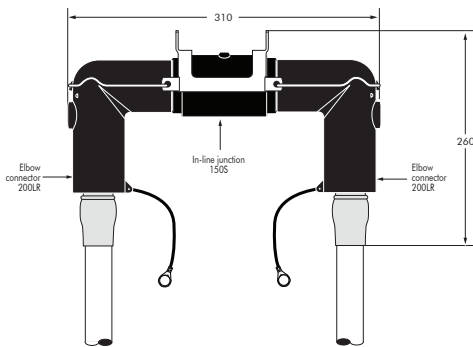

### 200SR+150S+200SR

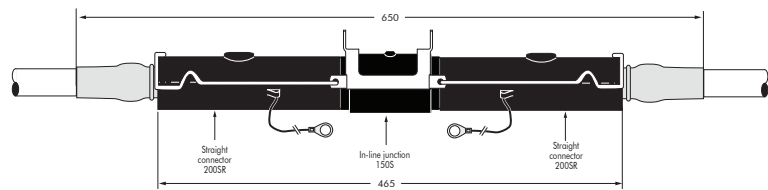

### 200LR+200T+156SA

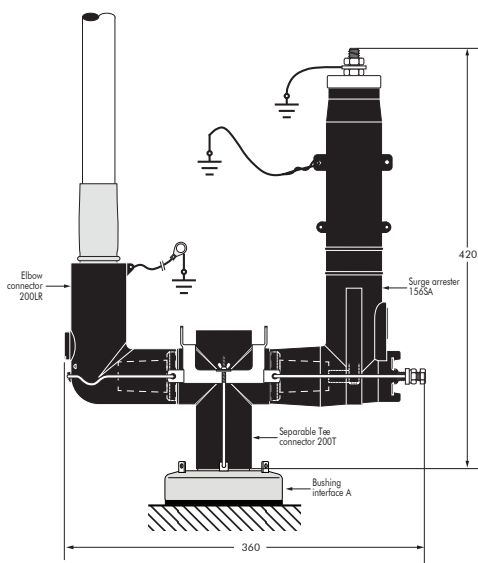

### 200SR+200T+200SR

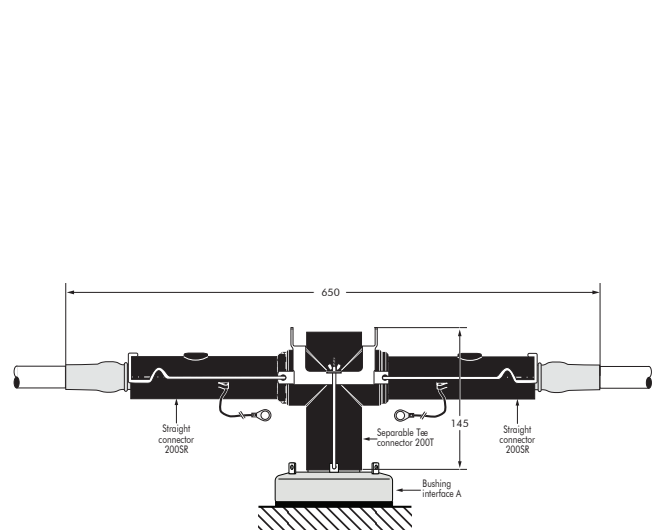

200LR+200SR+200X+200LR

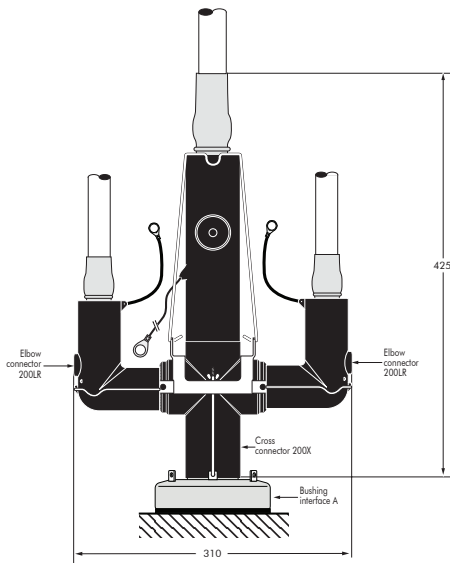

200SR+200LR+200X+200SR

