

ACCESSORIES

APPLICATION

For use with connectors and bushings with an interface C as described by CENELEC EN 50180 and 50181.

TECHNICAL CHARACTERISTICS

All these products, except the earthing plugs, are tested for AC withstand and partial discharge prior to leaving the factory.

6/10 (12) kV
6.35/11 (12) kV
8.7/15 (17.5) kV
12/20 (24) kV
12.7/22 (24) kV
18/30 (36) kV
19/33 (36) kV
20.8/36 (42) kV

400DR-B/G DEAD-END RECEPTACLE

Fits over a bushing with a type C interface to provide 'dead-end' facility. The dead-end receptacle is supplied with an earth lead.

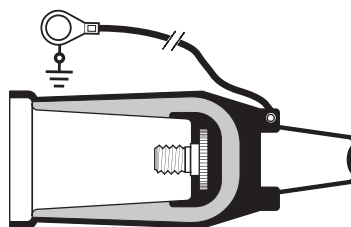

ORDERING INSTRUCTIONS

Order
400DR-B/G for 12 kV,
K400DR-B/G for 24 kV or
M400DR-B/G for 36 kV
applications.

400SOP-B STAND-OFF PLUG

Is designed to support and 'dead-end' connectors with a type C interface when removed from equipment.

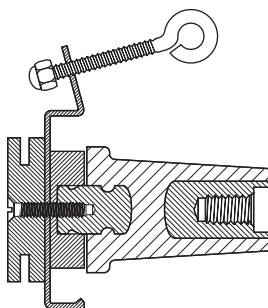

ORDERING INSTRUCTIONS

Order
400SOP-B for 12 kV,
K400SOP-B for 24 kV,
M400SOP-B for 36 kV or
P400SOP-B for 42 kV
applications.

400GP-B EARTHING PLUG

Is designed to support and earth connectors with a type C interface when removed from equipment.

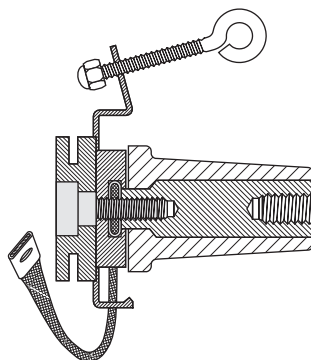

ORDERING INSTRUCTIONS

Order
400GP-B for 12, 24, 36 or
42 kV applications.

08/2021

400BIPA BASIC INSULATING PLUG

Acts as a tightening nut for the 400TB and 440TB tee connector kits.

The plug contains a voltage detection point.

The conductive rubber protection cap is included.

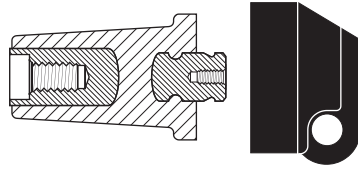

ORDERING INSTRUCTIONS

Order
400BIPA for 12 kV,
K400BIPA for 24 kV
M400BIPA for 36 kV or
P400BIPA for 42 kV
applications.

400CP CONNECTING PLUG

For connecting two or more connectors with a type C interface together, thus creating a separable cable joint or a multiple cable connection to equipment.

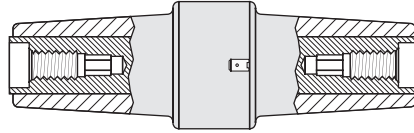

ORDERING INSTRUCTIONS

Order
400CP for 12 kV,
K400CP for 24 kV or
M400CP for 36 kV
applications.

For use up to 630 A.

440CP CONNECTING PLUG

For connecting two or more connectors with a type C interface together, thus creating a separable cable joint or a multiple cable connection to equipment.

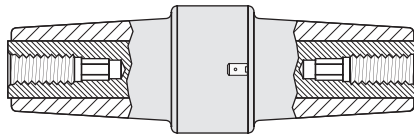

ORDERING INSTRUCTIONS

Order
440CP for 12 kV,
K440CP for 24 kV or
M440CP for 36 kV
applications.

For use up to 1250 A.

400RTPA REDUCING TAP PLUG

Provides a type A interface to connectors with a type C interface. A 'C' spanner, 600SW, is used to tighten the reducing tap plug on to its mating part.

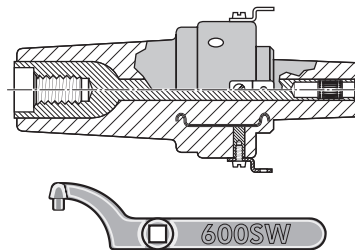

ORDERING INSTRUCTIONS

Order
400RTPA for 12 kV or
K400RTPA for 24 kV
applications.

Order 600SW for the 'C'
spanner.

KIT MT EARTHING KIT FOR COPPER TAPE SCREENED CABLES

Contains a tinned copper braid (25 mm² - L = 500 mm), a tinned copper wire for cleating and some water sealing mastic.

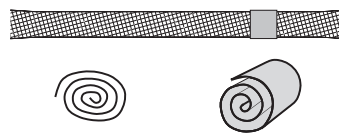

ORDERING INSTRUCTIONS

Order
Kit MT for 12 kV, 24 kV
36 kV or 42 kV applications.

400BE/G BUSHING EXTENDER

Provides an extension piece to allow cables to stand away from equipment.

Is used in conjunction with the 400CP, 440CP or 440PB. The bushing extender is supplied with an earth lead.

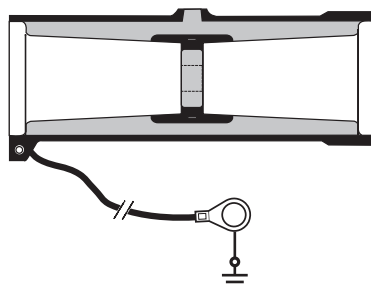

ORDERING INSTRUCTIONS

Order 400BE/G for 12 kV,
K400BE/G for 24 kV,
M400BE/G for 36 kV or
P400BE/G for 42 kV
applications.