



SECTION 06: CABLE BASKET SYSTEMS



A strong, yet flexible solution is needed to meet the demands of the power, data and systems cabling installed in modern buildings.

The patented, EasyConnect® Cable Basket system provides that solution. Adhering to Unitrunk's RIS (Rapid Installation Systems) philosophy, the integral coupler simply pushes together to form a secure joint, no additional couplers or special tools are required.

Manufactured to comply with BS EN 61537, EasyConnect® meets all load test and earth continuity requirements of the standard.

EasyConnect® has been short circuit tested in accordance with DIN 4102-12 and has achieved a fire rating of E90.

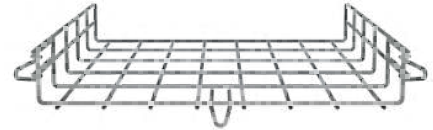

ALL SIDE OR BASE MOUNTED
COUPLERS ARE INTEGRAL

Modular Fabrication

EasyConnect® Cable Basket is manufactured with an overall length of 3000mm. When two lengths are joined, the proximity of the joint means that the two lengths have a combined overall length of 6000mm. This makes it perfect for use in Modular (off-site) fabrication as this eliminates "basket creep" that would occur with other basket products.

EasyConnect® cable basket is patented and manufactured by Valdinox and distributed in the UK & Ireland exclusively through Unitrunk.

ACCREDITED TO THE FOLLOWING STANDARDS:

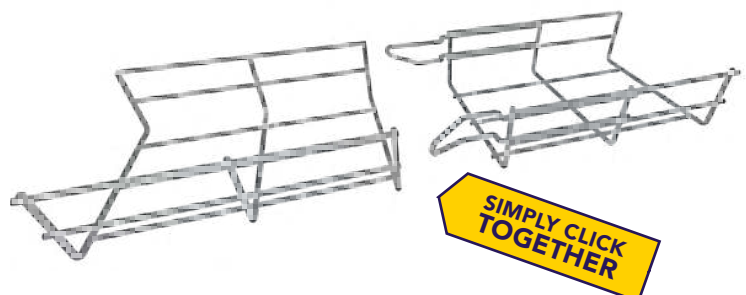

CABLE BASKET SYSTEMS

EasyConnect® Cable Basket

(30mm side height)

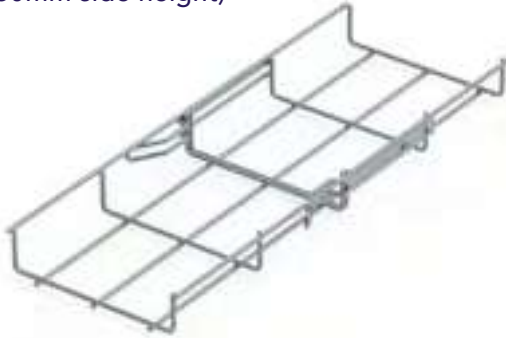

Stock length 3000mm.
Other dimensions and finishes are available on request, including Hot Dip Galvanised and Stainless Steel.

Electro Zinc Plated

Part Code	Width mm	Wire Ø(mm)		Weight kg/m	Cross Section cm ²
		Length	Beam		
EC 30.060 EZ	60	3.9	3.9	0.500	18.78
EC 30.100 EZ	100	3.9	3.9	0.550	26.87
EC 30.150 EZ	150	3.9	3.9	0.700	42.42
EC 30.200 EZ	200	3.9	3.9	0.820	57.97
EC 30.300 EZ	300	4.3	4.3	1.350	87.43

EasyConnect® Cable Basket

(100mm side height)

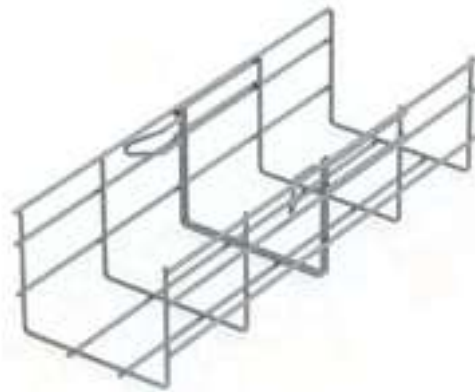

Stock length 3000mm.
Other dimensions and finishes are available on request, including Hot Dip Galvanised and Stainless Steel.

Electro Zinc Plated

Part Code	Width mm	Wire Ø(mm)		Weight kg/m	Cross Section cm ²
		Length	Beam		
EC 100.150 EZ	150	4.3	4.3	1.350	139.24
EC 100.200 EZ	200	4.3	4.3	1.640	191.04
EC 100.300 EZ	300	4.3	4.8	2.200	292.68
EC 100.400 EZ	400	4.6	4.8	2.800	395.88
EC 100.500 EZ	500	4.6	4.8	3.200	499.08
EC 100.600 EZ	600	4.6	4.8	3.600	602.28

PLEASE NOTE:

EasyConnect® is also available in a 150mm side wall on request.

EasyConnect® Cable Basket

(60mm side height)



Stock length 3000mm.
Other dimensions and finishes are available on request.

Electro Zinc Plated

Part Code	Width mm	Wire Ø(mm)		Weight kg/m	Cross Section cm ²
		Length	Beam		
EC 60.060 EZ-6W	60	3.9	3.9	0.720	25.75
EC 60.100 EZ	100	3.9	3.9	0.770	48.47
EC 60.150 EZ	150	3.9	3.9	0.935	76.52
EC 60.200 EZ	200	3.9	3.9	1.070	104.57
EC 60.300 EZ	300	4.3	4.3	1.643	158.63
EC 60.400 EZ	400	4.3	4.8	2.200	211.86
EC 60.450 EZ	450	4.6	4.8	2.420	238.53
EC 60.500 EZ	500	4.6	4.8	2.800	266.73
EC 60.600 EZ	600	4.6	4.8	3.200	321.93

Hot Dip Galvanised*

Part Code	Width mm	Wire Ø(mm)		Weight kg/m	Cross Section cm ²
		Length	Beam		
EC 60.060 HDG	60	3.9	3.9	0.800	25.75
EC 60.100 HDG	100	3.9	3.9	0.860	48.47
EC 60.150 HDG	150	3.9	3.9	1.020	76.52
EC 60.200 HDG	200	3.9	3.9	1.200	104.57
EC 60.300 HDG	300	4.3	4.3	1.820	158.63
EC 60.400 HDG	400	4.3	4.8	2.380	211.86
EC 60.450 HDG	450	4.6	4.8	2.660	238.53
EC 60.500 HDG	500	4.6	4.8	3.080	266.73
EC 60.600 HDG	600	4.6	4.8	3.560	321.93

Stainless Steel*

Part Code	Width mm	Wire Ø(mm)		Weight kg/m	Cross Section cm ²
		Length	Beam		
EC 60.060 IN	60	4.0	3.9	0.740	25.50
EC 60.100 IN	100	4.0	3.9	0.840	48.16
EC 60.150 IN	150	4.0	3.9	0.970	76.16
EC 60.200 IN	200	4.0	3.9	1.140	104.16
EC 60.300 IN	300	4.4	4.3	1.740	158.13
EC 60.400 IN	400	4.4	4.8	2.100	211.75
EC 60.450 IN	450	4.4	4.8	2.300	238.46
EC 60.500 IN	500	4.4	4.8	2.460	266.95
EC 60.600 IN	600	4.4	4.8	2.830	322.15

PLEASE NOTE:

Stainless Steel basket available in 304 & 316 Grades.

CABLE BASKET SYSTEMS

Divider Strip

Part Code	Height mm	Weight kg/pc
SEP30SZ	30	1.410
SEP60SZ	60	1.752
SEP100SZ	100	2.505

Divider Fast Fix Strip

Part Code	Pack Qty	Weight kg/pc
CSEPSZ	50	0.012

Divider Support



Part Code	Pack Qty	Weight kg/pc
SPSDVJB	50	0.019

Basket Lid



Part Code	Width mm (X)	Weight /Unit
T060SZ	60	0.545
T100SZ	100	0.665
T150SZ	150	0.905
T200SZ	200	1.145
T300SZ	300	1.905
T400SZ	400	2.465
T500SZ	500	3.465
T600SZ	600	4.105

Click lid system is supplied in 2m lengths. Finished in Pre Galv. or Stainless Steel. Basket shown for illustration only.

Joint Connector



Part Code	Pack Qty	Weight kg/pc
UUEZ	100	0.027

Central Hanger (threaded rod type)



Part Code	Height mm	Weight kg/pc
SC6CH	25	0.032
SC8CH	25	0.032
SC10CH	25	0.032

Support Clamp



Part Code	Pack Qty	Weight kg/pc
FASEZ	100	0.084

Hold Down Clamp (for EC60.060 basket)



Part Code	Pack Qty	Weight kg/pc
CPUZF	20	0.013

Hold Down Clamp (to suit 100mm - 600mm wide basket)



Part Code	Pack Qty	Weight kg/pc
SC6EZ	50	0.016
SC8EZ	50	0.016
SC10EZ	50	0.016

Slotted Steel Strap

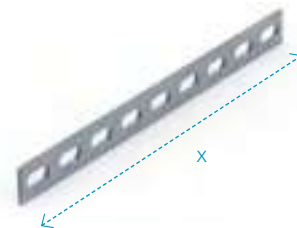

20mm wide strap, used to create bends and tees.

Part Code	Length mm (X)	Pack Qty	Weight /Unit
BKSTP270	270	10	0.108
BKSTP1000	1000	10	0.400

CABLE BASKET SYSTEMS

06

M-Clic Joint Connector



Stainless Steel*

Part Code	Pack Qty	Weight kg/pc	Wire
MCLIC-ZF-3.9	100	0.084	3.9mm
MCLIC-ZF-4.3	100	0.087	4.3mm
MCLIC-ZF-4.8	100	0.091	4.6mm to 4.8mm

MCLIC-ZF-3.9			MCLIC-ZF-4.3			MCLIC-ZF-4.8		
Basket	L	C	Basket	L	C	Basket	L	C
EC30.060	✓	✓	EC30.300	✓	✓	EC60.400	✗	✓
EC30.100	✓	✓				EC60.500	✓	✓
EC30.150	✓	✓	EC60.300	✓	✓	EC60.600	✓	✓
EC30.200	✓	✓	EC60.400	✓	✓			
						EC100.300	✗	✓
EC60.060	✓	✓	EC100.150	✓	✓	EC100.400	✓	✓
EC60.100	✓	✓	EC100.200	✓	✓	EC100.500	✓	✓
EC60.150	✓	✓	EC100.300	✓	✗			
EC60.200	✓	✓						



L - Length Wire
C - Beam Wire



M-CLIC CONNECTOR

Fast Bends, Tees & Reducers

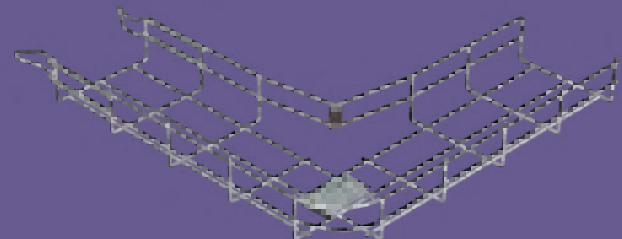
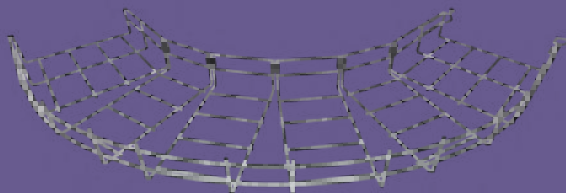

FAST, SECURE & FLEXIBLE

Designed for fast assembly of joints, reducing time and installation costs.



visit us online at unitrunk.co.uk | unitrunk.ie

QuickFix Trunking

QuickFix Multi Compartment Trunking

Lighting Trunking

Uniklip Cable Tray

Speedway Cable Ladder Pre-Galv. Cable Ladder

Cable Basket Systems

Channel & Support

Floor Trunking

Bench Outlet & Perimeter Trunking

Steel Conduit (Class 4)

Innovative Design Solutions

Accessories & Supports

Index

CABLE BASKET SYSTEMS

Side Suspension Hanger



Part Code	Pack Qty	Weight kg/pc
BKSH	50	0.025

Support Spacer



Part Code	Pack Qty	Weight kg/pc
ENTSZ	20	0.027

Support Spacer (ENTSZ) should be used with the wall bracket (SOC) & ceiling bracket (SOPC)

Stand Off Bracket

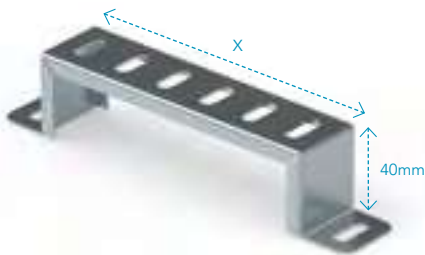

Part Code	Length mm (X)	Weight /Unit
SOB100	100	0.063
SOB150	150	0.103
SOB225	225	0.156
SOB300	300	0.210
SOB450	450	0.252
SOB600	600	0.291

This 40mm high bracket can be used as a floor stand off for either mounted mesh basket or cable tray. It can also be used as a wall stand off. Finished in Pre-Galvanised Steel to (BS EN ISO 10346). Stainless Steel and Hot Dip Galvanised are also available. Sold individually.

Clic Stand Off Bracket

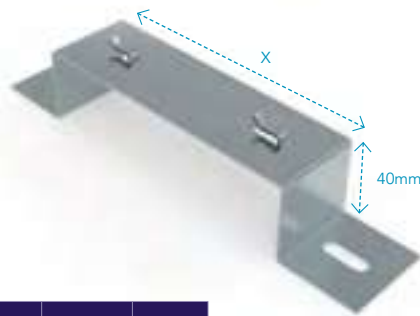

Part Code	Length mm (X)	Pack Qty
SD60SZ	60	48
SD100SZ	100	48
SD150SZ	150	32
SD200SZ	200	32
SD300SZ	300	16
SD400SZ	400	16

CABLE BASKET SYSTEMS

06

Ceiling Support Bracket



Part Code	Length mm (X)	Pack Qty	Weight /Unit
SOPC10SZ	215	16	0.517
SOPC15SZ	265	12	0.550
SOPC20SZ	315	8	0.623
SOPC30SZ	415	8	0.714

For fixing to horizontal concrete ceiling and walls. Finished in Pre-Galv. Stainless Steel and Hot Dip Galvanised are also available.

Wall Support Bracket

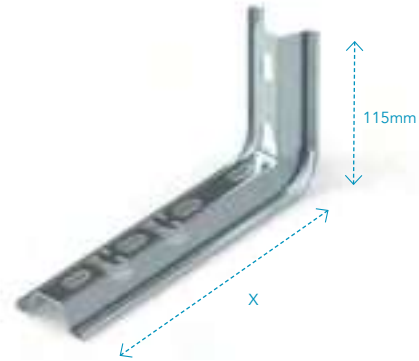

Part Code	Length mm (X)	Pack Qty	Weight /Unit
SOC10SZ	100	10	0.342
SOC15SZ	150	10	0.395
SOC20SZ	200	10	0.447
SOC30SZ	300	10	0.554
SOC40SZ	400	10	0.660

For fixing to walls, use in tandem with Support spacer. Finished in Pre-Galv. Stainless Steel and Hot Dip Galvanised are also available.

Suspension Support Bracket



Part Code	Length mm (X)	Pack Qty	Weight / Unit
SOA10SZ	100	10	0.211
SOA15SZ	150	10	0.251
SOA20SZ	200	10	0.386
SOA30SZ	300	10	0.496
SOA40SZ	400	10	0.632
SOA50SZ	500	10	0.713
SOA60SZ	600	10	0.822

Suspension bracket with Clic connection. Finished in Pre-Galv. Stainless Steel and Hot Dip Galvanised are also available.

EASY BRACKETS

Mount Ceiling, Wall & Suspension Brackets with just a CLIC

SECURE & FAST

SIMPLY FOLD DOWN TABS TO SECURE

QuickFix Trunking

QuickFix Multi Compartment Trunking

Lighting Trunking

Uniklip Cable Tray

Speedway Cable Ladder Pre-Galv. Cable Ladder

Cable Basket Systems

Channel & Support

Floor Trunking

Bench Outlet & Perimeter Trunking

Steel Conduit (Class 4)

Innovative Design Solutions

Accessories & Supports

Index

CABLE BASKET SYSTEMS

Conduit Take Off Bracket

Suitable for $\varnothing 20$ & $\varnothing 25$ conduit

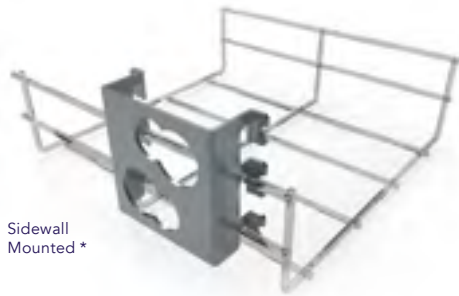

Sidewall Mounted *



Base Mounted **

Part Code	Weight kg/pc
BKCB20-25	0.485

*Fitted on sidewall (EC.60 & EC.100 ranges)
 ** Fitted on base (EC.30, EC.60 & EC.100 ranges)
 Basket shown for illustration purposes only.

Wall Support Clic Bracket



Part Code	Weight kg/pc
SESZ	0.046

Drop Out Plate



Part Code	Weight kg/pc
SC-S	50

Wall Mounting Bracket

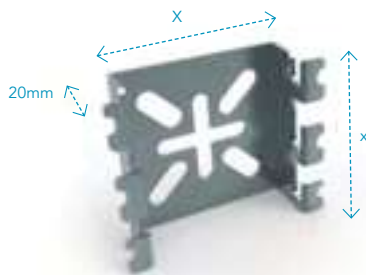

Part Code	Length mm (X)	Weight /Unit
BKMP65	65	0.840
BKMP90	90	1.056

Plastic End Cap



Part Code	Pack Qty.
INVSO	20

CABLE BASKET SYSTEMS

Basket to Channel Clip

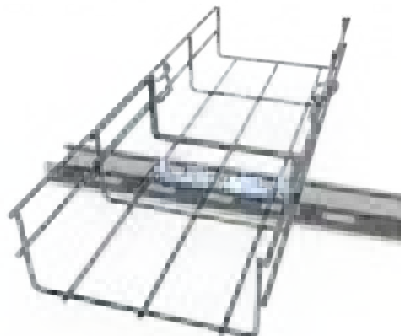

Part Code	Pack Qty	Weight kg/pc
UFC41M	50	0.018

Basket & Channel shown for illustration purposes only.

**FAST,
SECURE,
SIMPLE.**

Wall Support Bracket 30mm



Part Code	Weight kg/pc
PSA30SZ	0.725

Wall or Box Support Bracket 60mm



Part Code	Pack Qty	Weight kg/pc
PS60SG	20	0.550

Other finishes available on request.

Earthing Clamp

Screw-fixed Lug to provide earthing point.

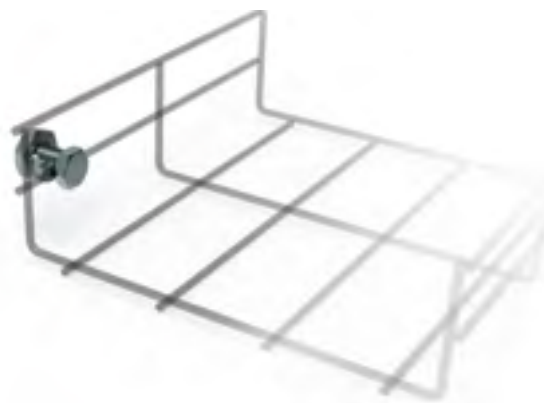

Part Code	Pack Qty
MAT	50

QuickFix Trunking

QuickFix Multi Compartment Trunking

Lighting Trunking

Uniklip Cable Tray

Speedway Cable Ladder Pre-Galv. Cable Ladder

Cable Basket Systems

Channel & Support

Floor Trunking

Bench Outlet & Perimeter Trunking

Steel Conduit (Class 4)

Innovative Design Solutions

Accessories & Supports

Index

CABLE BASKET SYSTEMS

Plastic ID Tag



Part Code	Pack Qty	Colour
BKIDO	1	Orange
BKIDY	1	Yellow
BKIDB	1	Blue
BKIDG	1	Green

To allow contractor to colour code and index cable installations.

Bolt Cutter



Part Code	Max Wire Ø mm	Weight kg/pc
BFR/CUTTERS	7	1.594

Bolt cutter complete with 30° offset jaw and flush cut.

Basket Loading Information

Safe Working Loads EC30

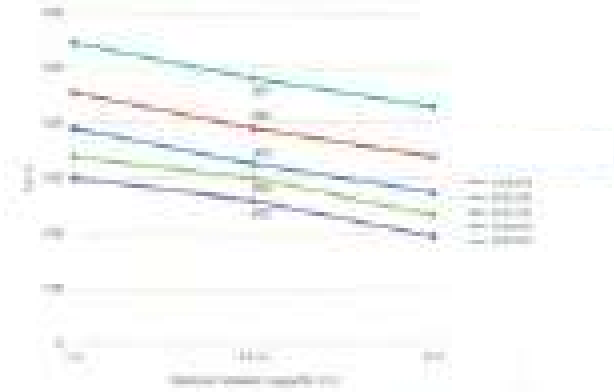

Safe Working Loads EC60

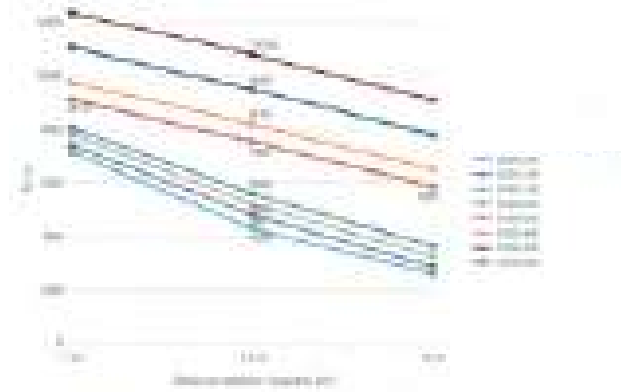

Safe Working Loads EC100

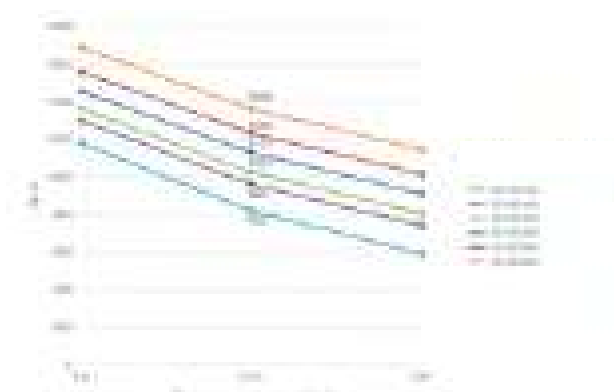

DORSET COUNTY MUSEUM

06



CLIENT



£16m

Overall cost of project

M&E Contractor:
Spectrum Electrical

BACKGROUND

A multi-million pound redevelopment project to create new galleries, a learning centre, collections storage, a library and visitor facilities, with a vision of creating a cultural destination at the heart of Dorset's community.

"Great products with rapid installation... a pleasure to work with you guys. All products arrived on time, correct and when required."

Wayne Evans, Site Manager
Spectrum Electrical

PRODUCTS SUPPLIED

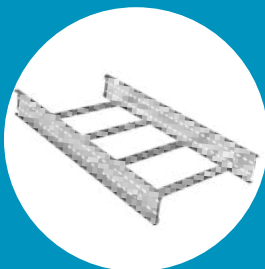

**SPEEDWAY®
LADDER**

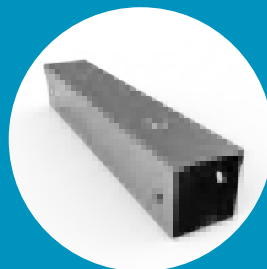

**UNITRUNK
TRUNKING**

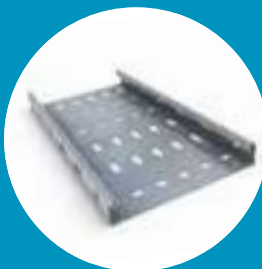

**UNIKLIP®
TRAY**

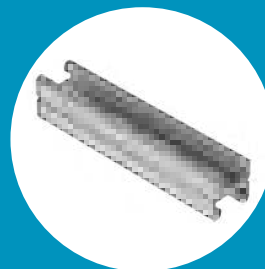

**INTELOK
SUPPORT SYSTEM**