

# POSI GRIP®

Ex db IIC, Ex eb IIC, Ex ta IIIC, Ex nR IIC

COMPRESSION GLAND for Unarmoured Cable



## Features and Benefits

- For highly corrosive Group II, III, Zone 1, 2, 20, 21 and 22 hazardous areas.
- Complete with a gripper seal, deluge proof seal and elastomeric inner seal for complete explosion and ingress protection IP65/66/68.
- Brass parts are encapsulated in and protected by a corrosion-resistant material.
- Marine-grade electroless nickel plated entry threads.
- Precision manufactured from high-quality brass (Marine Grade Electroless Nickel Plated™).
- Supplied with a thread sealing gasket.



## Technical Data

Type:	Posi Grip®	
Gland Material:	Brass (Marine Grade Electroless Nickel Plated™) encapsulated in Nylon or Glass Reinforced Polyester	
Seal Material:	Standard Thermoset Elastomer	
Cable Type:	Unarmoured	
Sealing Area:	Outer Sheath	
Optional Accessories:	Adaptor, Reducer, Locknut and Serrated Washer	
Note:	The installer should ensure that the materials are suitable for the installation environment.	

## Standards and Certifications

Equipment Protection Levels:	IECEX/INMETRO: Ex db IIC Gb, Ex eb IIC Gb, Ex nR IIC Gc, Ex ta IIIC Da ATEX/UKEX: Ex II 2/3G 1D, Ex db IIC Gb, Ex eb IIC Gb, Ex nR IIC Gc, Ex ta IIIC Da TR CU: 1Ex d IIC Gb X / 1Ex e IIC Gb X / 2Ex nR IIC Gc X / Ex tb IIIC Db X	
Continuous Operating Temp:	-20°C to +95°C (Glass reinforced polyester) -60°C to 100°C (Nylon)	
Conformance:	Standard:	Certificate:
IEC/BS EN	IEC/BS EN 62444	CML 14CA364
IECEX	IEC 60079 Part 0, 1, 7, 15, 31	IECEX CML 18.0018X
ATEX	EN 60079 Part 0, 1, 7, 31 EN 60079 Part 0, 15	CML 16ATEX1001X CML 16ATEX4002X
UKEX	BS EN 60079 Part 0, 1, 7, 31 BS EN 60079 Part 0, 15	CML 21UKEX1011X CML 21UKEX4006X
INMETRO (Brazil)	ABNT NBR IEC 60079 Part 0, 1, 7, 15, 31	TÜV 15.0483X
TR CU (Russia)	ГОСТ 31610-0, 15, ГОСТ IEC 60079-1 ГОСТ P МЭК 60079-7, 31	EAЭC RU C-ZA.HA91.B.00245/21
SANS	SANS/IEC 60079 Part 0, 1, 7, 15, 31	MASC MS/22-9001X
IP66/68 100m - Parallel	IEC 60529	CML 15Y728
Deluge Protection	DTS-01	CML 14CA370-2
Corrosion Protection	ASTM B117-11, BS EN ISO 3231	EXOVA N968667
Marine ABS	IEC 60079 Part 0, 1, 7, 15, 31, IEC 60529	ABS 20-1952706-1-PDA
DNV-GL	IEC 60079 Part 0, 1, 7, 15, 31, IEC 60529	DNV-GL TAE0000010

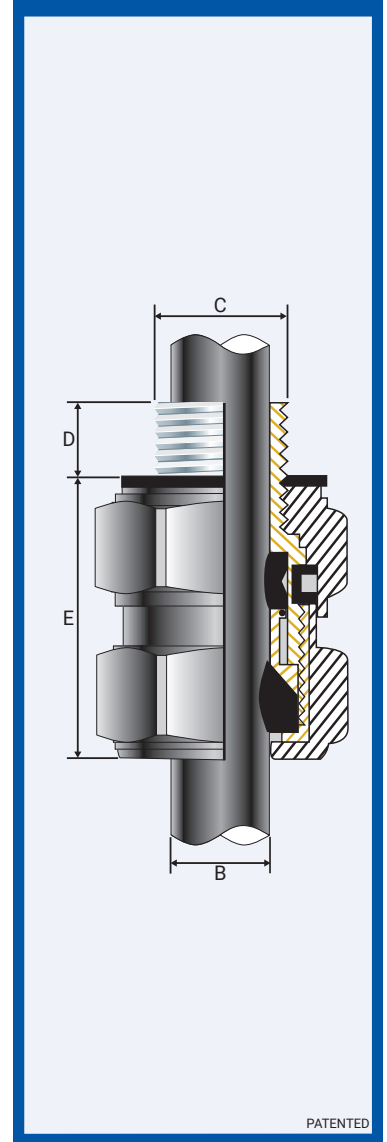

## Conditions for Safe Use - X

- The cable glands shall only be used where the temperature, at the point of entry is between -20°C to +95°C (glass reinforced polyester) or -60°C to 100°C (Nylon).
- The cable gland may only be used on fixed installations where the cable is clamped or stress applied to the cable in the gland is prevented.
- The gland may only be installed / dismantled using CCG Posi™ Spanner.
- According to IEC 60079-14, 10.6.2: An Ex d gland will only maintain Ex d integrity when used with substantially round, compact and filled cable. If not a CCG VORTEX® or QuickStop-Ex® barrier gland should be used.

Product Code	Gland Size Reference	Metric Entry Thread		Cable Detail		Maximum Length 'E'	Hexagonal Detail		*Installation Torque Value Nm
		'C'	Min 'D'	Min 'B'	Max 'B'		Max 'Flats'	Max 'Crns'	
054500	00-20ss	M20x1.5	15	3.0	8.5	42.0	30.0	33.8	14.0
0545-0	0-20s	M20x1.5	15	7.0	12.0	42.0	30.0	33.8	14.0
054501	1-20	M20x1.5	15	9.0	15.0	46.0	34.0	38.3	14.0
054502	2-25	M25x1.5	15	14.0	20.0	51.0	42.0	47.3	20.0
054503	3-32	M32x1.5	15	19.0	26.5	60.0	52.0	58.5	27.0
054504	4-40	M40x1.5	15	26.0	34.0	65.0	62.0	69.8	34.0
054505	5-50	M50x1.5	15	34.0	44.5	75.0	74.0	83.3	40.0
054506	6-63	M63x1.5	15	44.0	56.5	107.0	95.0	106.9	40.0
054507	7-75	M75x1.5	15	56.0	67.5	107.0	111.0	124.9	40.0
054508	8-80	M80x2.0	20	65.0	74.0	128.0	117.0	131.6	40.0
054509	9-90	M90x2.0	20	74.0	81.5	133.0	130.0	146.3	40.0
054510	10-100	M100x2.0	20	81.0	91.0	170.0	140.0	157.5	50.0
054511	11-110	M110x2.0	20	86.0	98.0	170.0	150.0	168.8	50.0

All dimensions are in mm.

\* Only CCG Posi™ Spanner to be used for installation torque.

CCG reserves the right to make alterations to the technical data, dimensions, designs and products available without notice. The illustrations cannot be considered binding. Please contact CCG for assistance.

POSI GRIP-GH01.0622

# POSI GRIP® GLAND

### ENCLOSURES AND EQUIPMENT TO WHICH CABLE GLANDS ARE FITTED:-

- Must be made from materials which are compatible with the cable gland materials.
- Have a sealing area around the cable gland entry point with a surface roughness <math>< Ra 6.3 \mu m</math>.
- Have entries that are perpendicular to the enclosure face in the area where the cable gland will seal to within 2.5°.
- Are sealed using the supplied sealing gasket.

### MUST HAVE THREADED ENTRIES

- The same thread size as the cable gland. (Thread adapters should be used to correct any mismatch).

- With a thread tolerance of metric class '6H' or equivalent.
  - Where the thread length is a minimum of 10mm for Ex d applications or 3mm for all other applications
- OR CLEARANCE HOLES (not Ex d)**
- Where the hole size is the thread nominal size with a tolerance of +0.1 to +0.7mm. (e.g. the clearance hole for an M20 thread will have a diameter between 20.1mm and 20.7mm).
  - Through material that is between 1mm and 12mm thick. (Thicker materials can be accommodated using glands with extended entry threads).

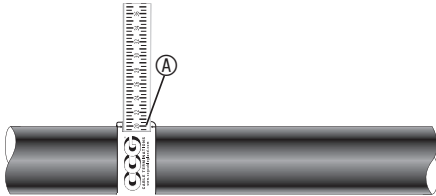

1. For accurate sizing, use a CCG Dimension Tape (A) on the outer cable sheath.

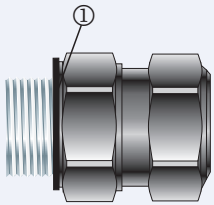

2. To maintain IP66/68, ensure the thread gasket (1) is in place.

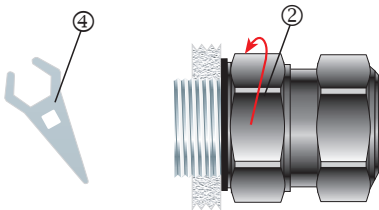

3. Screw the gland unit into the apparatus. Tighten the nipple nut (2) as per torque value using a CCG Posi Spanner (4).

\* Only CCG Posi™ Spanner to be used for installation torque.

Alternative installation through an unthreaded entry.

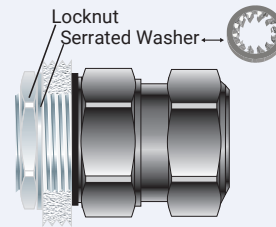

If the apparatus is untapped use a locknut.

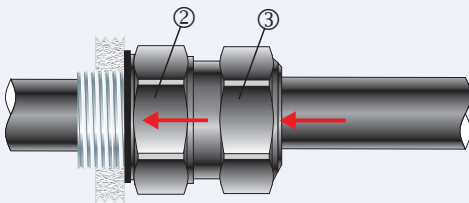

4. Pass the cable end through the outer nut (3) nipple nut (2).

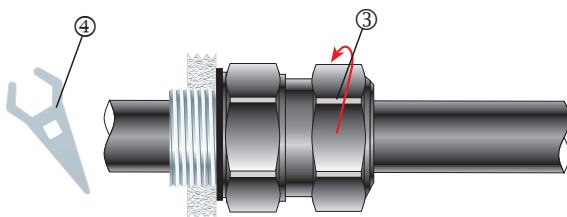

5. Tighten the outer nut (3) using a CCG Posi Spanner (4) as per torque value using a CCG Posi Spanner (4) to produce a seal and grip on the cable.

\* Only CCG Posi™ Spanner to be used for installation torque.