



UNITEx™-D VS

Ex db IIC, Ex eb IIC, Ex ta IIIC, Ex nR IIC

CAPTIVE COMPONENT GLAND® WITH VARIABLE DELUGE SEAL™ for Multi Armoured or Lead Sheathed Cable

Features and Benefits

- For indoors, outdoors, Group II, III, Zone 1, 2, 20, 21 and 22 hazardous areas.
- Two-part handling, no loose parts.
- Freely rotating captive cone and inspectible cone ring provides an armour clamp and earth bond on a steel wire, aluminium, braid and tape armour.
- Patented disconnect system that allows inspection of armour clamp and inner seal after assembly.
- Provides 360° earthing to copper tape or lead sheath.
- With a patented Variable Deluge Seal™ as standard.
- Factory fitted with a specially formulated elastomeric seal for Built-in Safety™, seals on the inner and outer sheath of the cable to IP65/66/68.
- Precision manufactured from high-quality brass (Marine Grade Electroless Nickel Plated™) available in stainless steel 316/316L on request.
- Supplied with a thread sealing gasket (parallel threads only).



Technical Data

Type:	UNITEx™-D VS
Gland Material:	Brass (Marine Grade Electroless Nickel Plated™), Stainless Steel 316/316L
Seal Material:	Standard Thermoset Elastomer or Extreme Temperature Seals
Sealing Gasket Material:	HDPE, Nylon 66 or PTFE
Cable Type:	Steel Wire, Aluminium, Braided, Copper Tape or Lead Sheathed
Armour Clamping:	Rotating Captive Cone and Inspectible Cone Ring
Sealing Area:	Inner Sheath, Outer Sheath and Variable Deluge Seal™
Optional Accessories:	Adaptor, Reducer, Earth Tag, Locknut, Serrated Washer and Shroud
Note:	The installer should ensure that the materials are suitable for the installation environment.

Standards and Certifications

Equipment Protection Levels:	IECEx/INMETRO: Ex db IIC Gb, Ex eb IIC Gb, Ex nR IIC Gc, Ex ta IIIC Da ATEX/UKEX: Ex II 2/3G 1D, Ex db IIC Gb, Ex eb IIC Gb, Ex nR IIC Gc, Ex ta IIIC Da CCC: Ex db IIC Gb, Ex eb IIC Gb, Ex ta IIIC Da	
Continuous Operating Temp:	Standard Seals: -60°C to +95°C/100°C (HDPE/Nylon Sealing Gasket) Extreme Temp. Seals: -60°C to +160°C (PTFE Sealing Gasket)	
Conformance:	Standard: Certificate:	
IEC/BS EN	IEC/BS EN 62444	CML 14CA364
IECEX	IEC 60079 Part 0, 1, 7, 15, 31	IECEX CML 18.0018X
ATEX	EN 60079 Part 0, 1, 7, 31	CML 16ATEX1001X
	EN 60079 Part 0, 15	CML 16ATEX4002X
UKEX	BS EN 60079 Part 0, 1, 7, 31	CML 21UKEX1011X
	BS EN 60079 Part 0, 15	CML 21UKEX4006X
INMETRO (Brazil)	ABNT NBR IEC 60079 Part 0, 1, 7, 15, 31	TUV 15.0483X
TR CU (Russia)	ГОСТ 31610-0, 15, ГОСТ IEC 60079-1	EAЭC RU C-ZA.HA91.B.00245/21
	ГОСТ P MЭК 60079-7, 31	
CCC/CNEx (Chinese)	GB/T3836.1, 2, 3, 31-2021	CNEx 21.3388X, CCC 2021312313000394 MASC MS/22-9001X CML 15Y728
SANS	SANS/IEC 60079 Part 0, 1, 7, 15, 31	
IP66/68 850m - Parallel	IEC 60529	
IP65 - Tapered	IEC 60529	
IP68 - Tapered and approved grease	IEC 60529	IECEX CML 18.0018X
Deluge Protection	DTS-01	CML 14CA370-2
Corrosion Protection	ASTM B117-11, BS EN ISO 3231	EXOVA N968667
Marine ABS	IEC 60079 Part 0, 1, 7, 15, 31, IEC 60529	ABS 20-1952706-1-PDA
DNV-GL	IEC 60079 Part 0, 1, 7, IEC 60529	DNV-GL TAE0000010
EMC Compatible	EN 55011, + A1, EN 55022	SGS EMC305079/1



Conditions for Safe Use - X

- The cable glands shall only be used where the temperature, at the point of entry, is between -60°C to +95°C (standard seal & HDPE sealing gasket), -60°C to +100°C (standard seal and Nylon sealing gasket) or -60°C to +160°C (extreme temp. seal & PTFE sealing gasket) depending on seal and gasket used.
- Braided cables must only be used on fixed installations where the cable is clamped or stress applied to the cable in the gland is prevented.

Note: According to IEC 60079-14, 10.6.2: An Ex d gland will only maintain Ex d integrity when used with substantially round, compact and filled cable. If not a CCG VORTEX® barrier gland should be used.

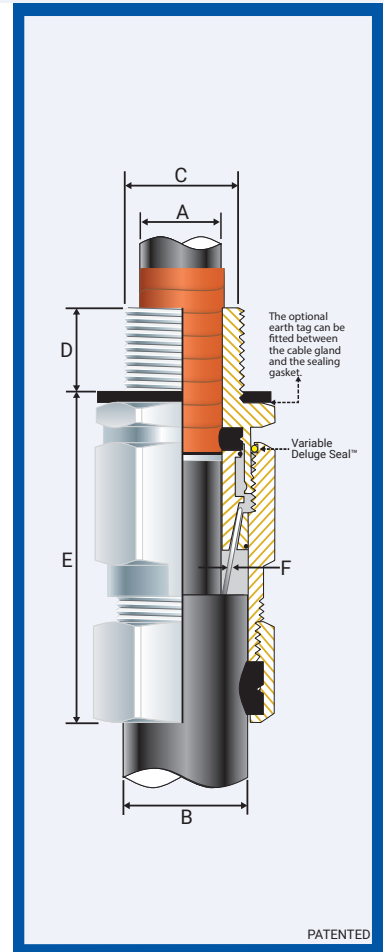

Product Code	Gland Size Reference	Metric Entry Thread		NPT Entry Thread		Cable Detail				Max Length 'E'	Armour Dia		Hexagonal Detail		Install. Torque Value Nm
		'C'	Min 'D'	'C'	Min 'D'	Min 'A'	Max 'A'	Min 'B'	Max 'B'		Min 'F'	Max 'F'	Max 'Flats'	Max 'Crns'	
050400S-16	00s-16ss	M16x1.5	15	-	-	3.0	8.5	5.0	10.5	74.0	0.2	0.9	24.0	27.0	21.0
050400S	00s-20ss	M20x1.5	15	1/2 3/4	15	3.0	8.5	5.0	10.5	74.0	0.2	0.9	24.0	27.0	21.0
050400	00-20ss	M20x1.5	15	1/2 3/4	15	3.0	8.5	8.0	14.0	73.0	0.2	0.9	24.0	27.0	21.0
0504-0S-16	0s-16s	M16x1.5	15	-	-	7.0	12.0	8.0	14.0	70.0	0.2	1.25	24.0	27.0	21.0
0504-0S	0s-20s	M20x1.5	15	1/2 3/4	15	7.0	12.0	8.0	14.0	70.0	0.2	1.25	24.0	27.0	21.0
0504-0	0-20s	M20x1.5	15	1/2 3/4	15	7.0	12.0	11.5	16.0	70.0	0.2	1.25	24.0	27.0	21.0
050401	1-20	M20x1.5	15	1/2 3/4	15	9.0	15.0	12.5	20.5	83.0	0.2	1.25	27.0	30.0	21.0
050422	2s-25s	M25x1.5	15	3/4 1	15/19	11.0	17.5	16.0	24.5	96.0	0.2	1.60	35.0	39.0	30.0
050402	2-25	M25x1.5	15	3/4 1	15/19	14.0	20.0	18.0	27.0	96.0	0.2	1.60	35.0	39.0	30.0
050433	3s-32s	M32x1.5	15	1 1/4	19	15.0	22.0	20.0	30.5	111.0	0.2	2.00	42.0	47.0	42.0
050403	3-32	M32x1.5	15	1 1/4	19	19.0	26.5	23.0	33.5	111.0	0.2	2.00	42.0	47.0	42.0
050444	4s-40s	M40x1.5	15	1 1/2 1 1/2	19/21	22.0	31.5	26.5	39.0	112.0	0.3	2.00	52.0	59.0	52.0
050404	4-40	M40x1.5	15	1 1/2 1 1/2	19/21	26.0	34.0	28.0	40.0	117.0	0.3	2.00	52.0	59.0	52.0
050455	5s-50s	M50x1.5	15	1 1/2 2	21	29.0	38.0	35.2	47.5	131.0	0.4	2.50	65.0	73.0	57.0
050405	5-50	M50x1.5	15	1 1/2 2	21	34.0	44.5	44.4	52.8	136.0	0.4	2.50	65.0	73.0	57.0
050466	6s-63s	M63x1.5	15	2 2/2 2	21/30	38.0	50.0	45.5	60.5	148.0	0.4	2.50	80.0	90.0	66.0
050406	6-63	M63x1.5	15	2 2/2 2	21/30	44.0	56.5	54.6	65.9	148.0	0.4	2.50	80.0	90.0	66.0
050477	7s-75s	M75x1.5	15	2 2/2 3	30/32	50.0	62.0	59.0	72.5	174.0	0.4	3.15	96.0	108.0	72.0
050407	7-75	M75x1.5	15	2 2/2 3	30/32	56.0	67.5	65.0	78.0	173.0	0.4	3.15	96.0	108.0	72.0
050408	8-80	M80x2.0	20	3	32	59.0	69.0	65.0	77.5	166.0	0.4	3.15	96.0	108.0	80.0
050499	9s-90s	M90x2.0	20	3 3/3 2	32/33	66.0	75.0	73.0	86.5	185.0	0.4	3.50	111.0	125.0	89.0
050409	9-90	M90x2.0	20	3 3/3 2	32/33	74.0	81.5	82.0	91.0	185.0	0.4	3.50	111.0	125.0	89.0
050410	10-100	M100x2.0	20	3 3/2 4	33/34	81.0	91.0	90.0	100.0	204.0	0.4	3.50	125.0	141.0	98.0

All dimensions except NPT are in mm. Intermediate thread sizes are available on request. NPT threads should be tightened 'wrench tight'.

CCG reserves the right to make alterations to the technical data, dimensions, designs and products available without notice. The illustrations cannot be considered binding. Please contact CCG for assistance. UNITEx-D VS-OMG300523E

UNITEx™ -D VS GLAND

ENCLOSURES AND EQUIPMENT TO WHICH CABLE GLANDS ARE FITTED:-

- Must be made from materials which are compatible with the cable gland materials.
- Have a sealing area around the cable gland entry point with a surface roughness <math>< Ra 6.3 \mu m</math>.
- Have entries that are perpendicular to the enclosure face in the area where the cable gland will seal to within 2.5°.
- Are sealed using the supplied sealing gasket (parallel threads) or by fully tightening into a threaded entry (tapered threads). Note that for tapered threads the IP rating can be improved to IP68 with the use of a suitable thread sealant.

MUST HAVE THREADED ENTRIES

- The same thread size as the cable gland. (Thread adapters should be used to correct

any mismatch).

- With a thread tolerance of metric class '6H' or equivalent.
- Where the thread length is a minimum of 10mm for Ex d applications or 3mm for all other applications

OR CLEARANCE HOLES (not Ex d)

- Where the hole size is the thread nominal size with a tolerance of +0.1 to +0.7mm. (e.g. the clearance hole for an M20 thread will have a diameter between 20.1mm and 20.7mm).
- Through material that is between 1mm and 12mm thick. (Thicker materials can be accommodated using glands with extended entry threads.)

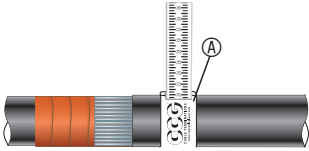

1. For accurate sizing, use a CCG Dimension Tape (A) on the inner and outer cable sheath.

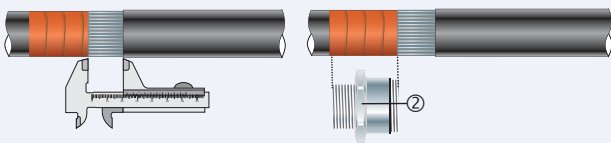

Gland Size	Armour Length	Gland Size	Armour Length	Gland Size	Armour Length	Gland Size	Armour Length
00-16ss	20.0	3s-32s	30.0	6s-63s	45.0	9-90	50.0
00-20ss	20.0	3-32	30.0	6-63	45.0	10-100	60.0
0-20s	20.0	4s-40s	30.0	7s-75s	50.0	11-115	60.0
1-20	25.0	4-40	30.0	7-75	50.0	12-120	60.0
2s-25s	25.0	5s-50s	35.0	8-80	50.0	13-130	60.0
2-25	25.0	5-50	35.0	9s-90s	50.0		

2. Cut back the cable outer sheath to expose the armour to a length as per the table above. Cut the PVC sheath exposing the copper tape or lead sheath to the length of the inner (2).

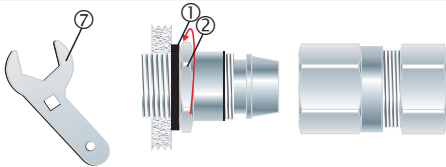

3. To maintain IP66/68, ensure the gasket (1) is in place. Screw the inner (2) into the apparatus. Tighten the inner (2) to the installation torque using a CCG Spanner (7).

Alternative installation through an unthreaded entry.

If the apparatus is unthreaded use a locknut.

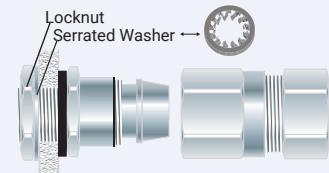

If the gland has NPT entry threads fitted to a threaded entry then IP68 (2m) can be achieved by applying one of the following tested and approved grease types to the thread:- Renolit Lubrene CA700 or LX220 EP2, Renolit LC-WP2 or Moly LX2, or Dow Corning 4 Electrical Compound.

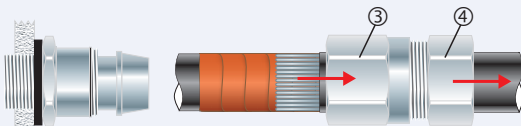

4. Pass the outer nut (4) and the body (3) over the cable.

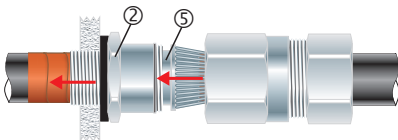

5. Pass the cable end through the inner (2) ensure the copper tape does not unravel. Splay the armour wires over the cone (5).

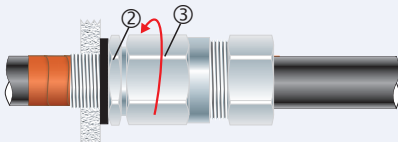

6. Tighten the body (3) onto the inner (2) until hand tight, then tighten with a CCG Spanner (7) with 3/4 turn to lock the armour between the cone (5) and the cone ring (6).

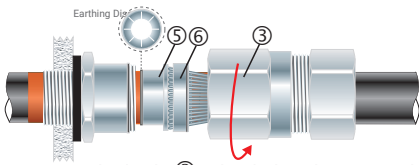

7. Unscrew the body (3). Check that the armour is locked between the cone (5) and cone ring (6). (O-Ring on the cone ring (6) is sacrificial). Check the copper tape or lead sheath has passed through and makes 360° contact with the earthing disc.

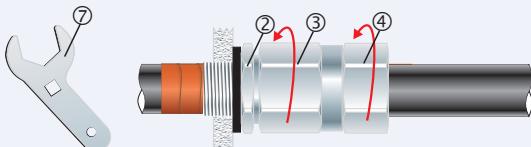

8. Tighten the body (3) onto the inner (2) to the installation torque using a CCG Spanner (7). The Variable Deluge Seal™ will engage automatically as the body is tightened onto the inner (2). Tighten the outer nut (4) to produce a moisture proof seal by turning until the seal makes contact with the outer sheath of cable and then make one full turn.