

DATASHEET

DMF4B5R5G105M3DTA0,

5.5V, 1F, 40mΩ, -40°C to +70°C

Revision 1.5, Feb 2021



Electrical Specifications

Table 1: Absolute Maximum Ratings

Parameter	Name	Conditions	Min	Typical	Max	Units
Terminal Voltage	V_{peak}				5.5	V
Temperature	T_{max}		-40		+70	°C

Table 2: Electrical Characteristics

Parameter	Name	Conditions	Min	Typical	Max	Units
Terminal Voltage	V_n		0		5.5	V
Capacitance	C	DC, 23°C	800	1000	1200	mF
ESR	ESR	AC, 1kHz		40	50	mΩ
Leakage Current	I_L	5.5V, 23°C 120hrs			6	μA
RMS Current	I_{RMS}	25°C			5.5	A
Peak Current ¹	I_P	23°C			30	A

¹Non-repetitive current, single pulse to discharge fully charged supercapacitor.

Table 3: Mechanical specification

Length (mm)	Width (mm)	Thickness "T" (mm)	Weight (gm)
30 ± 0.5mm	14 ± 0.5	3.7 (max. 4.0)	1.3

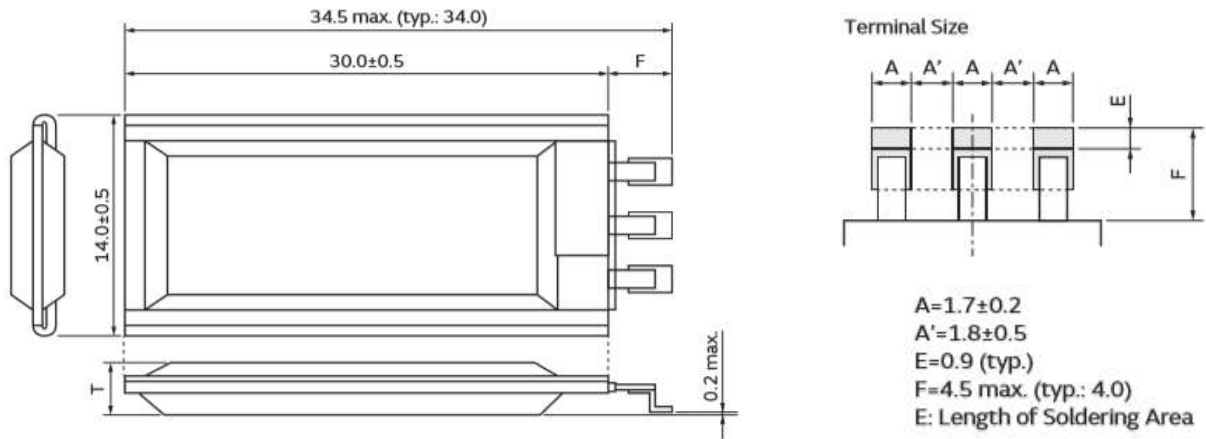

Mechanical drawing for DMF4B5R5G105M3DTA0

Landing Pad Dimensions

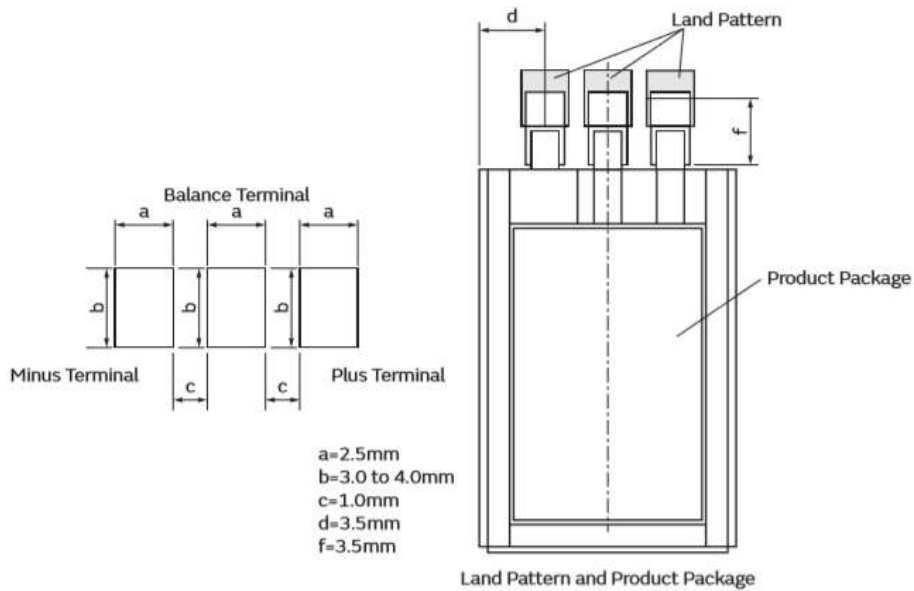

DMF4B5R5G105M3DTA0 DATASHEET

Part Numbering

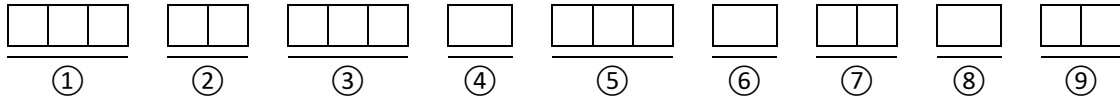

① Series

Code	
DMF	High Peak Power Type

② External Dimensions (L x W x T)

Code	L (mm)	W (mm)	T (mm)
3Z	21.0±0.5	14.0±0.5	3.2 (max 3.4)
4B	30.0±0.5	14.0±0.5	3.7 (max 4.0)

③ Rated Voltage

Code	Rated Voltage
5R5	DC 5.5V

④ ESR

Code	ESR @ 1kHz
H	45mΩ
G	40mΩ

⑤ Nominal Capacitance

First two are significant digits and the third expresses the number of zeroes which follow the two numbers

Code	Nominal Capacitance
105	10x10 ⁵ μF = 1F

⑥ Capacitance Tolerance

Code	Tolerance
M	±20%

⑦ External Terminal

Code	Terminal Specification
3D	3 Terminals (+/-/Balance)

⑧ Packaging

Code	Package Specification
T	Tray type, 50pcs/Tray

⑨ Inhouse Specification Code

Expressed by two-digit alphanumerics

Printing

Capacitance

Series Code + LW Size Code

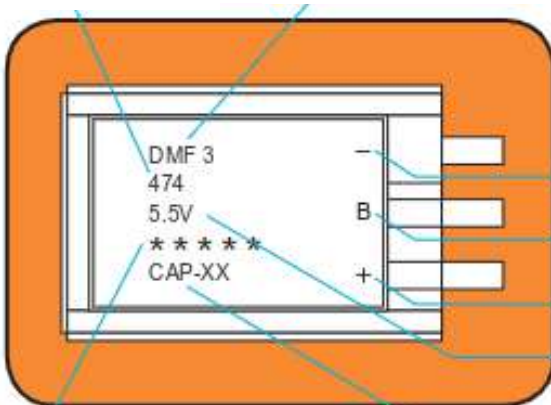

Negative Terminal

Balance Terminal

Positive Terminal

Rated Voltage

Batch ID

Manufacturer (CAP-XX or MURATA)

DMF4B5R5G105M3DTA0 DATASHEET

Batch ID

①	②	③		

① Year

Code	Year
9	2019
A	2020
B	2021
C	2022
D	2023
:	:
Y	2044
Z	2045

② Month

Code	Month
F	January
G	February
H	March
J	April
K	May
L	June
M	July
N	August
P	September
Q	October
R	November
S	December

③ 3-digit Unique ID

This 3 digit number is used to uniquely identify the batch within the month.

Definition of Terms

In its simplest form, the Equivalent Series Resistance (ESR) of a capacitor is the real part of the complex impedance. In the time domain, it can be found by applying a step discharge current to a charged cell as in Fig. 1. In this figure, the supercapacitor is pre-charged and then discharged with a current pulse, $I = 1\text{A}$ for duration 0.01 sec .

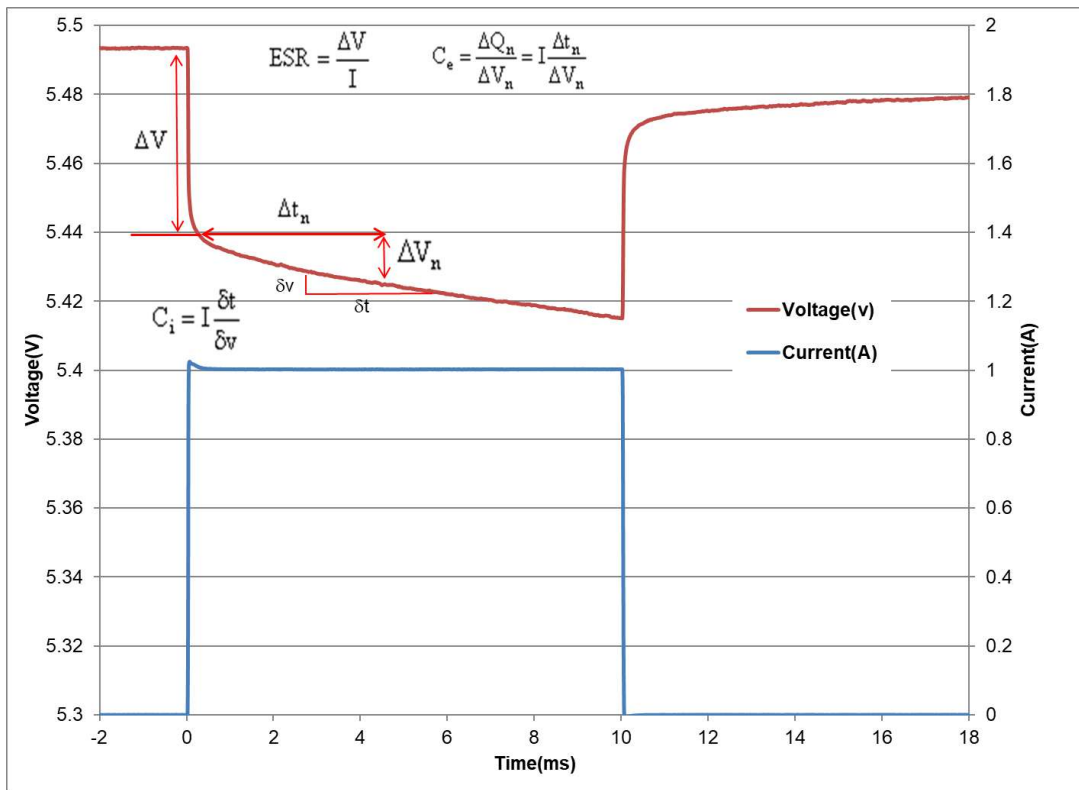

Fig 1: Effective capacitance, instantaneous capacitance and ESR for DMF4B5R5G105M3DTA0

The ESR is found by dividing the instantaneous voltage step (ΔV) by I . In this example $= (5.494\text{V} - 5.452\text{V})/1\text{A} = 42\text{m}\Omega$.

The instantaneous capacitance (C_i) can be found by taking the inverse of the derivative of the voltage, and multiplying it by I .

The effective capacitance for a pulse of duration Δt_n , $C_e(\Delta t_n)$ is found by dividing the total charge removed from the capacitor (ΔQ_n) by the voltage lost by the capacitor (ΔV_n). For constant current $C_e(\Delta t_n) = I \times \Delta t_n / \Delta V_n$. C_e increases as the pulse width increases and tends to the DC capacitance value as the pulse width becomes very long ($\sim 10\text{ secs}$). After 2msecs, Fig 1 shows the voltage drop $V_{2\text{ms}} = (5.452\text{ V} - 5.431\text{V}) = 21\text{mV}$. Therefore $C_e(2\text{ms}) = 1\text{ A} \times 2\text{ms}/21\text{mV} = 95.2\text{mF}$. After 10ms, the voltage drop $= 5.452\text{ V} - 5.415\text{V} = 37\text{mV}$. Therefore $C_e(10\text{ms}) = 1\text{ A} \times 10\text{ms}/37\text{mV} = 270.2\text{mF}$. The DC capacitance of DMF4B5R5G105M3DTA0 = 1F . Note that ΔV , or $I \cdot R$ drop, is not included because very little charge is removed from the capacitor during this time. C_e shows the time response of the capacitor and it is useful for predicting circuit behaviour in pulsed applications.

Measurement of DC Capacitance

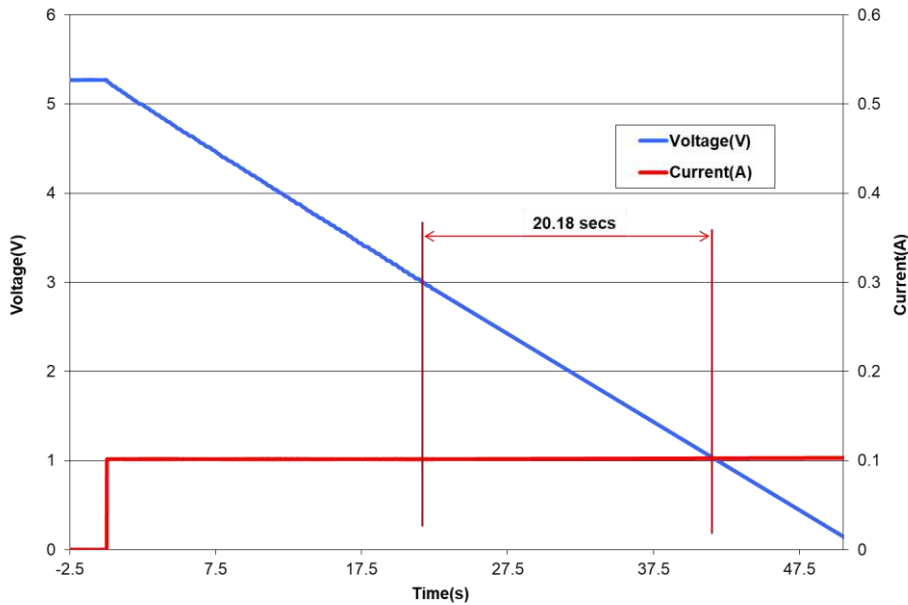

Fig 2: Measurement of DC Capacitance for a DMF4B5R5G105M3DTA0

Fig 2 shows the measurement of DC capacitance by drawing a constant 100mA current from a fully charged supercapacitor and measuring the time taken to discharge from 1.5V to 0.5V for a single cell, or from 3V to 1V for a dual cell supercapacitor. In this case, $C = 0.1A \times 20.18s / 2V = 1.01F$, which is well within the 1F +/- 20% tolerance for a DMF4B5R5G105M3DTA0 cell.

Measurement of ESR

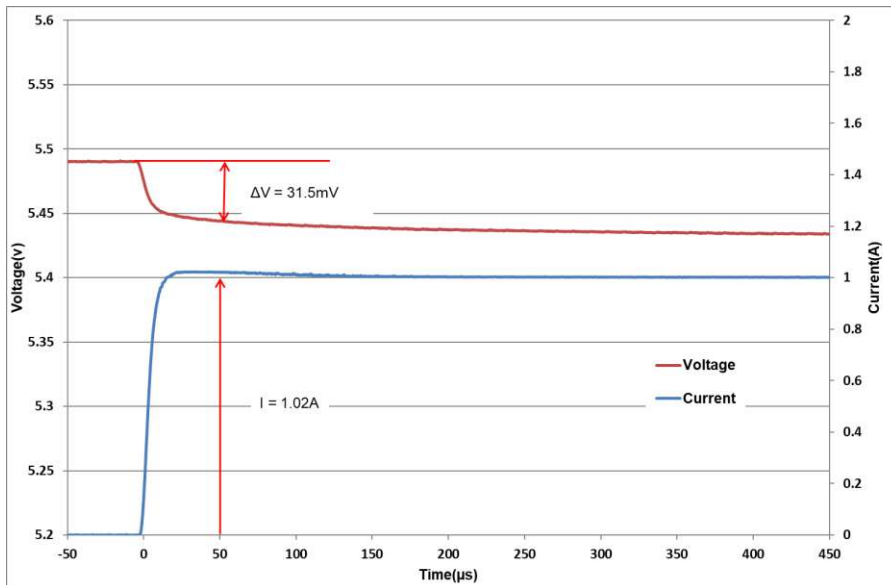

Fig 3: Measurement of ESR for a DMF4B5R5G105M3DTA0

Fig 3 shows DC measurement of ESR by applying a step load current to the supercapacitor and measuring the resulting voltage drop. CAP-XX waits for a delay of 50µs after the step current is applied to ensure the voltage and current have settled. In this case the ESR is measured as $31.5mV / 1.02A = 30.9m\Omega$.

Effective Capacitance

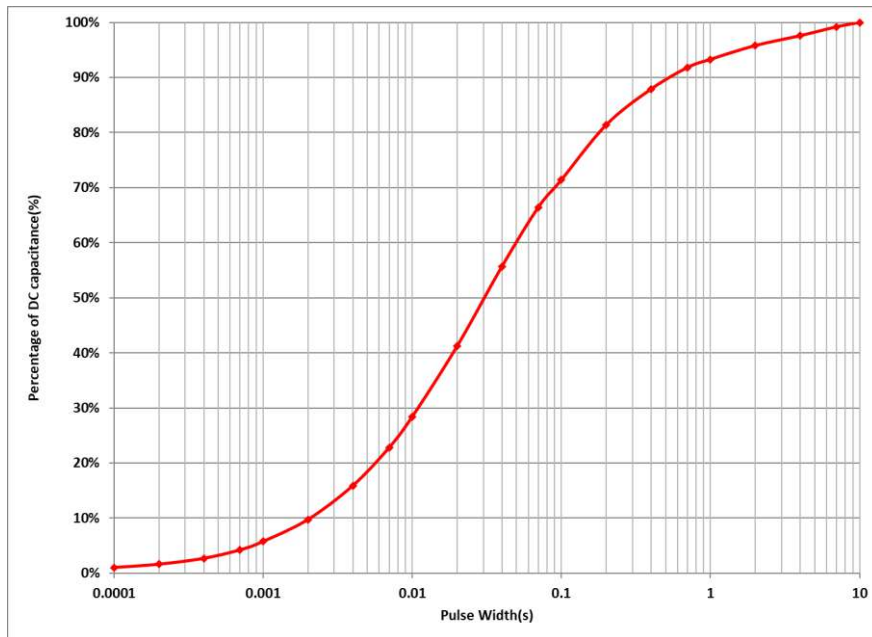

Fig 4: Effective Capacitance

Fig 4 shows the effective capacitance for the DMF4B5R5G105M3DTA0 @ 23°C. This shows that for a 1ms PW, you will measure 6% of DC capacitance or 60mF. At 10msecs you will measure 28% of the DC capacitance, and at 100msecs you will measure 71% of DC capacitance. Ceffective is a time domain representation of the supercapacitor's frequency response. If, for example, you were calculating the voltage drop if the supercapacitor was supporting 1A for 10msecs, then you would use the $C_{eff}(10msecs) = 28\% \text{ of DC capacitance} = 280mF$, so $V_{drop} = 1A \times ESR + 1A \times \text{duration}/C = 1A \times 40m\Omega + 1A \times 10ms / 280mF = 76mV$. The next section on pulse response shows how the effective capacitance is sufficient for even short pulse widths.

Pulse Response

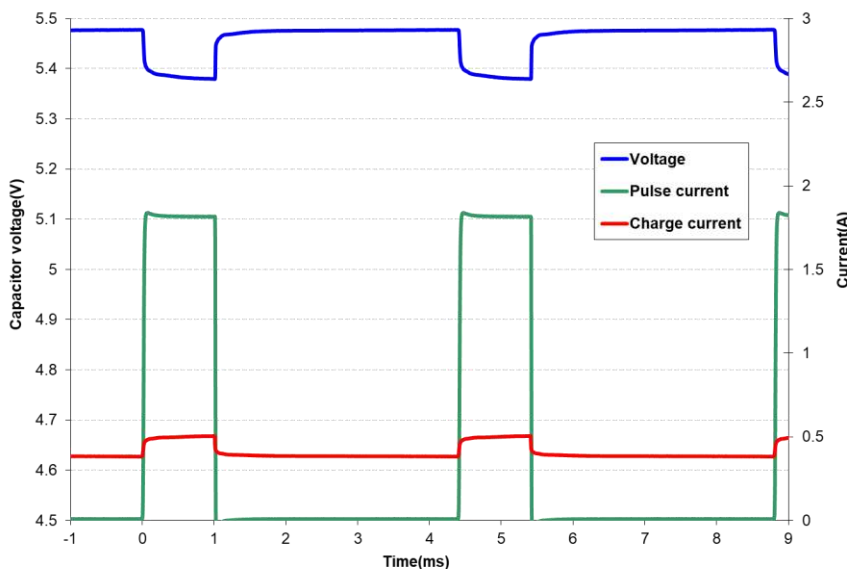

Fig 5 shows that the DMF supercapacitor does an excellent job supporting a GPRS class 10 pulse train, drawing 1.8A for 1.1ms at 25% duty cycle. The source is current limited to 0.6A and the supercapacitor provides the 1.2A difference to achieve the peak current. At first glance the freq response of Fig 8 indicates the supercapacitor would not support a 1ms pulse, but the C_{eff} of 60mF coupled with the low ESR supports this pulse train with only ~90mV droop in the supply rail.

Fig 5: DMF4B5R5G105M3DTA0 Pulse Response with GPRS Class 10 Pulse Train

DC Capacitance variation with temperature

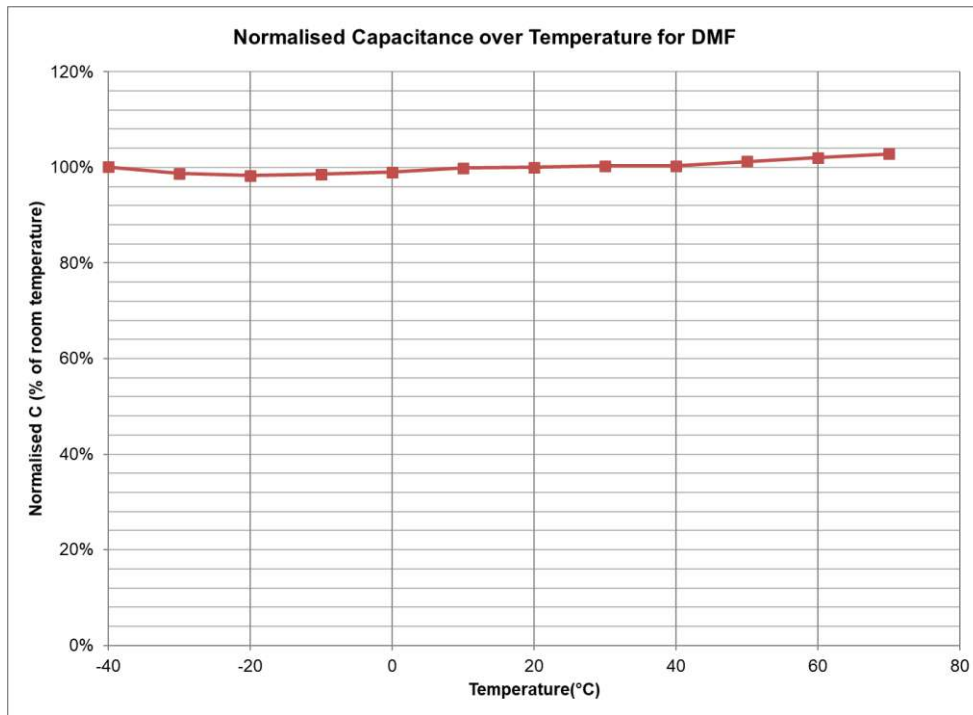

Fig 6: Capacitance change with temperature

Fig 6 shows that DC capacitance is approximately constant with temperature.

ESR variation with temperature

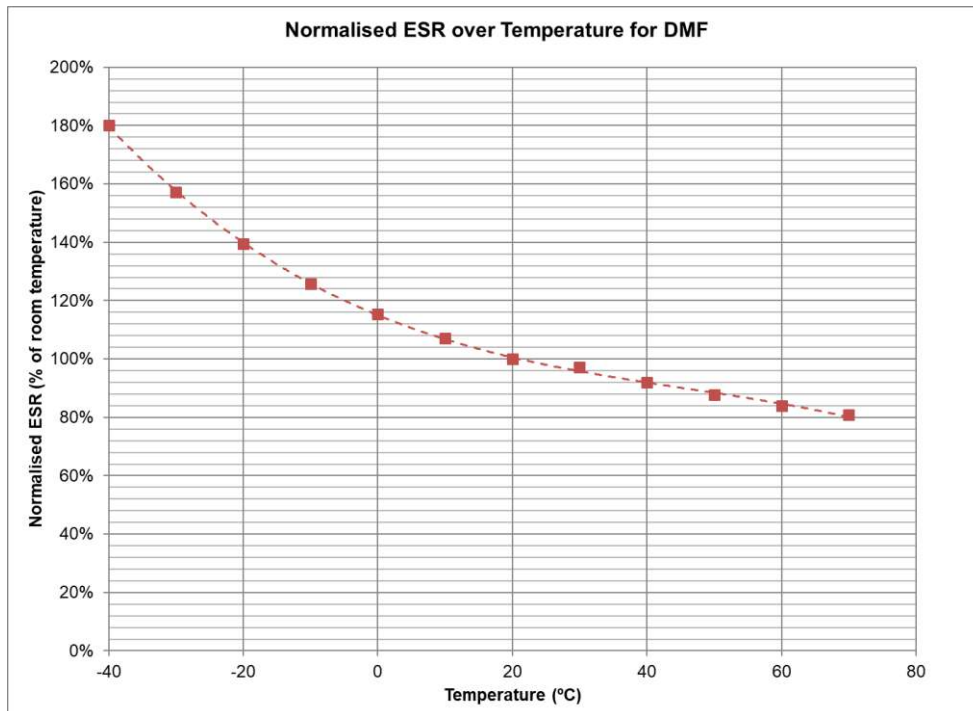

Fig 7: ESR change with temperature

Fig 7 shows that ESR at -40°C is ~1.8 x ESR at room temp, and that ESR at 70°C is ~0.8 x ESR at room temperature.

Frequency Response

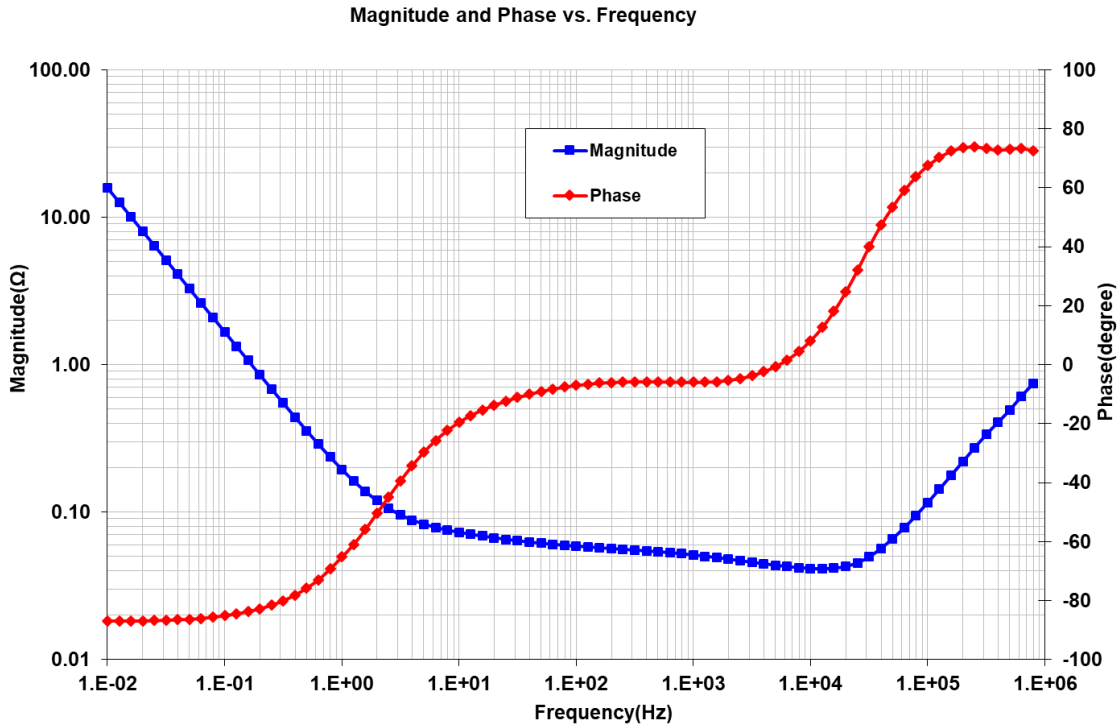

Fig 8: Frequency Response of Impedance (biased at 5.5V with a 50mV test signal)

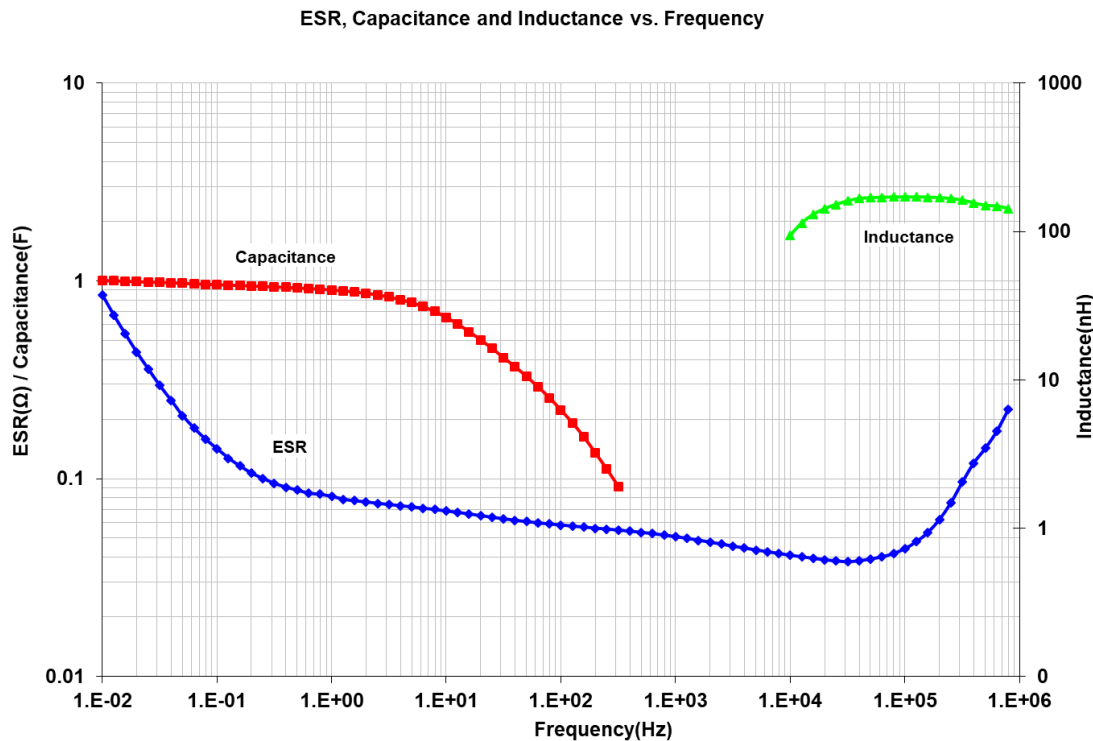

Fig 9: Frequency Response of ESR, Capacitance & Inductance

Fig 8 shows the supercapacitor behaves as an ideal capacitor until approx. 2.2 Hz when the magnitude no longer rolls off proportionally to $1/\text{freq}$ and the phase crosses -45° . Performance of supercapacitors with frequency is complex and the best predictor of performance is Fig 4 showing effective capacitance as a function of pulse width.

Leakage Current

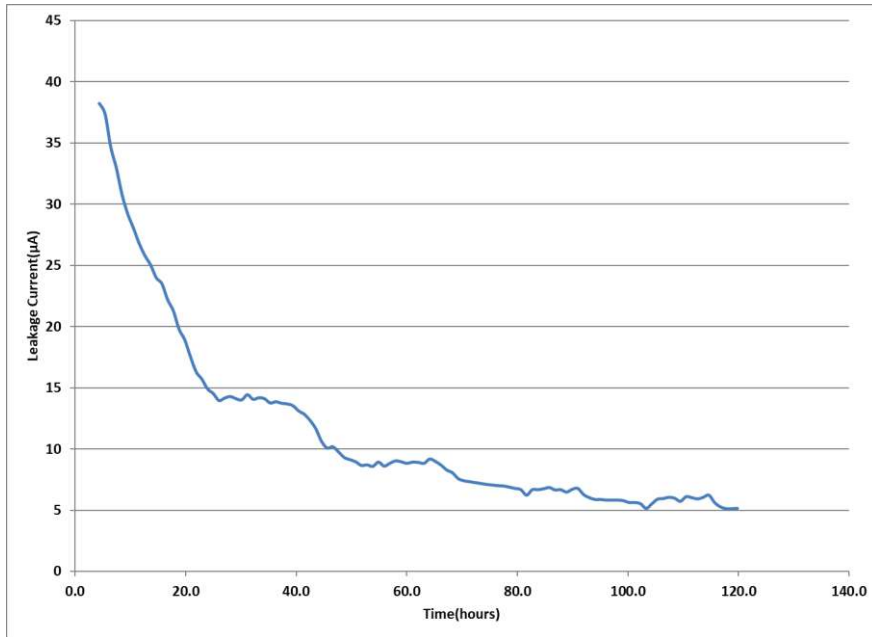

Fig 10: Leakage Current

Fig 10 shows the leakage current for DMF4B5R5G105M3DTA0 at room temperature. The leakage current decays over time, and the equilibrium value leakage current will be reached after ~120hrs at room temperature. The typical equilibrium leakage current is 5µA at room temperature.

Charge Current

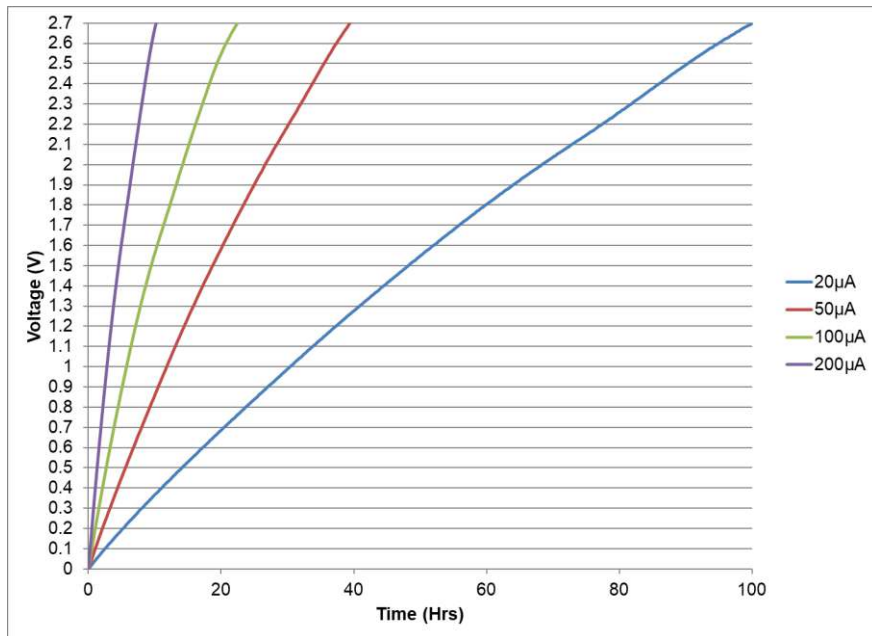

Fig 11: Charging a single cell of DMF4B5R5G105M3DTA0 (single cell: 2F) with low current

The corollary to the slow decay in leakage currents shown in Fig 10 is that charging a supercapacitor at very low currents takes longer than theory predicts. At higher charge currents, the charge rate is as theory predicts. For example, it should take $2F \times 2.7V / 0.00002A = 75hrs$ to charge a 2 F supercapacitor to 2.7V at 20µA, but Fig 11 shows it took 100hrs. At 100µA charging occurs at a rate close to the theoretical rate.

DMF4B5R5G105M3DTA0 DATASHEET

RMS Current

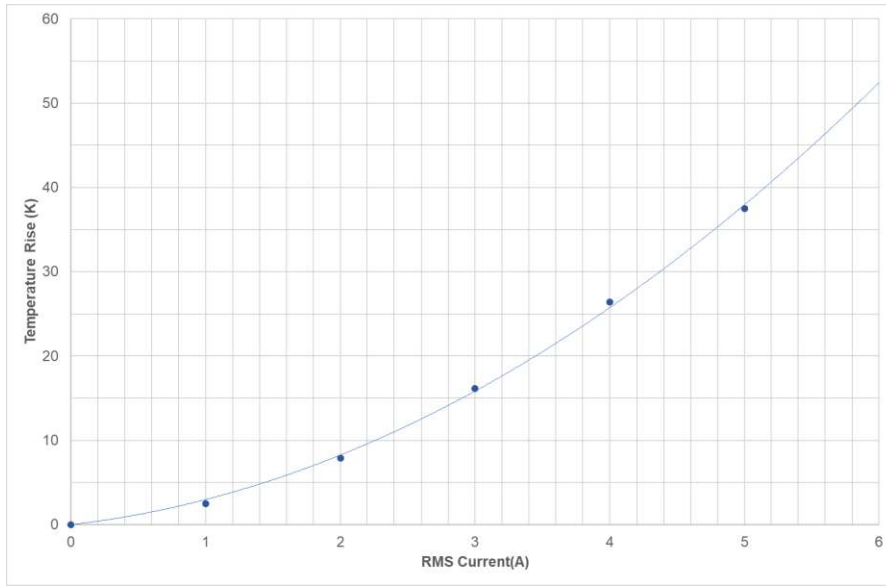
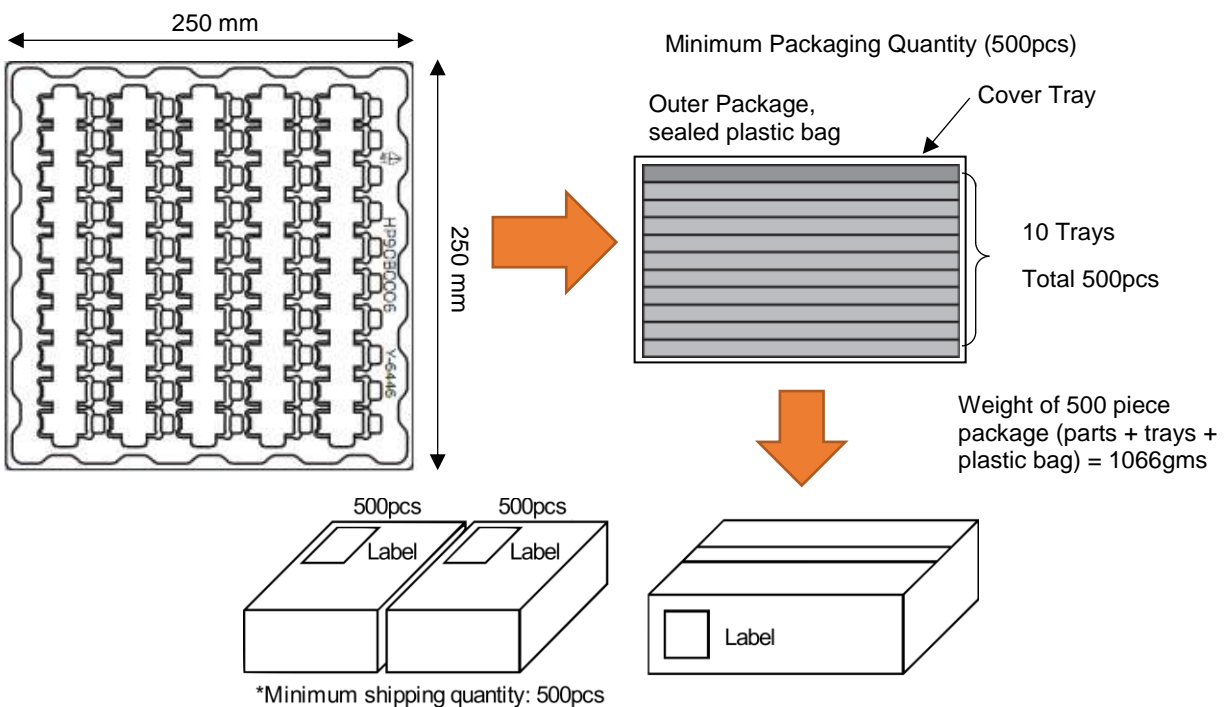

Fig 12: Temperature rise in DMF4B5R5G105M3DTA0 with RMS current

Continuous current flow into/out of the supercapacitor will cause self-heating, which limits the maximum continuous current the supercapacitor can handle. This is measured by a current square wave with 50% duty cycle, charging the supercapacitor to rated voltage at a constant current, then discharging the supercapacitor to half rated voltage at the same constant current value. For a square wave with 50% duty cycle, the RMS current is the same as the current amplitude. Fig 12 shows the increase in temperature as a function of RMS current. From this, the maximum RMS current in an application can be calculated, for example, if the ambient temperature is 40°C, and the maximum desired temperature for the supercapacitor is 70°C, then the maximum RMS current should be limited to 4.4A, which causes a 30°C temperature increase.

Packaging

DMF4B5R5G105M3DTA0



Storage

CAP-XX recommends storing supercapacitors in their original packaging in an air-conditioned room at < 30°C and < 60% relative humidity. CAP-XX supercapacitors can be stored at any temperature not exceeding their maximum operating temperature but storage at continuous high temperature and humidity is not recommended and will cause premature ageing.

Do not store supercapacitors in the following environments:

- High temperature / high humidity
- Direct sunlight
- In direct contact with water, salt, oil or other chemicals
- In direct contact with corrosive materials, acids, alkalis or toxic gases
- Dusty environment
- In environments subjected to shock and vibration

Cautions before use

CAP-XX supercapacitors are “burned in” during production, and have a defined polarity, as shown by the positive terminal marked on the face of the product. Reversing the polarity of the device will not damage the device but may cause a rise in the ESR and will void the warranty. Please verify the orientation of the supercapacitor in accordance with the product markings before assembly.

CAP-XX supercapacitors are heat-sensitive. Over-heating of the supercapacitor may result in a degradation of performance and useful life.

CAP-XX supercapacitors must only be used within their rated voltage range. Over-voltage may cause swelling and eventually, product failure.

CAP-XX supercapacitors are fully discharged when shipped. Devices should be handled and soldered in a discharged state.

Soldering and Assembling

CAP-XX supercapacitors are designed for direct soldering onto the PCB. Soldering the terminals to the PCB will ensure the highest contact reliability and lowest contact resistance. Do NOT solder directly to the device casing. This will cause permanent internal damage to the supercapacitor.

CAP-XX supercapacitors are NOT SUITABLE for infrared reflow soldering, hot-air reflow soldering, or wave soldering. They should be mounted as a secondary operation, using a manual soldering iron, a hot bar soldering jig, conductive adhesive, ultrasonic welding or laser welding.

CAP-XX recommends the use of a water-soluble flux, or a no-clean (low residue) flux, and low temperature solder compounds.

Please solder under the following conditions:

- Solder Type: Resin flux cored solder wire (ø1.2mm)
- Solder: Lead-free solder: Sn-3Ag-0.5Cu
- Soldering iron temperature at 350°C±10°C
- Solder iron wattage: 70W or less
- Soldering time: 3 to 4sec.
- The same terminal should be soldered 3 or less times.

If a hot-air gun is used to reflow the solder during a re-mount or de-mount, care must be taken to prevent excessive heating of the package adjacent to the solder terminals. Allow at least 15 sec between successive soldering attempts for the device to cool down.

Please consult CAP-XX if you wish to wash the device after soldering.

Vibration and Shock Testing

Shock

CAP-XX has undertaken tests to determine the effects of repeated shocks on both the mechanical integrity and electrical performance of its supercapacitors:

Charge to rated voltage at 500mA for min. 30min

- Type: Half-Sine
- Amplitude: 500G
- Duration: 1ms
- No. of cycles: 3 in each direction (18 in total)
- No. of axes: 3, orthogonal

Results: No electrical or mechanical degradation observed.

Note that this test was undertaken on the standard product with adhesive mounting tape (Nitto No.5000NS). To achieve the highest levels of resistance to shock, CAP-XX recommends the use of an adhesive mounting tape on the underside of the device.

Vibration

CAP-XX has undertaken tests to determine the effects of sustained vibration on both the mechanical integrity and electrical performance of its supercapacitors:

Charge to rated voltage at 500mA for min. 30min

- Type: Sinusoidal
- Frequency: 10 ~ 500Hz/10G
- Amplitude: 1.5mm
- Sweep Rate: 1octave/min
- No. of cycles: 10 in each direction
- No. of axes: 3, orthogonal

Results: No electrical or mechanical degradation observed.

Note that this test was undertaken on the standard product with adhesive mounting tape (Nitto No.5000NS). To achieve the highest levels of resistance to shock, CAP-XX recommends the use of an adhesive mounting tape on the underside of the device.

Drop Test

CAP-XX has undertaken tests to determine the effects of repeated drops on both the mechanical integrity and electrical performance of its supercapacitors:

Supercapacitor is discharged

- Mount product to 150g box with adhesive mounting tape (Nitto No.5000NS)
- Drop the box from 0.25m / 0.5m / 1.0m / 1.5m
- Repeat 3 times for 6 sides (18 in total)

Results: No electrical or mechanical degradation observed.