

ELPRESS KEY INDUSTRIES

Electrical Machines

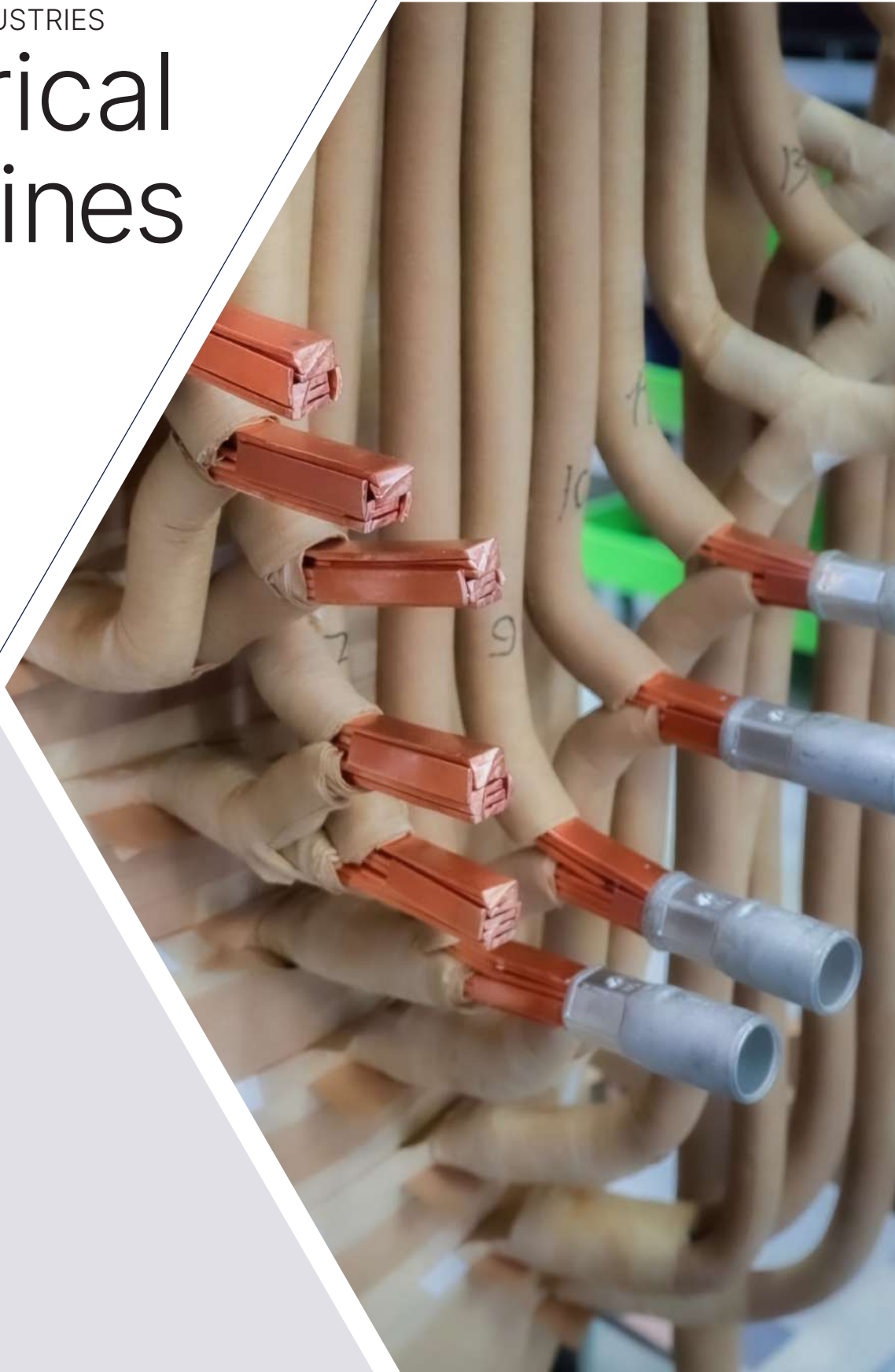

PRODUCT
CATALOGUE

ELPRESS





World Leading Supplier of System Solutions.

Electrical Machines is one of Elpress' key segments where we provide secure and sustainable solutions for tomorrow's electrified society. We are a world leading supplier of system solutions for crimping Winding Conductors and CTC's in combination with round cable types.

Our unique crimping system makes us stand out from the rest where the majority of the leading manufactures of Power Transformers across the world are using System Elpress for their crimping requirements.



What we offer.

Together with a high level of service and product knowledge we make sure that you get a safe and secure electrical connection. When crimping in advanced applications, such as transformer connections, it is necessary that the crimping system has a high level of performance and is reliable. With our extensive knowledge and long experience in the industry, we have developed a complete crimping system where we offer training of operators, certifications and special products.

Elpress' crimping system for Transformer connectors contains:

- Joints, such as terminals and through connectors adapted to transformer conductors
- Electrically powered, hydraulic pumps with ergonomic crimping tools, rounding and crimping dies
- Tested according to international standards
- Qualification of production methods
- Training and certification of operators



Advanced crimping makes reliability, high performance and documentation essential

Crimping system

When crimping in advanced applications as transformers it is essential that the crimping system is a high performance and reliable system. Elpress has developed a wide range of products specialized for these applications. Together with training of operators, certifications and the products this is a complete system concept. Elpress **Crimp System for Transformer connections** is:

- Terminals and connectors adapted to transformer use
- Electrically powered crimp tools with ergonomic crimp heads, rounding and crimp dies
- Test certification to international standards
- Production quality procedures
- Training and certifying of operators



Terminals and connectors

Elpress complete system consists of terminals and connectors from 25 to 630 mm². They have the suffix L which is the customers' guarantee that the connectors are a part of the quality assured system. Special items have been developed, like the straight and angled T-connectors. Markings on the terminals and connectors show tool identification, size, stud hole and manufacturers emblem. The markings are made for easier and correct use.

Tools

With the 13, 25 and 35 tons crimp heads Elpress ensures easy operation both when rounding of winding bundles and when rounding. Elpress offers a mains and/or battery operated hydraulic pump that is controlled from the crimping head handle and powers the crimping head. Rounding and crimping dies are polished for minimising the risk of sharp edges. Winding connections are crimped within the following acceptance range for each connection.

Nominal connector area mm², winding conductor mm²

Nom. connector area	Tot. initial real winding conductor cross section	Tot. initial real winding conductor cross section
mm ²	min mm ²	max mm ²
25	30	47
35	45	70
50	69	103
70	100	120
95	113	161
120	145	185
150	180	220
185	220	265
240	302	343
300	340	400
400	412	500
500	500	580
630	630	730
800	720	960

Tests

Elpress has tested the use of terminals and connectors within the specified cross section area ranges in accordance with IEC 61238-1. This is the most widely accepted test standard with a qualified evaluation of performance stability. Inspection certificates are available from Elpress and can be requested if needed.

Product quality assurance

It is essential to have simple means of identifying correct crimp procedures and results while working. With the Elpress System the dies leave an imprint on the crimped barrel surface showing the die identification. This enables a direct and easy inspection that proper tools have been used. For all crimps a crimp height limit is given to make an easy check of proper tool function by means of a vernier caliper or a gauge.

Operator training

To ensure that operators have the detailed knowledge that is the base for long term quality, Elpress runs theoretical and practical training sessions at each production site resulting in certification of the individual operators. These trained operators will have a qualified level in regard to practical work procedures as well as the precautions that ensure proper results. Please contact Elpress for more information.



Assured results

When you work with the Elpress Crimp System for Transformer Conductor Connections, and follow the instructions for this system, you get results which have been tested to well established standards and requirements. This is your way of getting assured results in production work.



KRF95-8

Marking of tube terminals (L)

20 (on the terminal neck) ID-no. for the hexagonal die

(Elpress logo) 95-8F (on the palm)
 95 = Cu-conductor area, mm²
 8 = hole for screw M18
 F = KRF

Markings on Cu-connections

Elpress marking system for Cu-connectors shows logotype, conductor area and ID-number for crimp die to be used. This system enables final inspection of proper die use as the die number is automatically imprinted by the die on the crimped barrel, see picture above.

Checking measures KRF/KSF, L dies (N-measure)

Type KRF/KSF with B (L) dies

KRF/KSF (L) mm ²	Die no.	max N mm
25	13B11L	8.8
35	13B13L	10.3
50	13B14,5L/13CB14,5L	10.9
70	13B17L/13CB17L	13.5
95	13B20L/13CB20L	16.5
120	13B22L/13CB22L	16.5
150	13B25L/13CB25L/B2525L	20.3
185	13B27L/13CB27L/B2527L	20.6
240	13B30L/13CB30L/B2530L	23.4
300	B2532L	24.6
400	B2538L	30.5
500	B2542L	30.7
630	B2550L	38.5
800	B3553L	38.5



Marking of connectors

(Elpress logo) 25 ID-no. for hexagonal die

150 F
 150 = Cu-conductor area, mm²
 F = KSF

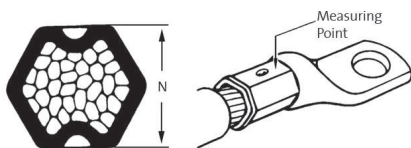

Stud holes in terminal palms

Screw dimension	Hole diameter tolerance H13 (Ø mm)
M3	3.2
M4	4.3
M5	5.3
M6	6.4
M8	8.4
M10	10.5
M12	13
M16	17
M20	21
M24	25

Electrical Machines cross reference table for AWG and MCM for mm²

AWG	Area mm ²	MCM	Area mm ²
36	0.013	250	127
34	0.020	300	152
32	0.032	350	177
30	0.051	400	203
28	0.080	450	228
26	0.13	500	253
24	0.20	550	279
22	0.33	600	304
20	0.56	650	329
19	0.65	700	355
18	0.82	750	380
17	1.04	800	405
16	1.31	850	431
15	1.65	900	456
14	2.08	1000	507
13	2.62	1100	557
12	3.31	1200	608
11	4.17	1300	659
10	5.26	1400	709
9	6.63	1500	760
8	8.37	1600	811
7	10.6	1700	861
6	13.3	1800	912
5	16.8	1900	963
4	21.2	2000	1013
3	26.4		
2	33.6		
1	42.4		
1/0	53.5		
2/0	67.4		
3/0	85.5		
4/0	107		

Notes:

- The information in this table is derived from catalogues distributed by cable suppliers and does not relate to official standards.
- The cross sections that relate to AWG vary depending on different design of the conductors, ie numbers of strands. The exact cross sections for specific numbers of strands can be found in cable-supplier catalogues.

Quality assured systems

We also offer special developed purpose-built products, such as for instance reducer, straight and angled T connectors, to ensure that you have the right crimping solution for your specific application. Our complete system includes connectors from 10 to 800 mm². They have the suffix L, which is the user's guarantee that the component is a part of the quality assured system. The marking on the connector shows ID number for crimping tools, metric size, bolt size (for terminals) and make in the form of the logotype. The marking ensures easy and correct use.

Tube terminals 16 - 630 mm²

- Material: Cu 99.95%, tin plated Cu/Sn.
- Cable inspection hole. For winding, flexible and stranded Cu-conductors.



Marking example KRF: 95 12F, (Elpress logotype included) 20
 95 = mm² 12 = palm hole for M12 F = type KRF, 20 = Die No.

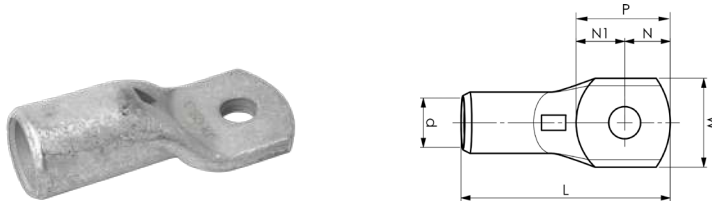

Conductor Cu mm ²	Winding mm ²	Name	Screw	W mm	d	t	N	N1	P	L	s	Tool	Die	Pcs/pack	Note
16	14-22	KRF16-6L	6	13	6	2,9	8	9	17	34	11	V1300	9L	100	
16	14-22	KRF16-8L	8	13	6	2,9	8	9	17	34	11	V1300	9L	100	
16	14-22	KRF16-10L	10	16	6	2,2	10	11	21	38	11	V1300	9L	100	
16	14-22	KRF16-12L	12	22	6	1,6	12	23	25	47	11	V1300	9L	100	
25	30-47	KRF25-6L	6	16	8	2,9	8	10	18	39	13	V1300	11L	100	
25	30-47	KRF25-8L	8	16	8	2,9	8	10	18	39	13	V1300	11L	100	
25	30-47	KRF25-10L	10	17	8	2,9	10	11	21	42	13	V1300	11L	100	
25	30-47	KRF25-12L	12	22	8	2,1	12	13	25	47	13	V1300	11L	100	
35	45-70	KRF35-6L	6	18	9	3,9	10	11	21	47	16	V1300	13L	100	
35	45-70	KRF35-8L	8	18	9	3,9	10	11	21	47	16	V1300	13L	100	
35	45-70	KRF35-10L	10	18	9	3,9	10	11	21	47	16	V1300	13L	100	
35	45-70	KRF35-12L	12	22	9	3,2	12	14	26	52	16	V1300	13L	100	
50	69-103	KRF50-8L	8	21	11	3,4	11	11	22	50	19	V1300	14,5L	100	
50	69-103	KRF50-10L	10	21	11	3,4	11	11	22	50	19	V1300	14,5L	100	
50	69-103	KRF50-12L	12	21	11	3,4	12	13	25	53	19	V1300	14,5L	100	
50	69-103	KRF50-16L	16	27	11	2,7	15	16	31	59	19	V1300	14,5L	100	
70	100-120	KRF70-8L	8	25	13	3,9	11	11	22	55	22	V1300	17L	50	
70	100-120	KRF70-10L	10	25	13	3,9	11	11	22	55	22	V1300	17L	50	
70	100-120	KRF70-12L	12	25	13	3,9	12	13	25	58	22	V1300	17L	50	
70	100-120	KRF70-16L	16	28	13	3,5	15	16	31	64	22	V1300	17L	50	
95	113-161	KRF95-8L	8	29	15	4,9	15	16	31	69	25	V1300	20L	50	
95	113-161	KRF95-10L	10	29	15	4,9	15	16	31	69	25	V1300	20L	50	
95	113-161	KRF95-12L	12	29	15	4,9	15	16	31	69	25	V1300	20L	50	
95	113-161	KRF95-16L	16	29	15	4,9	15	16	31	69	25	V1300	20L	50	
120	145-185	KRF120-8L	8	32	17	4,9	15	16	31	73	27	V1300	22L	25	
120	145-185	KRF120-10L	10	32	17	4,9	15	16	31	73	27	V1300	22L	25	
120	145-185	KRF120-12L	12	32	17	4,9	15	16	31	73	27	V1300	22L	25	
120	145-185	KRF120-16L	16	32	17	4,9	15	16	31	73	27	V1300	22L	25	
150	180-220	KRF150-00L		36	19	5,8			31	80	32	V1300, V250	25L	25	Unholed palm
150	180-220	KRF150-8L	8	36	19	5,8	15	16	31	80	32	V1300, V250	25L	25	
150	180-220	KRF150-10L	10	36	19	5,9	15	16	31	80	32	V1300, V250	25L	25	
150	180-220	KRF150-12L	12	36	19	5,9	15	16	31	80	32	V1300, V250	25L	25	
150	180-220	KRF150-16L	16	36	19	5,9	15	16	31	80	32	V1300, V250	25L	25	
185	220-265	KRF185-00L		39	21	5,9			38	93	37	V1300, V250	27L	20	Unholed palm
185	220-265	KRF185-10L	10	39	21	5,9	15	16	31	86	37	V1300, V250	27L	20	
185	220-265	KRF185-12L	12	39	21	5,9	15	16	31	86	37	V1300, V250	27L	20	
185	220-265	KRF185-16L	16	39	21	5,9	15	16	31	86	37	V1300, V250	27L	20	
185	220-265	KRF185-20L	20	39	21	5,9	19	19	38	93	37	V1300, V250	27L	20	
240	302-343	KRF240-00L		44	24	5,8			38	95	37	V1300, V250	30L	10	Unholed palm
240	302-343	KRF240-8L	8	44	24	5,9	19	19	38	95	37	V1300, V250	30L	10	
240	302-343	KRF240-10L	10	44	24	5,9	19	19	38	95	37	V1300, V250	30L	10	
240	302-343	KRF240-12L	12	44	24	5,9	19	19	38	95	37	V1300, V250	30L	10	
240	302-343	KRF240-16L	16	44	24	5,9	19	19	38	95	37	V1300, V250	30L	10	
300	340-400	KRF300-00L		46	24,5	6,8			54	116	44	V250	32L	10	Unholed palm
300	340-400	KRF300-10L	10	46	24,5	6,8	22	32	54	116	44	V250	32L	10	
300	340-400	KRF300-12L	12	46	24,5	6,8	22	32	54	116	44	V250	32L	10	
300	340-400	KRF300-16L	16	46	24,5	6,8	22	32	54	116	44	V250	32L	10	
300	340-400	KRF300-20L	20	46	24,5	6,8	22	32	54	116	44	V250	32L	10	
400	412-500	KRF400-00L		56	30	7,8			55	125	52	V250	38L	10	Unholed palm
400	412-500	KRF400-10L	10	56	30	7,8	22	33	55	125	52	V250	38L	10	
400	412-500	KRF400-12L	12	56	30	7,8	22	33	55	125	52	V250	38L	10	
400	412-500	KRF400-16L	16	56	30	7,8	22	33	55	125	52	V250	38L	10	
400	412-500	KRF400-20L	20	56	30	7,8	23	25	48	119	52	V250	38L	10	
500	500-580	KRF500-00L		61	33	8,8			70	160	70	V250	42L	5	Unholed palm
500	500-580	KRF500-12L	12	61	33	8,8	25	35	60	150	49	V250	42L	5	
500	500-580	KRF500-16L	16	61	33	8,8	25	35	60	150	68	V250	42L	5	
500	500-580	KRF500-20L	20	61	33	8,8	25	35	60	150	68	V250	42L	5	
630	630-730	KRF630-20L	20	73	39	10,8	25	35	60	175	80	V250	50L	5	
800		Contact Elpress for more information													

t = palm thickness, s = strip length

Tube terminals 90°, 25 - 400 mm²

- Material: Cu 99.95%, tin plated Cu/Sn.
- Cable inspection hole. For winding, flexible and stranded Cu-conductors.



Marking example KRF: 95 12F (Elpress logotype included) 20
 95 = mm², 12 = palm hole for M12, F = type KRF, 20 = Die No.

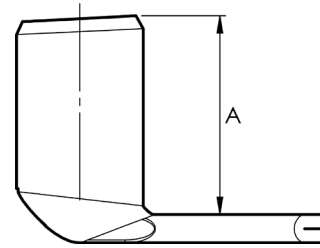
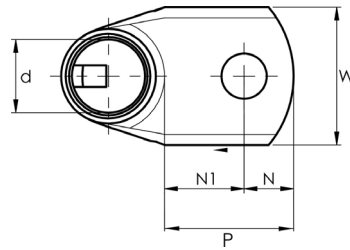

Conductor Cu mm ²	Winding mm ²	Name	Screw	W mm	d	N	N1	P	A	t	s	Tool	Die	Pcs/pack
25	30-47	KRF25-8L-90GR	8	16	8	8,5	12	20,5	18,5	2,9	13	V1300	11L	100
25	30-47	KRF25-10L-90GR	10	17	8	11,5	13,5	25	18,5	2,9	13	V1300	11L	100
35	45-70	KRF35-8L-90GR	8	18	9	8,5	12	20,5	22,5	3,9	16	V1300	13L	100
35	45-70	KRF35-10L-90GR	10	18	9	11,5	13,5	25	22,5	3,9	16	V1300	13L	100
35	45-70	KRF35-12L-90GR	12	19	9	12,5	17,5	30	22,5	3,7	16	V1300	13L	100
50	69-103	KRF50-8L-90GR	8	21	11	8,5	17,5	28	30,5	3,4	19	V1300	14,5L	100
50	69-103	KRF50-10L-90GR	10	21	11	11,5	18,5	30	30,5	3,4	19	V1300	14,5L	100
50	69-103	KRF50-12L-90GR	12	21	11	12,5	19,5	32	30,5	3,4	19	V1300	14,5L	100
70	100-120	KRF70-8L-90GR	8	24	13	8,5	17,5	26	31,5	3,9	22	V1300	17L	50
70	100-120	KRF70-12L-90GR	12	24	13	12,5	19,5	32	31,5	3,9	22	V1300	17L	50
70	100-120	KRF70-10L-90GR	10	24	13	11,5	18,5	30	31,5	3,9	22	V1300	17L	50
95	113-161	KRF95-8L-90GR	8	28	15	8,5	17,5	26	32,5	4,9	25	V1300	20L	50
95	113-161	KRF95-10L-90GR	10	28	15	11,5	18,5	30	32,5	4,9	25	V1300	20L	50
95	113-161	KRF95-12L-90GR	12	28	15	12,5	19,5	32	32,5	4,9	25	V1300	20L	50
95	113-161	KRF95-16L-90GR	16	29	15	15,5	20,5	36	32,5	4,9	25	V1300	20L	50
120	145-185	KRF120-10L-90GR	10	32	17	11,5	18,5	30	42	4,9	27	V1300	22L	25
120	145-185	KRF120-12L-90GR	12	32	17	12,5	19,5	32	42	4,9	27	V1300	22L	25
120	145-185	KRF120-16L-90GR	16	32	17	15,5	20,5	36	42	4,9	27	V1300	22L	25
150	180-220	KRF150-10L-90GR	10	36	19	11,5	18,5	30	47	5,9	27	V1300, V250	25L	25
150	180-220	KRF150-12L-90GR	12	36	19	12,5	19,5	32	47	5,9	27	V1300, V250	25L	25
150	180-220	KRF150-16L-90GR	16	36	19	15,5	20,5	36	47	5,9	32	V1300, V250	25L	25
185	220-265	KRF185-10L-90GR	10	39	21	11,5	18,5	30	42,5	5,8	37	V1300, V250	27L	25
185	220-265	KRF185-12L-90GR	12	39	21	12,5	19,5	32	42,5	5,8	37	V1300, V250	27L	20
240	302-343	KRF240-10L-90GR	10	44	24	11,5	18,5	30	47	5,9	37	V1300, V250	30L	15
240	302-343	KRF240-12L-90GR	12	44	24	12,5	19,5	32	47	5,9	37	V1300, V250	30L	15
300	340-400	KRF300-12L-90GR	12	46	24,5	15	25	40	57	6,9	44	V250	32L	10
300	340-400	KRF300-16L-90GR	16	46	24,5	20	25	45	57	6,9	44	V250	32L	10
400	412-500	KRF400-12L-90GR	12	56	30	22	33	55	64,2	7,8	52	V250	38L	5
400	412-500	KRF400-16L-90GR	16	56	30	22	33	55	64,2	7,8	52	V250	38L	5

t = palm thickness, s = strip length

Tube terminals 45°, 25 - 400 mm²

- Material: Cu 99.95%, tin plated Cu/Sn.
- Cable inspection hole. For winding, flexible and stranded Cu-conductors.



Marking example KRF: 95 12F (Elpress logotype included) 20
 95 = mm² 12 = palm hole for M12 F = type KRF, 20 = Die No.

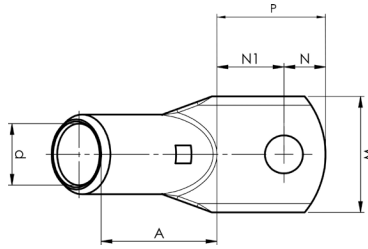

Conductor Cu mm ²	Winding mm ²	Name	Screw	W mm	d	N	N1	P	A	t	s	Tool	Die	Pcs/pack
25	30-47	KRF25-8L-45GR	8	16	8	8,5	12,2	20,7	23	2,9	13	V1300	11L	100
25	30-47	KRF25-10L-45GR	10	17	8	11,5	13,7	25,2	23	2,9	13	V1300	11L	100
35	45-70	KRF35-8L-45GR	8	18	9	8,5	12	20,5	30	3,9	16	V1300	13L	100
35	45-70	KRF35-10L-45GR	10	18	9	11,5	13,5	25	30	3,9	16	V1300	13L	100
35	45-70	KRF35-12L-45GR	12	19	9	12,5	17,5	30	30	3,7	16	V1300	13L	100
50	69-103	KRF50-8L-45GR	8	21	11	8,5	17,5	26	31	3,4	19	V1300	14,5L	100
50	69-103	KRF50-10L-45GR	10	21	11	11,5	18,5	30	31	3,4	19	V1300	14,5L	100
50	69-103	KRF50-12L-45GR	12	21	11	12,5	19,5	32	31	3,4	19	V1300	14,5L	100
70	100-120	KRF70-10L-45GR	10	25	13	11,5	18,5	30	35	3,9	22	V1300	17L	50
70	100-120	KRF70-12L-45GR	12	24	13	12,5	19,5	32	35	3,9	22	V1300	17L	50
95	113-161	KRF95-10L-45GR	10	28	15	11,5	18,5	30	40	4,9	25	V1300	20L	50
95	113-161	KRF95-12L-45GR	12	29	15	12,5	19,5	32	40	4,9	25	V1300	20L	50
120	145-185	KRF120-10L-45GR	10	32	17	11,5	18,5	30	43	4,9	27	V1300	22L	25
120	145-185	KRF120-12L-45GR	12	32	17	12,5	19,5	32	43	4,9	27	V1300	22L	25
150	180-220	KRF150-10L-45GR	10	36	19	11,5	18,5	30	49	5,9	32	V1300, V250	25L	25
150	180-220	KRF150-12L-45GR	12	36	19	12,5	19,5	32	49	5,9	32	V1300, V250	25L	25
185	220-265	KRF185-10L-45GR	10	39	21	11,5	18,5	30	55	5,8	37	V1300, V250	27L	20
185	220-265	KRF185-12L-45GR	12	39	21	12,5	19,5	32	55	5,8	37	V1300, V250	27L	20
240	302-343	KRF240-10L-45GR	10	44	24	11,5	18,5	30	57	5,8	37	V1300, V250	30L	10
240	302-343	KRF240-12L-45GR	12	44	24	12,5	19,5	32	57	5,8	37	V1300, V250	30L	10
300	340-400	KRF300-12L-45GR	12	46	24,5	22	18	40	61	6,8	44	V250	32L	10
300	340-400	KRF300-16L-45GR	16	46	24,5	22	18	40	61	6,8	44	V250	32L	10
400	412-500	KRF400-12L-45GR	12	56	30	22	18	40	75	7,8	52	V250	38L	8

t = palm thickness, s = strip length

Tube terminals with two stud holes 50 - 630 mm²

- Material: Cu 99.95%, tin plated Cu/Sn.
- Cable inspection hole. For winding, flexible and stranded Cu-conductors.



Marking example KRF: 95 12F (Elpress logotype included) 20
 95 = mm² 12 = palm hole for M12 F = type KRF, 20 = Die No.

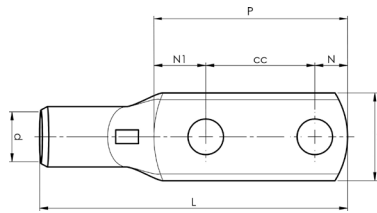

mm ²	Winding mm ²	Name	Screw	W mm	d	N	N1	P	cc	L	t	s	Tool	Die	Pcs/pack
50	69-103	KRF50-12X2-44,5L	12x2	21	11	12	18,5	75	44,5	105	3,4	19	V1300	14,5L	50
70	100-120	KRF70-12X2-44,5L	12x2	25	13	12	17,5	74	44,5	107	3,9	22	V1300	17L	25
95	113-161	KRF95-12X2-40L	12x2	29	15	12	18	70	40	109	4,9	25	V1300	20L	25
95	113-161	KRF95-12X2-44,5L	12x2	29	15	12	18,5	75	44,5	113	4,9	25	V1300	20L	25
120	145-185	KRF120-12X2-40L	12x2	32	17	12	19	71	40	113	4,9	27	V1300	22L	25
120	145-185	KRF120-12X2-44,5L	12x2	32	17	12	17,5	74	44,5	116	4,9	27	V1300	22L	25
150	180-220	KRF150-12X2-40L	12x2	36	19	12	19	71	40	120	5,9	32	V1300, V250	25L	20
150	180-220	KRF150-12X2-44,5L	12x2	36	19	12	18,5	75	44,5	123	5,9	32	V1300, V250	25L	20
185	220-265	KRF185-12X2-40L	12x2	39	21	12	20	72	40	126	5,9	37	V1300, V250	27L	20
185	220-265	KRF185-12X2-44,5L	12x2	39	21	12	19,5	76	44,5	130	5,9	37	V1300, V250	27L	10
240	302-343	KRF240-12X2-40L	12x2	44	24	12	21	73	40	129	5,9	37	V1300, V250	30L	10
240	302-343	KRF240-12X2-44,5L	12x2	44	24	12	19,5	76	44,5	132	5,9	37	V1300, V250	30L	10
300	340-400	KRF300-12X2-40L	12x2	45	24,5	12	22	74	40	136	6,8	44	V250	32L	10
300	340-400	KRF300-12X2-44,5L	12x2	46	24,5	12	20,5	77	44,5	139	6,8	44	V250	32L	10
400	412-500	KRF400-12X2-40L	12x2	56	30	12	23	75	40	145	7,8	52	V250	38L	5
400	412-500	KRF400-12X2-44,5L	12x2	56	30	12	20,5	77	44,5	147	7,8	52	V250	38L	5
500	500-580	KRF500-12X2-40L	12x2	61	33	15	15	70	40	160	8,8	70	V250	42L	5
500	500-580	KRF500-12X2-44,5L	12x2	61	33	12	18,5	75	44,5	165	8,8	70	V250	42L	5
630	630-730	KRF630-12X2-44,5L	12x2	73	39	15	20,5	80	44,5	195	10,8	80	V250	50L	
800	Contact Elpress for more information														

t = palm thickness, s = strip length

Tube terminals with two stud holes (one oval) 50 - 240 mm²

- Material: Cu 99.95%, tin plated Cu/Sn.
- Cable inspection hole. For winding, flexible and stranded Cu-conductors.
- With an oval hole nearest the tube.



Marking example KRF: 95 12F (Elpress logotype included) 20
 95 = mm² 12 = palm hole for M12 F = type KRF, 20 = Die No.

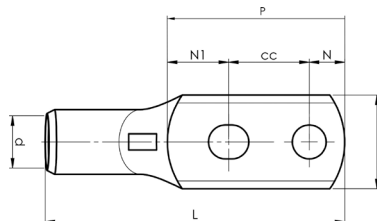

Conductor Cu mm ²	Winding mm ²	Name	Screw	W mm	d	N	N1	P	cc	L	t	s	Tool	Die	Pcs/pack
50	69-103	KRF50-10X2-24-26L	10x2	21	11	11	22	58	25	87	3,4	19	V1300	14,5L	50
70	100-120	KRF70-10X2-24-26L	10x2	25	13	11	17	53	25	86	3,9	22	V1300	17L	50
95	113-161	KRF95-10X2-24-26L	10x2	29	15	11	19	55	25	93	4,9	25	V1300	20L	25
120	145-185	KRF120-10X2-24-26L	10x2	32	17	11	19	55	25	97	4,9	27	V1300	22L	25
150	180-220	KRF150-10X2-24-26L	10x2	36	19	11	19	55	25	104	5,9	32	V1300, V250	25L	25
185	220-265	KRF185-10X2-24-26L	10x2	39	21	11	21	57	25	111	5,9	37	V1300, V250	27L	20
240	302-343	KRF240-10X2-24-26L	10x2	44	24	11	22	58	25	114	5,9	37	V1300, V250	30L	10

t = palm thickness, s = strip length

Tube terminals 90° with two stud holes 150 - 630 mm²

- Material: Cu 99.95%, tin plated Cu/Sn.
- Cable inspection hole.
- For winding, flexible and stranded Cu-conductors.



Marking example KRF: 150 12F (Elpress logotype included) 25
 150 = mm² 12 = palm hole for M12 F = type KRF 25 = Die No.

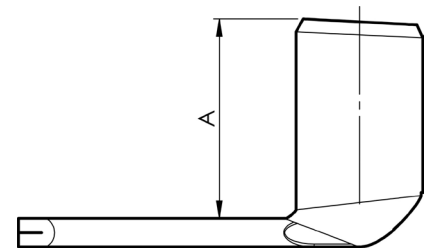
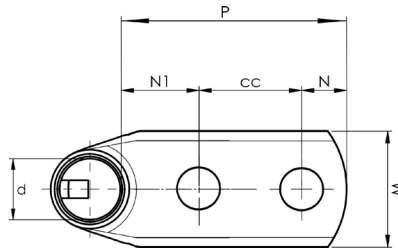

Conductor Cu mm ²	Winding mm ²	Name	Screw	W mm	d	N	N1	P	cc	A	t	s	Tool	Die	Pcs/pack
150	180-220	KRF150-12X2-40L-90GR	12x2	36	19	12	15	67	40	46,1	5,9	32	V1300, V250	25L	20
150	180-220	KRF150-12X2-44,5L-90GR	12x2	36	19	12	16,5	73	44,5	50	5,9	32	V1300, V250	25L	25
240	302-343	KRF240-12X2-40L-90GR	12x2	44	24	12	22	74	40	57,1	5,9	37	V1300, V250	30L	10
240	302-343	KRF240-12X2-44,5L-90GR	12x2	44	24	12	15,5	72	44,5	57,1	5,8	37	V1300, V250	30L	15
300	340-400	KRF300-12X2-40L-90GR	12x2	46	24,5	12	22	74	40	70	6,8	44	V250	32L	10
400	412-500	KRF400-12X2-44,5L-90GR	12x2	56	30	12	23,5	80	44,5	70	7,8	52	V250	38L	5
500	500-580	KRF500-12X2-44,5L-90GR	12x2	61	33	15	20,5	80	44,5	86	8,8	70	V250	42L	4
630	630-730	KRF630-12X2-44,5L-90GR	12x2	73	39	15	17,5	80	44,5	112	10,8	80	V250	50L	1

t = palm thickness, s = strip length

Tube terminals 90° with two stud holes (one oval) 70 - 240 mm²

- Material: Cu 99.95%, tin plated Cu/Sn.
- Cable inspection hole.
- For winding, flexible and stranded Cu-conductors.
- With an oval hole nearest the tube.



Marking example KRF: 150 12F (Elpress logotype included) 25
 150 = mm² 12 = palm hole for M12 F = type KRF 25 = Die No.

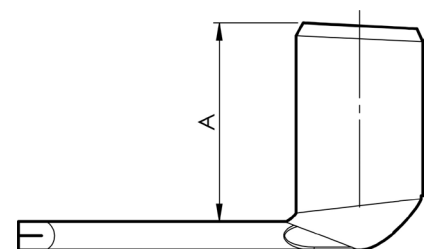
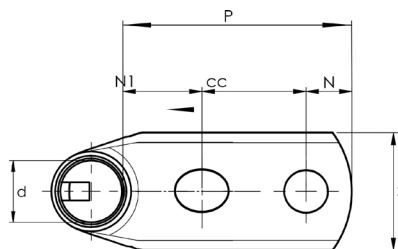

Conductor Cu mm ²	Winding mm ²	Name	Screw	W mm	d	N	N1	P	cc	A	t	s	Tool	Die	Pcs/pack
70	100-120	KRF70-10X2-24-26L-90GR	10x2	25	13	11	16	51	24	30,1	3,9	22	V1300	17L	50
150	180-220	KRF150-10X2-24-26L-90GR	10x2	36	19	11	18	53	24	48,1	5,9	32	V1300, V250	25L	20
240	302-343	KRF240-10X2-24-26L-90GR	10x2	44	24	11	19	56	24	57,1	5,9	37	V1300, V250	30L	10

t = palm thickness, s = strip length

Through connectors 16 - 630 mm²

- Material: Cu 99.95%, tin plated Cu/Sn.
- Cable inspection hole and cable stop.
- For winding, flexible and stranded Cu-conductors.



Marking example: 20 95F (earth-sign) Elpress logotype included
 20 = die no. 95 = mm² F = type KSF

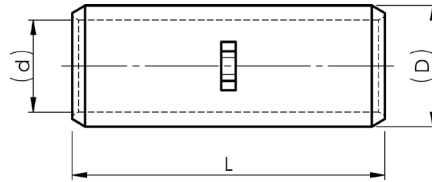

Conductor Cu mm ²	Winding mm ²	Name	d mm	D	L	s	Tool	Die	Pcs/pack	Note
16	14-22	KSF16L	6	9	35	11	V1300	9L	100	
25	30-47	KSF25L	8	11	35	13	V1300	11L	100	
35	45-70	KSF35L	9	13	35	17	V1300	13L	100	
50	69-103	KSF50L	11	14,5	45	22	V1300	14,5L	50	
70	100-120	KSF70L	13	17	45	22	V1300	17L	50	
95	113-161	KSF95L	15	20	45	25	V1300	20L	50	
120	145-185	KSF120L	17	22	55	27	V1300	22L	50	
150	180-220	KSF150L	19	25	65	32	V1300, V250	25L	25	
185	220-265	KSF185L	21	27	70	35	V1300, V250	27L	25	
240	302-343	KSF240L	24	30	70	35	V1300, V250	30L	25	
300	340-400	KSF300L	24,5	31,5	75	37	V250	32L	10	
400	412-500	KSF400L	30	38	100	50	V250	38L	10	
500	500-580	KSF500L	33	42	135	68	V250	42L	5	
630	630-730	KSF630L	39	50	170	80	V250	50L	2	
800	<i>Contact Elpress for more information</i>									

s = strip length

Reducer through connectors 35 - 630 mm²

• Material: Cu 99.95%, tin plated Cu/Sn.
For winding, flexible and stranded Cu-conductors.



Marking example: 25-150F 20-95F Elpress logotype included
25 / 20 = Die No. 150, 95 = mm² F = type KSF

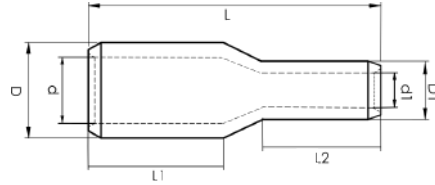

Conductor Cu mm ²	Winding mm ²	Name	D mm	d	D1	d1	L	L1	L2	s	s1	Tool	Die	Die (Smaller area)	Pcs/ pack
35-16	45-70/14-22	KSF35-16L	13	9	9	6	32	16,8	13	18		V1300	13L	9L	100
35-25	45-70/30-47	KSF35-25L	13	9	11	8	33	16	14	18	16	V600, V1300	13L	11L	100
50-25	69-103/30-47	KSF50-25L	14,5	11	11	8	40	20,4	16	22	18	V600, V1300	14,5L	11L	50
50-35	69-103/45-70	KSF50-35L	14,5	11	13	9	55	24,1	25	26	27	V600, V1300	14,5L	13L	50
70-25	100-120/30-47	KSF70-25L	17	13	11	8	46	24,5	16	26		V600, V1300	17L	11L	50
70-35	100-120/45-70	KSF70-35L	17	12,9	13	9	60	24,2	25	26	27	V600, V1300	17L	13L	50
70-50	100-120/69-103	KSF70-50L	17	13	14,5	11	50	24,2	20	26	22	V600, V1300	17L	14,5L	50
95-25	113-161/30-47	KSF95-25L	20	15	11	8	52	26,1	18	27	16	V600, V1300	20L	11L	25
95-35	113-161/45-70	KSF95-35L	20	15	13	9	60	25,4	25	27	27	V600, V1300	20L	13L	25
95-50	113-161/69-103	KSF95-50L	20	15	14,5	11	55	25,3	20	27	22	V600, V1300	20L	14,5L	25
95-70	113-161/100-120	KSF95-70L	20	15	17	13	60	25,2	25	27	27	V600, V1300	20L	17L	25
120-35	145-185/45-70	KSF120-35L	22	17	13	9	65	31,6	25	33	27	V600, V1300	22L	13L	25
120-50	145-185/69-103	KSF120-50L	22	17	14,5	11	60	31,5	20	33	22	V600, V1300	22L	14,5L	50
120-70	145-185/100-120	KSF120-70L	22	17	17	13	65	31,3	25	33	27	V600, V1300	22L	17L	25
120-95	145-185/113-161	KSF120-95L	22	17	20	15	70	31,2	31	33	33	V600, V1300	22L	20L	25
150-35	180-220/45-70	KSF150-35L	25	19	13	9	65	32	25	33	27	V1300	25L	13L	25
150-50	180-220/69-103	KSF150-50L	25	19	14,5	11	60	31,9	20	33	22	V1300	25L	14,5L	25
150-70	180-220/100-120	KSF150-70L	25	19	17	13	65	31,7	25	33	27	V1300	25L	17L	25
150-95	180-220/113-161	KSF150-95L	25	19	20	15	70	31,5	31	33	33	V1300	25L	20L	25
150-120	180-220/145-185	KSF150-120L	25	19	22	17	70	31,3	31	33	33	V1300	25L	22L	25
185-35	220-265/45-70	KSF185-35L	27	21	13	9	65	32,2	25	33	27	V1300	27L	13L	25
185-50	220-265/69-103	KSF185-50L	27	21	14,5	11	65	32,1	25	33	27	V1300	27L	14,5L	25
185-70	220-265/100-120	KSF185-70L	27	21	17	13	65	31,8	25	33	27	V1300	27L	17L	25
185-95	220-265/113-161	KSF185-95L	27	21	20	15	71	31,6	31	33	33	V1300	27L	20L	25
185-120	220-265/145-185	KSF185-120L	27	21	22	17	70	31,5	31	33	33	V1300	27L	22L	25
185-150	220-265/180-220	KSF185-150L	27	21	25	19	71	31,1	31	33	33	V1300, V250	27L	25L	25
240-35	302-343/45-70	KSF240-35L	30	24	13	9	65	32,3	25	33	27	V1300	30L	13L	25
240-50	302-343/69-103	KSF240-50L	30	24	14,5	11	70	32,2	30	33	32	V1300	30L	14,5L	25
240-70	302-343/100-120	KSF240-70L	30	24	17	13	65	33,5	25	33	27	V1300	30L	17L	25
240-95	302-343/113-161	KSF240-95L	30	24	20	15	71	31,8	31	33	33	V1300	30L	20L	25
240-120	302-343/145-185	KSF240-120L	30	24	22	17	70	31,8	31	33	33	V1300	30L	22L	25
240-150	302-343/180-220	KSF240-150L	30	24	25	19	70	31	31	33	33	V1300, V250	30L	25L	25
240-185	302-343/220-265	KSF240-185L	30	24	27	21	70	31,3	31	33	33	V1300, V250	30L	27L	25
300-70	340-400/100-120	KSF300-70L	31,5	24,5	17	13	70	36,1	24	37	26	V250, V1300	32L	17L	25
300-95	340-400/113-161	KSF300-95L	31,5	24,5	20	15	77	35,9	31	37	33	V250, V1300	32L	20L	25
300-120	340-400/145-185	KSF300-120L	31,5	24,5	22	17	76	35,9	31	37	33	V1300, V250	32L	22L	25
300-150	340-400/180-220	KSF300-150L	31,5	24,5	25	19	76	35,6	31	37	33	V250	32L	25L	10
300-185	340-400/220-265	KSF300-185L	31,5	24,5	27	21	76	35,4	31	37	33	V250	32L	27L	20
300-240	340-400/302-343	KSF300-240L	31,5	24,5	30	24	76	35,1	31	37	33	V250	32L	30L	20
400-35	412-500/45-70	KSF400-35L	38	30	13	9	82	47	25	47	27	V250, V1300	38L	13L	10
400-95	412-500/113-161	KSF400-95L	38	30	20	15	90	45	31	47	33	V1300, V250	38L	20L	10
400-120	412-500/145-185	KSF400-120L	38	30	22	17	90	45	31	47	33	V250, V1300	38L	22L	5
400-150	412-500/180-220	KSF400-150L	38	30	25	19	90	45	31	47	33	V250	38L	25L	10
400-185	412-500/220-265	KSF400-185L	38	30	27	21	90	45	31	47	33	V250	38L	27L	5
400-240	412-500/302-343	KSF400-240L	38	30	30	24	90	45	31	47	33	V1300, V250	38L	30L	10
400-300	412-500/340-400	KSF400-300L	38	30	31,5	24,5	90	45	35	47	37	V250	38L	32L	10
500-95	500-580/113-161	KSF500-95L	42	33	20	15	101	47	31	49	27	V250, V1300	42L	20L	10
500-120	500-580/145-185	KSF500-120L	42	33	22	17	101	47	31	49	33	V250, V1300	42L	22L	10
500-150	500-580/180-220	KSF500-150L	42	33	25	19	101	47	31	49	33	V250	42L	25L	10
500-185	500-580/220-265	KSF500-185L	42	33	27	21	101	47	31	49	33	V250	42L	27L	5
500-240	500-580/302-343	KSF500-240L	42	33	30	24	101	47	31	49	33	V250	42L	30L	5
500-300	500-580/340-400	KSF500-300L	42	33	31,5	24,5	105	47	35	49	37	V250	42L	32L	5
500-400	500-580/412-500	KSF500-400L	42	33	38	30	115	47	45	49	47	V250	42L	38L	5
630-240	630-730/302-343	KSF630-240L	50	39	30	24	111	60	35	62	37	V250	50L	30L	5
630-300	630-730/340-400	KSF630-300L	50	39	31,5	24,5	111	60	35	62	37	V250	50L	32L	5
630-400	630-730/412-500	KSF630-400L	50	39	38	30	121	60	45	62	47	V250	50L	38L	5
630-500	630-730/500-580	KSF630-500L	50	39	42	33	126	60	50	62	52	V250	50L	42L	4

s, s1 = insulation stripping length

Parallel through connectors, winding to flexible conductor 50-400 mm²

- Material: Cu 99,95%, tin plated Cu/Sn.
- For combination of copper winding and flexible or stranded conductors.



Marking example: 120 P22L Elpress logotype included
 120 = mm² P22L = die no.

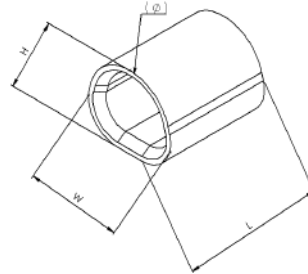
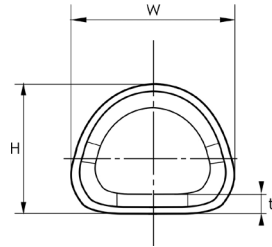

Flexible conductor mm ²	Winding conductor mm ²	Working area mm ²	Name	W mm	Ø	H	L	t	Tool	Pcs/pack	Punch	Matrix
25	9-37	34-62	KS50PL	15,2	14,5	12,5	30	1,8	V1300/V1300L	100	13P14,5DL	13P14,5ML
35	31-52	66-87	KS70PL	17,7	17	15	30	2	V1300/V1300L	50	13P17DL	13P17ML
50	38-62	88-112	KS95PL	21,1	20	18	30	2,5	V1300/V1300L	100	13P20PDL	13P20ML
50	63-90	113-140	KS120PL	22,7	22	20	32	2,5	V1300/V1300L	50	13P22DL	13P22ML
70	43-70	113-140	KS120PL	22,7	22	20	32	2,5	V1300/V1300L	50	13P22DL	13P22ML
70	71-105	141-175	KS150PL	25,4	25	23	34	3	V1300/V1300L	50	13P25DL	13P25ML
95	81-120	176-215	KS185PL	27,4	27	25	36	3	V1300/V1300L	25	13P27DL	13P27DL
120	96-160	216-280	KS240PL	30,7	30	28	38	3	V1300/V1300L	25	13P30DL	13P30ML
150	136-170	286-320	KS300PL	36,4	32	30	35	3	V250/V250L	25	P2532DL	P2532ML
185	170-255	355-440	KS400PL	43,2	38	34	50	4	V250/V250L	10	P2538DL	P2538ML

T-connectors with different area 25 - 500 mm² KTSF

- Material: Cu 99.95%, tin plated Cu/Sn.
- Cable inspection hole.
- For winding, flexible and stranded Cu-conductors.



Marking example: Elpress Logotype

20 = Elpress Die no. 20 2x95F = 2 entries 95 mm²

F = KSF (Flexible, Stranded or Winding Conductors)

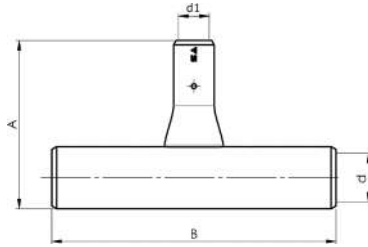

Conductor Cu mm ²	Winding mm ²	Name	d mm	d1	A	B	Die (Branch conductor)	Die (through conductor)	Tools	Pcs/pack
25-50	30-47, 69-103	KTSF25-50	8	11	69,5	80	11L	14,5L	V600, V1300	20
50-150	69-103, 180-220	KTSF50-150	11	19	91	110	14,5L	25L	V1300, V250	5
70-95	100-120, 113-161	KTSF70-95	13	15	77	100	17L	20L	V600, V1300	10
70-120	100-120, 145-185	KTSF70-120	13	17	87	110	17L	22L	V600, V1300	5
70-150	100-120, 180-220	KTSF70-150	13	19	91	110	17L	25L	V1300, V250	5
70-240	100-120, 302-343	KTSF70-240	13	24	89	120	17L	30L	V1300, V250	5
95-35	113-161, 45-70	KTSF95-35	15	9	70	93	20L	13L	V600, V1300	10
95-50	113-161, 69-103	KTSF95-50	15	11	75	96	20L	14,5L	V600, V1300	10
95-150	113-161, 180-220	KTSF95-150	15	19	92	110	20L	25L	V1300, V250	5
95-240	113-161, 302-343	KTSF95-240	15	24	90	120	20L	30L	V1300, V250	5
120-150	145-185, 180-220	KTSF120-150	17	19	92	120	22L	25L	V1300, V250	5
120-185	145-185, 220-265	KTSF120-185	17	21	96	120	22L	27L	V1300, V250	5
150-50	180-220, 69-103	KTSF150-50	19	11	80	124	25L	14,5L	V1300, V250	10
150-95	180-220, 113-161	KTSF150-95	19	15	83	124	25L	20L	V1300, V250	8
185-35	220-265, 45-70	KTSF185-35	21	9	80	105	27L	13L	V1300, V250	6
185-50	220-265, 69-103	KTSF185-50	21	11	85	105	27L	14,5L	V1300, V250	6
185-95	220-265, 113-161	KTSF185-95	21	15	88	110	27L	20L	V1300, V250	6
185-150	220-265, 180-220	KTSF185-150	21	19	97	124	27L	25L	V1300, V250	6
240-35	302-343, 45-70	KTSF240-35	24	9	80	105	30L	13L	V1300, V250	5
240-50	302-343, 69-103	KTSF240-50	24	11	85	129	30L	14,5L	V1300, V250	6
240-95	302-343, 113-161	KTSF240-95	24	15	88	129	30L	20L	V1300, V250	6
240-120	302-343, 145-185	KTSF240-120	24	17	89	129	30L	22L	V1300, V250	5
240-150	302-343, 180-220	KTSF240-150	24	19	97	129	30L	25L	V1300, V250	5
240-185	302-343, 220-265	KTSF240-185	24	21	99	129	30L	27L	V1300, V250	4
240-400	302-343, 412-500	KTSF240-400	24	30	129	154	30L	38L	V1300, V250	2
300-150	340-400, 180-220	KTSF300-150	24,5	19	98	130	32L	25L	V1300, V250	4
400-35	412-500, 45-70	KTSF400-35	30	9	92	160	38L	13L	V250	4
400-50	412-500, 69-103	KTSF400-50	30	11	97	160	38L	14,5L	V250	4
400-95	412-500, 113-161	KTSF400-95	30	15	99	170	38L	20L	V250	4
400-150	412-500, 180-220	KTSF400-150	30	19	103	175	38L	25L	V250	2
400-185	412-500, 220-265	KTSF400-185	30	21	111	180	38L	27L	V250	2
400-240	412-500, 302-343	KTSF400-240	30	24	112	190	38L	30L	V250	2
400-300	412-500, 340-400	KTSF400-300	30	24,5	108	190	38L	32L	V250	2
500-35	500-580, 45-70	KTSF500-35	33	9	92	160	42L	13L	V250	2
500-50	500-580, 69-103	KTSF500-50	33	11	97	160	42L	14,5L	V250	2
500-95	500-580, 113-161	KTSF500-95	33	15	100	170	42L	20L	V250	2
500-150	500-580, 180-220	KTSF500-150	33	19	107	180	42L	25L	V250	2
500-185	500-580, 220-265	KTSF500-185	33	21	111	180	42L	27L	V250	2
500-240	500-580, 302-343	KTSF500-240	33	24	112	200	42L	30L	V250	2
500-300	500-580, 340-400	KTSF500-300	33	24,5	113	200	42L	32L	V250	2
500-400	500-580, 412-500	KTSF500-400	33	30	135	200	42L	38L	V250	2

T-connectors 110°, 35 - 400 mm² KTSF

- Material: Cu 99.95%, tin plated Cu/Sn.
- Cable inspection hole.
- For winding, flexible and stranded Cu-conductors.



Marking example: 14,5 3x50F Eipress logotype included
 14,5 = die no. 3x = no. of conductor entries 50 = mm² F = type KSF

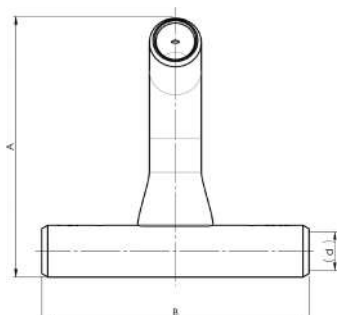

Conductor Cu mm ²	Winding mm ²	Name	d mm	A	B	Die	Tools	Pcs/ pack
35	45-70	KTSF35-110GR	9	63	87	13L	V600, V1300	20
50	69-103	KTSF50-110GR	11	66	96	14,5L	V600, V1300	20
70	100-120	KTSF70-110GR	13	80	100	17L	V600, V1300	10
95	113-161	KTSF95-110GR	15	84,5	103	20L	V600, V1300	6
120	145-185	KTSF120-110GR	17	91	120	22L	V600, V1300	6
150	180-220	KTSF150-110GR	19	104	124	25L	V1300, V250	4
185	220-265	KTSF185-110GR	21	112	124	27L	V1300, V250	2
240	302-343	KTSF240-110GR	24	116	129	30L	V1300, V250	2
300	340-400	KTSF300-110GR	24,5	119	130	32L	V1300, V250	2
400	412-500	KTSF400-110GR	30	177	190	38L	V250	3

T-connectors 35 - 630 mm² KTSF

- Material: Cu 99.95%, tin plated Cu/Sn.
- Cable inspection hole. For Cu-conductors; flexible, stranded and winding.



Marking example: 14,5 3x50F Eipress logotype included
 14,5 = die no. 3x = no. of conductor entries 50 = mm²
 F = type KSF, flexible, stranded and winding conductors

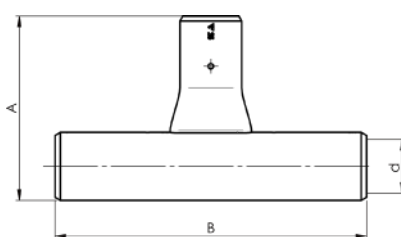

Conductor Cu mm ²	Winding mm ²	Name	d mm	A	B	Die	Tools	Pcs/ pack
35	45-70	KTSF35	9	63	87	13L	V600, V1300	20
50	69-103	KTSF50	11	70	96	14,5L	V600, V1300	20
70	100-120	KTSF70	13	74	100	17L	V600, V1300	10
95	113-161	KTSF95	15	77	103	20L	V600, V1300	10
120	145-185	KTSF120	17	87,5	120	22L	V600, V1300	6
150	180-220	KTSF150	19	92	124	25L	V1300, V250	6
185	220-265	KTSF185	21	96	124	27L	V1300, V250	6
240	302-343	KTSF240	24	100	129	30L	V1300, V250	4
300	340-400	KTSF300	24,5	101,5	130	32L	V1300, V250	4
400	412-500	KTSF400	30	130	190	38L	V250	2
500	500-580	KTSF500	33	134,5	200	42L	V250	2
630	630-730	KTSF630	39	168	235	50L	V250	2

Tube terminals 0,75 - 10 mm² KR

- Material: Cu 99.95%, tin plated Cu/Sn.
- For stranded (class 2) up to multi stranded (class 6) Cu-conductors, according to IEC 60228.
- UL approved (1.5 - 10 mm²).



Marking example KR: 10 10
10 = mm² 10 = Plate hole for M10

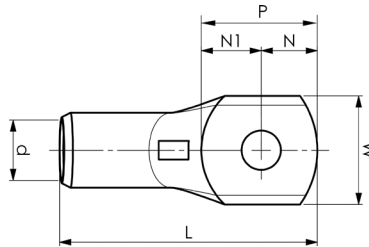

mm ²	Name	Screw	W mm	d	t	N	N1	L	s	P	Tool	Inspection hole	Die	Pcs/pack
0,75	KR0,75-3	3	6	1,3	0,85	3,2	3,8	16	7,5	7	DKB0325, DKB0760			100
0,75	KR0,75-4	4	6	1,3	0,8	3,2	3,5	17	7,5	6,7	DKB0325, DKB0760			100
1,5	KR1,5-3	3	6,5	1,8	1	3,4	3,6	16	7,5	7	DKB0325, DKB0760			100
1,5	KR1,5-4	4	6,5	1,8	0,9	4,2	3,8	17	7,5	8	DKB0325, DKB0760			100
1,5	KR1,5-5	5	7,5	1,8	0,85	4,8	4,7	18	7,5	9,5	DKB0325, DKB0760			100
2,5	KR2,5-3	3	7,5	2,3	1,3	3,5	4,1	17	7	7,6	DKB0325, DKB0760			100
2,5	KR2,5-4	4	7,5	2,3	1,3	4,2	4,1	18	7	8,3	DKB0325, DKB0760			100
2,5	KR2,5-5	5	8,5	2,3	1,1	4,8	4,8	19	7	9,6	DKB0325, DKB0760			100
2,5	KR2,5-6	6	8,5	2,4	1,1	5,1	5,8	19	7	10,9	DKB0325, DKB0760			100
4	KR4-4	4	8,5	3	1,5	4,2	5,8	22	8,5	10	GWB4099, ES2258			100
4	KR4-5	5	9	3	1,5	4,8	5,2	22	8,5	10	GWB4099, ES2258			100
4	KR4-6	6	9,9	3	1,3	5	7	23	8,5	12	GWB4099, ES2258			100
6	KR6-4	4	9,5	4	1,7	4	6	22	8,5	10	GWB4099, ES2258			100
6	KR6-5	5	9,5	4	1,7	5	6	22	8,5	11	GWB4099, ES2258			100
6	KR6-6	6	9,9	4	1,6	5,5	6,5	23	8,5	12	GWB4099, ES2258			100
6	KR6-8	8	13	4	1,2	7	10	30	8,5	17	GWB4099, ES2258			100
10	KR10-5	5	11,5	5	2,9	6	7,5	29	11	13,5	GWB4099, PVL350, V600, V1300, V250		8	100
10	KR10-6	6	11,5	5	3	6	7,5	29	11	13,5	GWB4099, PVL350, V600, V1300, V250	Yes	8	100
10	KR10-8	8	13,5	5	2,3	7,5	8,5	33	11	16	GWB4099, PVL350, V600, V1300, V250	Yes	8	100
10	KR10-10	10	16	5	2	8	10	34	11	18	GWB4099, PVL350, V600, V1300, V250	Yes	8	100
10	KR10-12	12	18,5	5	1,7	10	13,5	41	11	23,5	GWB4099, PVL350, V600, V1300, V250	Yes	8	100

t = plate thickness, s = strip length

Through connectors 0,75 - 10 mm² KS

- Material: Cu 99.95%, tin plated Cu/Sn.
- Cable inspection hole and cable stop.
- For stranded (class 2) up to multi stranded (class 6) Cu-conductors, according to IEC 60228.
- UL approved (1.5 - 10 mm²).



Marking example: 8 10 Elpress logotype included
8 = die no. 10 = mm²

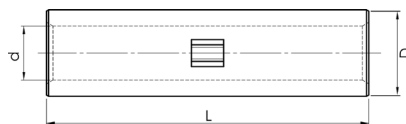

mm ²	Name	d mm	D	L	s	Tool	Die	Pcs/pack
0,75	KS0,75	1,3	2,8	14	7	DKB0325, DKB0760		100
1,5	KS1,5	1,8	3,3	14	7	DKB0325, DKB0760		100
2,5	KS2,5	2,3	4,2	16	8	DKB0325, DKB0760		100
4	KS4	3	5	19	9	GWB4099, ES2258		100
6	KS6	4	6	19	9	GWB4099, ES2258		100
10	KS10	5	8	30	15	PVL350, V600, V1300, V250	8	100

s = strip length

Parallel through connectors 20 - 630 mm² KS-P

- Material: Cu 99.95%, tin plated Cu/Sn.
- Cable inspection hole.
- For stranded (class 2) up to multi stranded (class 6) Cu-conductors, according to IEC 60228.



Marking example: 17 70 Elpress logotype included
17 = die no. 70 = mm²

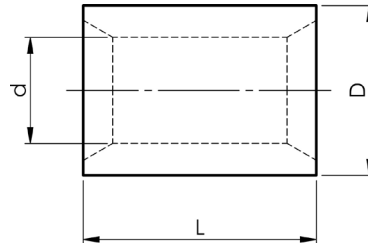

Conductor Cu mm ²	Name	d mm	D	L	Tool	Die	Pcs/pack
20-31	KS25P	8	11	14	PVL350, V600, V1300, V250	11L	200
31-41	KS35P	9	13	16	PVL350, V600, V1300, V250	13L	100
45-56	KS50P	11	14,5	18	PVL350, V600, V1300, V250	14,5L	100
60-85	KS70P	13	17	18	PVL350, V600, V1300, V250	17L	100
86-111	KS95P	15	20	20	V600, V1300, V250	20L	100
111-130	KS120P	17	22	26	V600, V1300, V250	22L	100
136-166	KS150P	19	25	26	V600, V1300, V250	25L	50
170-210	KS185P	21	27	28	V1300, V250	27L	50
220-255	KS240P	24	30	30	V1300, V250	30L	25
300	KS300P	26	32	35	V1300, V250	32L	50
400	KS400P	30	38	50	V1300, V250	38L	50
500	KS500P	33	42	52	V250, V1470	42L	10
630	KS630P	39	50	62	V250, V1470	50L	10

CUT through connectors for solid conductors 6 - 16 mm²

- Material: Cu 99,95%, tin plated, Cu/Sn.
- For solid conductors.

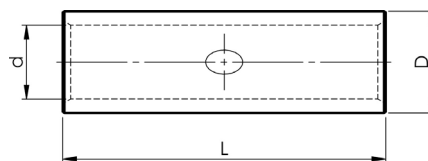

mm ²	Name	d mm	D	L	s	Tool	Pcs/pack
6	CUT6	3	5	27	12	ES2258, T2258	100
10	CUT10	4	6	27	12	ES2258, T2258	100
16	CUT16	5	8	35	15,5	ES2258, T2258	100

s = strip length

Al-Cu bimetallic through connectors 10 - 240 mm²

- Connect Al winding conductors to Cu stranded and flexible conductors.
- Al-range winding 20-310 mm². Cu-range 10-185 mm².

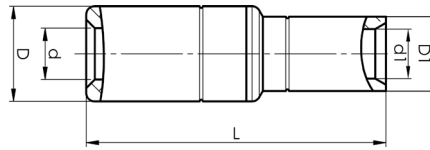

Stranded Al mm ²	Conductor Cu mm ²	Winding mm ²	Name	d mm	d1	D	D1	L	s	s1	Tool	Die (Cu)	Matrix and Punch (Al)	Pcs/pack
16-25	10-16	8,8-22	AKS1625-1016	6,2	6	11,5	9	36,5	19	17	V600	EW1025	TBKA9-11,5	48
30	10	20-40	AKS30L-10	7,5	4,9	13	7,9	48,5	29	16	V600, V1300	B8	13P13M2/D2	50
30	16	20-40	AKS30L-16	7,5	5,9	13	8,9	48,5	29	17	V600, V1300	B9L	13P13M2/D2	50
35	10	35-50	AKS35L-10	8,5	4,9	20	7,9	69	45	16	V1300	B8	13P20M2/D2	5
35	16	35-50	AKS35L-16	8,5	5,9	20	8,9	69	45	17	V1300	B9L	13P20M2/D2	5
35	25	35-50	AKS35L-25	8,5	7,9	20	10,9	74	45	20	V1300	B11L	13P20M2/D2	5
50	10	50-70	AKS50L-10	9,6	4,9	20	7,9	69	45	16	V1300	B8	13P20M2/D2	5
50	16	50-70	AKS50L-16	9,6	5,9	20	8,9	69	45	17	V1300	B9L	13P20M2/D2	5
50	25	50-70	AKS50L-25	9,6	7,9	20	10,9	74	45	20	V1300	B11L	13P20M2/D2	5
50	35	50-70	AKS50L-35	9,6	8,8	20	12,8	79	45	21	V1300	B13L	13P20M2/D2	5
50	50	50-70	AKS50L-50	9,6	10,8	20	14,3	83,5	45	25	V1300	B14,5L	13P20M2/D2	5
70	35	70-100	AKS70L-35	11,3	8,8	20	12,8	79	45	21	V1300	B13L	13P20M2/D2	5
70	50	70-100	AKS70L-50	11,3	10,8	20	14,3	83,5	45	25	V1300	B14,5L	13P20M2/D2	5
70	70	70-100	AKS70L-70	11,3	12,8	20	16,8	85,5	45	27	V1300	B17L	13P20M2/D2	5
95	35	100-125	AKS95L-35	12,5	8,8	25	12,8	94,5	60	21	V1300	B13L	13P25M2/D2	5
95	50	100-125	AKS95L-50	12,5	10,8	25	14,3	99	60	25	V1300	B14,5L	13P25M2/D2	5
95	70	100-125	AKS95L-70	12,5	12,8	25	16,8	101	60	27	V1300	B17L	13P25M2/D2	5
120	50	125-160	AKS120L-50	14	10,8	25	14,3	99	60	25	V1300	B14,5L	13P25M2/D2	5
120	70	125-160	AKS120L-70	14	12,8	25	16,8	101	60	27	V1300	B17L	13P25M2/D2	5
120	95	125-160	AKS120L-95	14	14,8	25	19,8	101,5	60	27	V1300	B20L	13P25M2/D2	5
150	70	160-216	AKS150L-70	15,8	12,8	25	16,8	101	60	27	V1300	B17L	13P25M2/D2	5
150	95	160-216	AKS150L-95	15,8	14,8	25	19,8	101,5	60	27	V1300	B20L	13P25M2/D2	5
150	120	160-200	AKS150L-120	15,8	16,8	25	21,8	106,5	60	32	V1300	B22L	13P25M2/D2	5
185	95	216-270	AKS185L-95	17,6	14,8	32	19,8	100,5	60	27	V1300	B20L	13P32M2/D2	5
185	120	216-270	AKS185L-120	17,6	16,8	32	21,8	105,5	60	32	V1300	B22L	13P32M2/D2	5
185	150	216-270	AKS185L-150	17,6	18,8	32	24,8	106	60	32	V1300	B25L	13P32M2/D2	5
240	120	270-310	AKS240L-120	19,8	16,8	32	21,8	105,5	60	32	V1300	B22L	13P32M2/D2	5
240	150	270-310	AKS240L-150	19,8	18,8	32	24,8	106	60	32	V1300	B25L	13P32M2/D2	5
240	185	270-310	AKS240L-185	19,8	20,8	32	26,8	106,5	60	32	V1300	B27L	13P32M2/D2	5

s, s1 = insulation stripping length



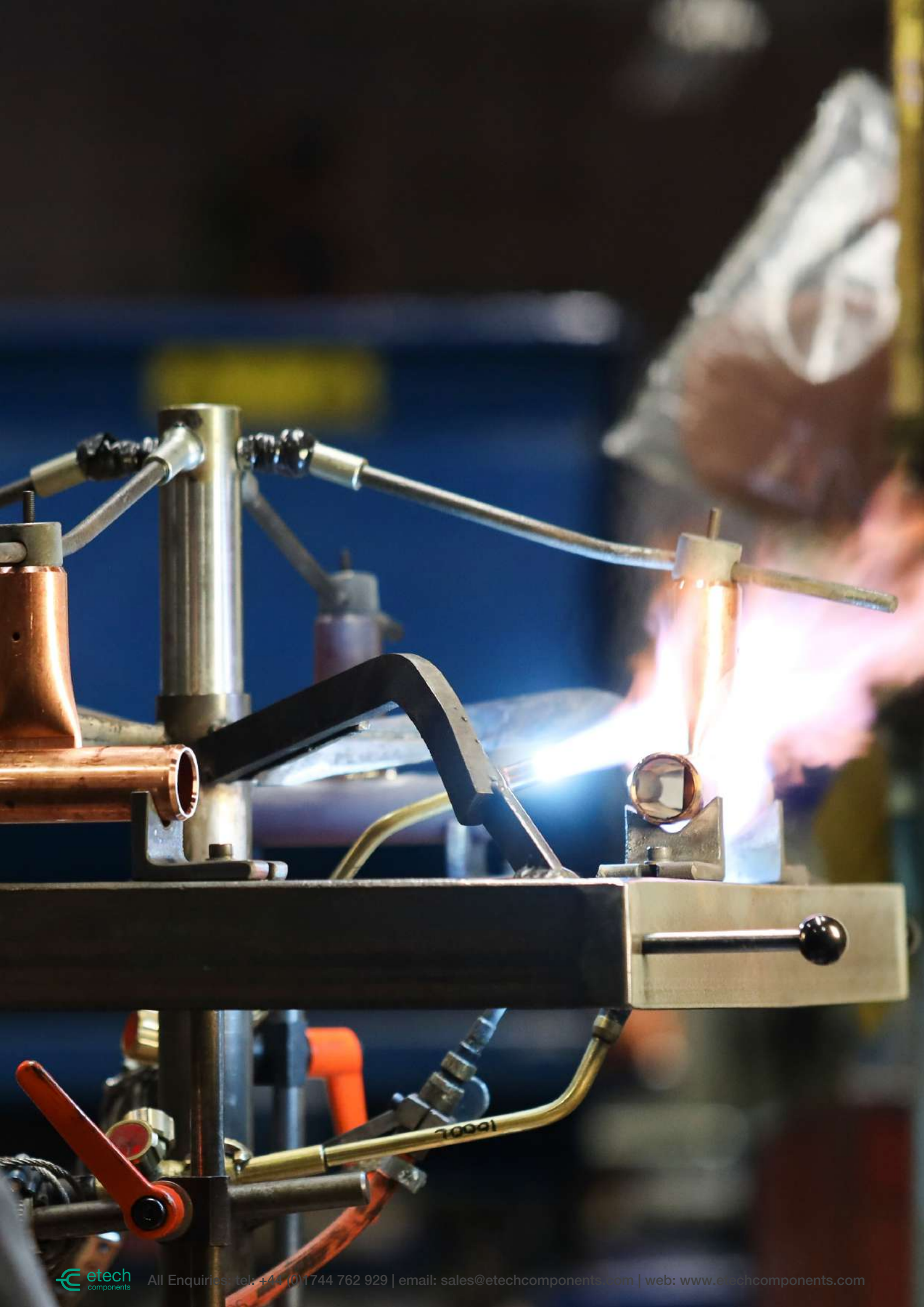

Earthing and braids

Flat, flexible braids

Earthing braids with flat, twined, highly flexible Cu-conductor, uncoated 0,09 - 400 mm².



- Broad range of flexible and highly flexible flat earth braids.
- Customer unique solutions are available.
- Braids in other materials, such as stainless steel, aluminium or insulated connectors could also be provided.

Uncoated earthing braid: **FJCU area (mm²) - length (mm) - Hole size**

Example: **FJCU50-100-8**

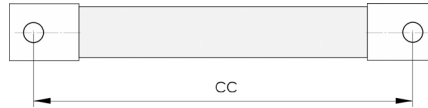

Flat, flexible braids (tin plated)

Earthing braids with flat, twined, highly flexible Cu-conductor, tin plated 0,09 - 400 mm².



- Broad range of flexible and highly flexible flat earth braids.
- Customer unique solutions can be made.
- Braids in other material, such as stainless steel, aluminium or insulated connectors are also available.

Tin plated earthing braid: **FJCUSN area (mm²) - length (mm) - Hole size**

Example: **FJCUSN50-100-8**

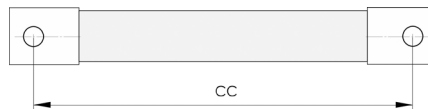

Round, flexible connections (un-insulated)

Un-insulated slacks with many possibilities to connect Epress terminals.

Such as KSF/KRF Cu tube terminal range, AlCu bi-metallic range

AKK/AKS or Al range AK/AS.

Round, twined, highly flexible Cu-conductor, tin plated or uncoated, 0,06 - 600 mm².



- Broad range of flexible and highly flexible flat earth braids.
- Customer unique solutions available.
- Braids in other materials, such as stainless steel, aluminium or insulated connectors are also available.

Uncoated earthing braid (round): **FLCU area (mm²) - length (mm) - Hole size**

Example: **FLCU50-100-8**

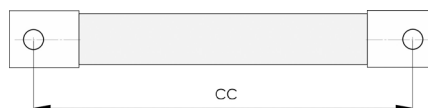

Round, flexible connections (un-insulated, tin plated)

Un-insulated slacks with many possibilities to connect Elpress terminals. Such as KSF/KRF Cu tube terminal range, AlCu bi-metallic range AKK/AKS or Al range AK/AS.

Round, twined, highly flexible Cu-conductor, tin plated or uncoated, 0,06 - 600 mm².



- Broad range of flexible and highly flexible flat earth braids.
- Customer unique solutions could be made.
- Braids in other materials, such as stainless steel, aluminium or insulated connectors could also be provided.

Tin plated earthing braid (round): FLCUSN area (mm²) - length (mm) - Hole size

Example: FLCUSN50-100-8

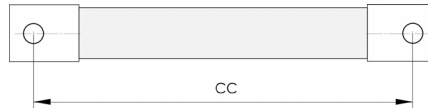

Round, flexible connections (insulated)

Insulated slacks with many possibilities to connect Elpress terminals. Such as KSF/KRF Cu tube terminal range, AlCu bi-metallic range AKK/AKS or Al range AK/AS.

Round, twined, highly flexible Cu-conductor, tin plated or uncoated, 0,06 - 600 mm².



- Customer unique slack, possible to make according to customer requirements.
- Insulated braids in other materials, such as stainless steel, aluminium or insulated connectors could also be provided.

Insulated, uncoated slacks: FKCU area (mm²) - length (mm) - Hole size

Example: FKCU50-100-8

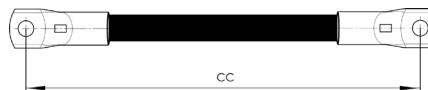

Slacks













Type	Conductor mm ²	Hole	Description	Used with (combine terminals freely)
KRF	CU 16-800	M range	Terminal	CU conductors
KSF	CU 16-800		Connector	CU conductors
AKS	AL/CU 10-400/10-300	M range	Connector	CU and/or AL conductors
AKK	AL 16-1200		Terminal	AL conductors
AKP	AL 16-1200	M range	Pin terminal	AL conductors
KR	CU 0,75-10		Terminal	CU conductors
KS	CU 0,75-10		Connector	CU conductors

Common information

Hydraulic crimp systems

Elpress hydraulic crimp systems crimp from 10 to 1200 mm². The systems consist of pumps and crimp heads that can be freely combined or with complete hand-held tools, where these devices are integrated. Wide range of accessories available for crimping, pre-rounding, cutting etc. Together with the matching terminals, the complete system is formed. Both pumps and hand-held tools have, with a few exceptions, quick feed function that means crimping can begin after a few pump strokes.

The systems have a built-in ratchet lock that ensures that an initial crimp is completed and thus produces results with the characteristics. Pumps that can be connected to the different crimp heads provide the option of comfortable work in difficult situations and with maximum flexibility.

System	Material	mm ²																														
		0,25	0,5	0,75	1,5	2,5	4	6	10	16	25	35	50	70	95	120	150	185	240	300	400	500	630	800	1000	1200						
 DKB0325	Cu	■																														
 DKB0760	Cu		■																													
 GWB4099/ GWB4099C	Cu					■																										
 ES2258	Cu						Cut 6-16 mm ²																									
 T2258	Cu						Cut 6-16 mm ²																									
 PVL350	Cu					■																										
 600	Cu							winding 30-185 mm ²																								
 1300	Cu							winding 30-343 mm ²																								
 1300	Al							winding 20-310																								
 250	Cu							winding 180-730 mm ²																								
 ES2258LB5	tap changers (Cu)																															
 ES2258LB7	tap changers (Cu)																															
 PVL130L	tap changers (Cu)																															

Manual crimping tools for off-load transformer tap changers



ES2258LB5



A tested and certified crimping tool for solid copper wires of diameters 2.5-2.8 mm in combination with 5 mm transformer tap changer connectors.

Crimp geometry



Name	Crimp geometry	Net weight (kg)	Length mm	Width
ES2258LB5	Hexagonal	0,645	300	30



ES2258LB7



A tested and certified crimping tool for solid copper wires of diameter 4.0 mm in combination with 7 mm transformer tap changer connectors.

Crimp geometry



Name	Crimp geometry	Net weight (kg)	Length mm	Width
ES2258LB7	Hexagonal	0,645	300	30

Manual crimping tools for Cu connectors



DKB0325



Tested and certified mechanical hand tool for indent crimping Cu terminals 0.25-2.5 mm².

mm ²	Name	Crimp geometry	Net weight (kg)	Length mm	Width
0,25-2,5	DKB0325	Tab	0,444	192	66

Crimp geometry



DKB0760



Tested and certified mechanical hand tool for indent crimping Cu terminals 0.75-6 mm².

mm ²	Name	Crimp geometry	Net weight (kg)	Length mm	Width
0,75-6	DKB0760	Tab	0,445	192	66

Crimp geometry



GWB4099 and GWB4099C



Tested and certified mechanical Miniforce hand tool for W crimping un-insulated ring, fork and pin terminals as well as tube terminals and through connectors type KR and KS 4-10 mm².

mm ²	Name	Crimp geometry	Net weight (kg)	Length mm	Width
4-10	GWB4099	W	0,542	203	76
4-10	GWB4099C	W	0,560	256	80

Crimp geometry





ES2258



Tested and certified mechanical hand-held tool for crimping Cu-terminals, type CUT 6-16 mm² and KR/KS 4-10 mm².

mm ²	Name	Crimp geometry	Net weight (kg)	Length mm	Width
4-16	ES2258	Hexagonal	0,660	300	30

Crimp geometry



T2258



Tested and certified mechanical hand-held tool for crimping Cu-terminals, type CUT 6-16 mm² and KR/KRF/KS/KSF 4-16 mm².

mm ²	Name	Crimp geometry	Net weight (kg)	Length mm	Width
4-16	T2258	Punch, Hexagonal	0,650	304	30

Crimp geometry



Battery powered crimp tool for crimping off-load transformer tap changers



PVL130L



Tested and certified tool with a high performance Li-Ion battery that streamlines your work with its improved battery capacity. To be used for crimping of standard tap changers for 30A and 63 A.

Properties:

- easy-to-open crimp head for rapid die change
- slim ergonomic design - good accessibility even in confined areas
- Li-Ion battery (12 V MAX, 2,0 Ah), charge time approx. 40 minutes
- rapid crimp operation 2 seconds (depending on material)
- dies for crimping of special through connectors
- delivered in a plastic case ,with extra space for accessories

Name	Crimp geometry	Net weight (kg)	Length	Width	Height	Delivered
PVL130L	Hexagonal	1,50	330	85	60	with battery and charger
PVL130LDBKIT	Hexagonal	1,69	330	85	60	Includes PVL130L, LB5, LB7 and two batteries with charger
PVL130L-US	Hexagonal	1,50	330	85	60	with battery and US-charger
PVL130L-WOBC	Hexagonal	0,91	330	85	60	without battery and charger

Crimp geometry



Dies for PVL130L

Dies for crimping solid copper wires in combination with transformer tap changer connectors.

- Designed for standardized 30 A and 63 A tap changers.
- Hexagonal crimp geometry.



∅	Name	Number of crimps	Die holder required	Note
5	LB5	1	No	For standardized 30 A and 63 A tap changers
7	LB7	1	No	For standardized 30 A and 63 A tap changers

Battery powered tool PVL350 for crimping Cu-terminals



PVL350 - Elpress Mini

Battery-powered tool for crimping tube terminals and through connectors of type KRF/KSF up to 70 mm² with special "MB" dies.

Properties:

- opening head for easy die changes and good accessibility
- High-performance 12 V Li-Ion battery with indication of charge status
- very good accessibility and ergonomics
- opening, rotatable "flip top" head for easy die changes and slim crimp head for good accessibility
- rapid crimp sequence 3-4 seconds
- approx. 100-180 crimps/battery charges (depending on temp, frequency etc.)
- 2-component housing with grip-friendly protection. One-handed operation for easy control of all tool functions
- Lightweight, and rapid crimping sequence for maximum efficiency
- Automatic return of the dies when crimping is complete



Crimp geometry



mm ²	Name	Crimp geometry	Net weight (kg)	Length mm	Width	Height	Delivered
4-95	PVL350	Hexagonal	1,60	360	116	75	with charger 230VAC
4-95	PVL350-US	Hexagonal	1,60	360	116	75	with charger 115VAC
4-95	PVL350-WOBC	Hexagonal	1,10	360	116	75	without battery and charger

Crimp dies to PVL350 (KR/KRF, KS/KSF, CUT, C-sleeves)

Supplied in pairs.

For hexagonal crimping of Cu 4-70 mm². CUT sleeves 6-16 mm² crimped with MB4016.



Die pair MB11 for PVL350.

mm ²	Name	Number of crimps	Net weight (kg)	Used for
10 - 16	MB8	1	0,086	KR/KS 10 mm ² and KR/D/KSD 10-16 mm ²
16 - 25	MB9	1	0,085	KRF/KSF 16 mm ² and KR/D/KSD 25 mm ²
25 - 35	MB11	2	0,083	KRF/KSF 25 mm ² and KR/D/KSD 35 mm ²
35	MB13	2	0,081	KRF/KSF 35 mm ²
50	MB14,5	2	0,080	KRF/KSF 50 mm ²
70 - 95	MB17	3	0,075	KRF/KSF 70 mm ² and KR/D/KSD 95 mm ²
4-10	MB4016	1	0,082	KR/KS 4-10 mm ² , CUT sleeves 6-16 mm ²

System 600 for crimping Cu and Al terminals



CE

V600



Tested and certified crimp head for crimping Cu terminals, type KR/KS 10 mm², KRF/KSF 16-150 mm², Cu windings 25-185 mm², Al-terminals 16-25 mm² (-35 solid). Can be used together with the foot pump P4000 or the electrically powered pump PS710E/R (battery powered version of PS710E is also available).

Properties:

- working pressure 63 MPa (630 bar)
- crimp force 55 kN
- robust fabric bag with room for 10 dies included

mm ²	Name	Crimp geometry	Net weight (kg)	Length mm	Width	Height
10-150	V600	Punch, Hexagonal	2,45	189	74	53

Crimp geometry

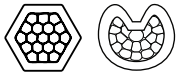

CE

V611



Tested and certified hydraulic hand-held tool for crimping Cu-terminals, type KR/KS 10 mm², KRF/KSF 16-150 mm², Cu windings 25-185 mm², Al-terminals 16-25 mm² (-35 solid).

• Properties:

- fast-feed to crimp engagement provides short crimp times
- crimp force 60 kN
- delivered in sturdy textile bag

mm ²	Name	Crimp geometry	Net weight (kg)	Length mm	Width	Height
10-150	V611	Punch, Hexagonal	2,60	425	115	53

Crimp geometry

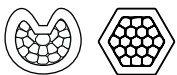

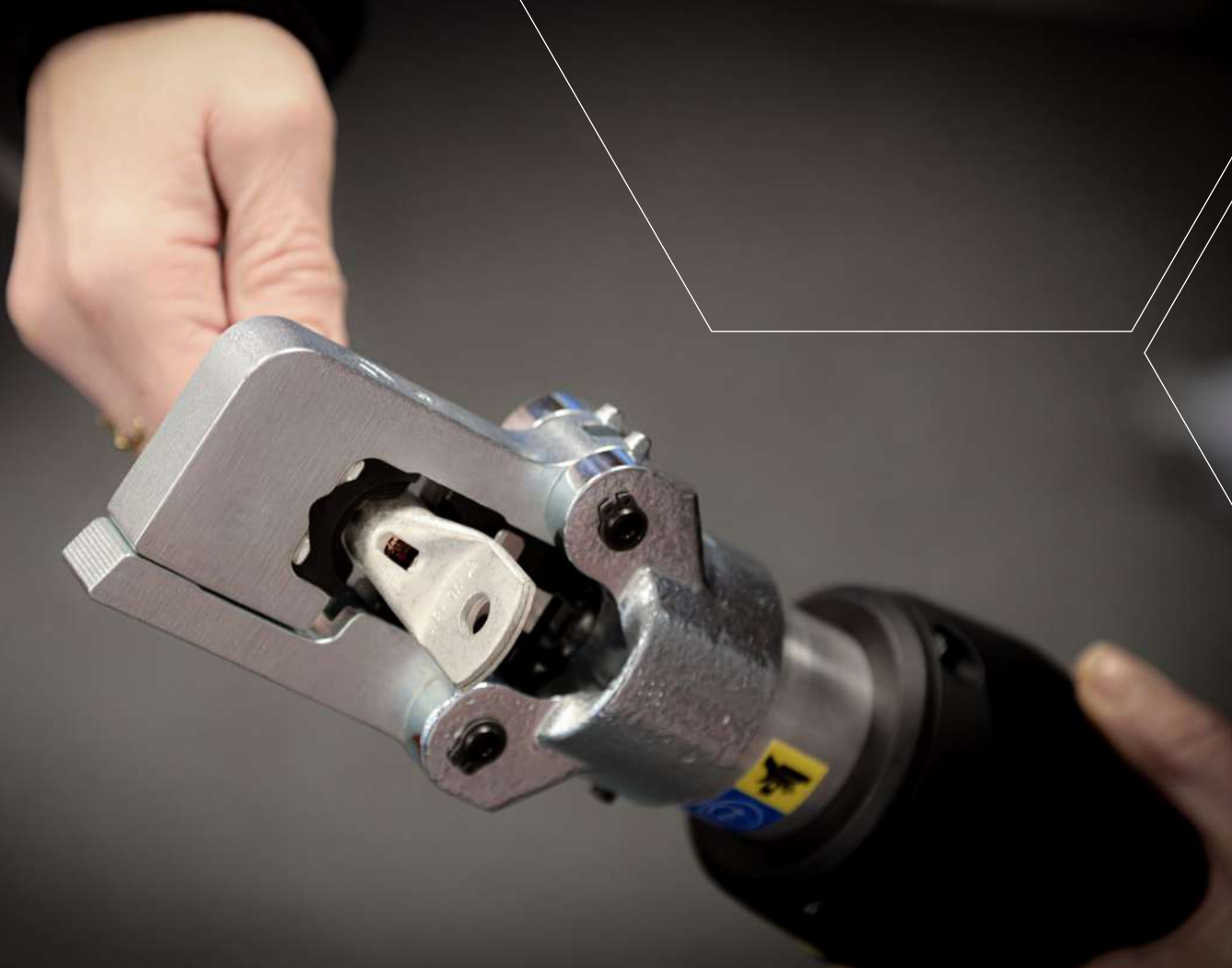

PVX611/PVX611DB

Tested and certified battery-powered crimp tool for crimping Cu-terminals, type KR/KS 10 mm², KRF/KSF 16-150 mm², Cu windings 25-185 mm², Al-terminals 16-25 mm² (-35 solid). PVX611DB has an extra battery.

Properties:

- protects against dirt and dust through the closed chassis
- ergonomic design ensures optimum balance in the user's hand
- swivel opening crimp fork
- crimp force control using pressure monitoring
- one handed operation for easy work
- LED lighting for easier work
- fast-forward feeding for more efficient crimping
- display with information about the tool and service intervals
- crimp monitoring via display when the correct pressure/complete crimping is not achieved (warning light LED and signal)
- Li-Ion battery included (18 V, 2,0 Ah)



Crimp geometry



mm ²	Name	Crimp geometry	Net weight (kg)	Length mm	Width	Height	Delivered
10-240	PVX611	Punch, Hexagonal	5,50	414	116	75	with charger 230VAC
10-240	PVX611DB	Punch, Hexagonal	5,85	414	116	75	with 2 batteries
10-240	PVX611-US	Punch, Hexagonal	5,50	414	116	75	with charger 115VAC
10-240	PVX611-WOBC	Punch, Hexagonal	3,90	414	116	75	without battery and charger

Accessories for system 600

- For crimping Cu terminals 10-150 mm² or Cu windings 25-185 mm².
- The KB/TB dies below are intended for Cu-terminals, type KR/KRF and KS/KSF, together with both stranded and multi-stranded Cu conductors of Class 2 and 5 respectively according to IEC 60228.
- TB/KB (L) are intended for Cu-windings.
- Be sure to use dies exactly matching the terminal.

Crimp dies for KRF/KSF

For Cu-terminals, hexagonal crimping. Supplied in pairs.
The TB dies below are intended for Cu-terminals, type KRF/KSF, together with Cu conductor according to IEC 60228.



Die pair TB9-13 for V600, V611 and PVX611.



Die pair KB22 for V600, V611 and PVX611.

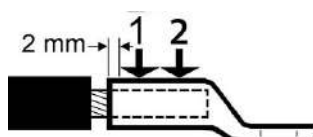

Crimp sequence for two crimps.

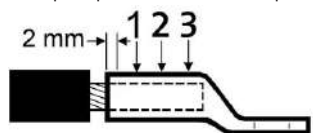

Crimp sequence for three crimps.

mm ²	Name	Number of crimps	Net weight (kg)	Die holder required	Note
10 / 70	TB8-17	1, 2	0,138	No	Used for KRF/KSF 10 mm ² and 70 mm ² respectively
16 / 35	TB9-13	1	0,149	No	Used for KRF/KSF 16 mm ² and 35 mm ² respectively
25 / 50	TB11-14,5	1	0,149	No	Used for KRF/KSF 25 mm ² and 50 mm ² respectively
10 / 95	TB7-20	1, 2	0,135	No	Used for KRF/KSF 10 mm ² and 95 mm ² respectively
120	KB22	3	0,150	No	
150	KB25	3	0,147	No	

Crimp dies for KRF/KSF (L)

For Cu-terminals, hexagonal crimping. Supplied in pairs.
The TB dies below are intended for Cu-terminals, type KRF/KSF (L), together with Cu winding conductors, stranded and multi-stranded Cu conductors of Class 2 and 5 respectively according to IEC 60228.



mm ²	Winding mm ²	Name	Number of crimps	Net weight (kg)	Die holder required
25	30-47	TB11L	1	0,149	No
35	45-70	TB13L	1	0,147	No
50	69-103	TB14,5L	1	0,144	No
70	100-120	TB17L	2	0,134	No
95	113-161	TB20L	2	0,131	No
120	145-185	KB22L	3	0,139	No

Crimp dies for Al and Cu, V600 system

For crimping 16-25 mm² Al and 10-16 mm² Cu.
Used in the V600 system.



Punch crimping.

The dies below are intended to be used together with Cu/Al conductors according to IEC 60228.

mm ²	Name	Number of crimps	Net weight (kg)	Note
Cu 10 - 16, / AL 16 - 25	TBKA9-11,5	1	0,140	Used to crimp AS1625 and AKS1625-1016





V1300



V1300 crimp head

V1300A

Crimp geometry

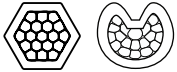

Tested and certified crimp head for crimping Cu-terminals, type KR/KRF and KS/KSF 10-400 mm², Cu-windings 25-343 mm², Al-terminals 16-400 mm² (-240 solid), Al-windings 20-310 mm². Used in conjunction with foot pump P4000 or the electrically powered pump PS710 (battery powered version of PS710E is also available).

Properties:

- crimps Cu-conductors of type KRF-L up to 240 mm²
- working pressure 63 MPa (630 bar)
- crimp force 130 kN (13 tons)
- versatile and easy-to-use steel crimp head

mm ²	Name	Crimp geometry	Net weight (kg)	Length mm	Width	Height	Note
10-400	V1300	Hexagonal, Punch	3,46	270	82	75	
10-400	V1300A	Hexagonal, Punch	3,40	270	82	75	Closed fork design, for longer durability



V1300L



Crimp geometry

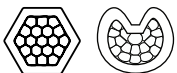

Tested and certified crimp head for crimping Cu-terminals, type KR/KRF and KS/KSF 10-400 mm², Cu-windings 25-343 mm², Al-terminals 16-400 mm² (-240 solid) Al-windings 20-310 mm². Used in conjunction with foot pump P4000 or the electrically powered pump PS710 (battery powered version of PS710E is also available).

Properties:

- crimps Cu-conductors of type KRF-L up to 240 mm²
- equipped with protective rubber coating on top of the fork and oil spray safety protection cap
- working pressure 63 MPa (630 bar)
- crimp force 130 kN (13 tons)
- versatile and easy-to-use steel crimp head

mm ²	Name	Crimp geometry	Net weight (kg)	Length mm	Width	Height
10-400	V1300L	Hexagonal, Punch	3,40	270	82	75

PVX1300/PVX1300DB

Tested and certified battery-powered crimp gun for contact crimping Cu-terminals, type KR/KRF and KS/KSF 10-400 mm², Cu-windings 25-343 mm², Al-terminals 16-400 mm² (-240 solid) Al-windings 20-310 mm².



Properties:

- crimps Cu-conductors of type KRF-L up to 240 mm²
- ergonomic design ensures optimum balance in the user's hand
- crimp monitoring with warning light and signal when the correct pressure/full crimp is not achieved
- LED work lighting
- crimp force 124 kN (13 tons)
- crimps/charging: 60-120 depending on size and temperature
- crimp time: 4-12s depending on size
- usage temperature -20°C to +40°C
- Li-Ion Makita, 5.0 Ah, 18V
- charger Li-Ion Makita, charging time 22 min



CASE ADVANCED

Crimp geometry

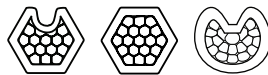

mm ²	Name	Crimp geometry	Net weight (kg)	Length	Width	Height	Delivered
10-400	PVX1300-ADV	Punch, Dual, Hexagonal	14,2	412	319	75	in CASE ADV
10-400	PVX1300DB-ADV	Punch, Dual, Hexagonal	14,8	412	319	75	with 2 batteries and CASE ADV
10-400	PVX1300-WOBC-ADV	Punch, Dual, Hexagonal	12,4	412	319	75	in CASE ADV and without battery and charger
10-300	PVX1300-ADV-US	Punch, Dual, Hexagonal	14,2	412	319	75	with battery and US-charger



V1300C2

Crimp head for crimping Cu-terminals, type KR/KRF and KS/KSF 10-400 mm² and Cu-windings 25-343 mm². Used in conjunction with foot pump P4000 or battery and mains powered pump PS710 (battery powered version of PS710E is also available).

Properties:

- working pressure 63 MPa (630 bar)
- crimp force 130 kN
- versatile and easy to use



Crimp head V1300C2 with dies.

Crimp geometry

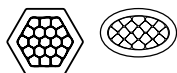

mm ²	Name	Crimp geometry	Net weight (kg)	Length mm	Width	Height
10-400	V1300C2	Hexagonal, Oval	4,60	297	145	75



PVX1300C2/PVX1300C2DB

Tested and certified battery-powered crimp gun for crimping Cu-terminals, type KR/KRF and KS/KSF 10-400 mm², Cu-windings 25-343 mm².

Properties:

- ergonomic design ensures optimum balance in the user's hand
- crimp monitoring with warning light and signal when the correct pressure/full crimp is not achieved
- LED work lighting
- crimp force 124 kN (13 tonnes)
- usage temperature -20°C to +40°C
- Li-Ion Makita, 5.0 Ah, 18V
- charger Li-Ion Makita, charging time 22 min

Crimp geometry



mm ²	Name	Crimp geometry	Net weight (kg)	Length mm	Width	Height	Delivered
10-400	PVX1300C2-ADV	Dual, Hexagonal	15,1	399	319	75	in CASE ADV
10-400	PVX1300C2DB-ADV	Dual, Hexagonal	15,1	399	319	75	2 batteries and CASE ADV
10-400	PVX1300C2-WOBC-ADV	Dual, Hexagonal	5,6	399	319	75	without battery and charger



Accessories for system 1300

- The B (L) dies below are intended for Cu-terminals, type KR/KRF and KS/KSF, together with Cu winding conductors.
- Be sure to use dies exactly matching the terminal.

Pre-rounding of Cu

For pre-rounding copper winding conductors to fit the connector in question.



mm ²	Winding mm ²	Matrix	Punch	Number of crimps	Matrix holder required	Punch holder required
25	30-47	13R8ML-B	13R8DL-B	1	No	No
35	45-70	13R9ML-B	13R9DL-B	1	No	No
50	69-103	13R11ML-B	13R11DL-B	1	No	No
70	100-120	13R13ML-B	13R13DL-B	1	No	No
95	113-161	13R15ML-B	13R15DL-B	1	No	No
120	145-185	13R17ML-B	13R17DL-B	1	No	No
150	180-220	13R19ML-B	13R19DL-B	1	No	No

Crimp dies for Cu

Supplied as a pair. For hexagonal crimping of Cu terminals and connectors. May be used on flexible (class 5) as well as stranded (class 2) conductors and for winding conductors in Transformer manufacture.



mm ²	Winding mm ²	Name	Number of crimps	Die holder required
10	9,9-14	13PK8DL/ML	1	No
16	14-22	13B9L	1	No
25	30-47	13B11L	1	No
35	45-70	13B13L	1	No
50	69-103	13B14,5L	1	No
70	100-120	13B17L	1	No
95	113-161	13B20L	1	No
120	145-185	13B22L	2	No
150	180-220	13B25L	2	No
185	220-265	13B27L	2	No
240	302-343	13B30L	2	No

Crimp dies for crimping of KS-PL

For crimping of parallel copper through connectors for transitions between winding- and flexible conductors.



mm ²	Winding mm ²	Matrix	Punch	Number of crimps	Matrix holder required	Punch holder required
50	69-103	13P14,5ML	13P14,5DL	1	No	No
70	100-120	13P17ML	13P17DL	1	No	No
95	113-161	13P20ML	13P20DL	1	No	No
120	145-185	13P22ML	13P22DL	1	No	No
150	180-220	13P25ML	13P25DL	1	No	No
185	220-265	13P27ML	13P27DL	1	No	No
240	302-343	13P30ML	13P30DL	1	No	No

Crimp dies (C fork) for Cu winding

Supplied in pairs.

For Cu-terminals with winding conductors, hexagonal crimping. Used without a die holder.

May be used on flexible (class 5) as well as stranded (class 2) conductors and for winding conductors in Transformer manufacture.

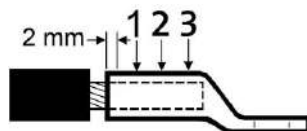

Crimp sequence for three crimps.

mm ²	Name	Number of crimps	Net weight (kg)	Die holder required
50	13CB14,5L	1	0,500	No
70	13CB17L	1	0,480	No
95	13CB20L	1	0,497	No
120	13CB22L	2	0,537	No
150	13CB25L	2	0,500	No
185	13CB27L	2	0,478	No
240	13CB30L	2	0,500	No

Pre-rounding of Al

For pre-rounding aluminium winding conductors to fit the connector in question.



The nominal size of the connection	Winding mm ²	Matrix	Punch	Number of crimps	Matrix holder required	Punch holder required
30	20-40	13R7.5ML-AL	13R7.5DL-AL	1	No	No
35	35-50	13R8ML-AL	13R8DL-AL	1	No	No
50	50-70	13R9ML-AL	13R9DL-AL	1	No	No
70	70-100	13R10ML-AL	13R10DL-AL	1	No	No
95	100-125	13R12ML-AL	13R12DL-AL	1	No	No
120	125-160	13R13ML-AL	13R13DL-AL	1	No	No
150	160-216	13R15ML-AL	13R15DL-AL	1	No	No
185	216-270	13R17ML-AL	13R17DL-AL	1	No	No
240	270-310	13R19ML-AL	13R19DL-AL	1	No	No

Punch and matrix for Al

For crimping of the aluminium side of the bimetallic connector.



Stranded Al mm ²	Winding mm ²	Matrix	Punch	Number of crimps	Matrix holder required	Punch holder required
16	8,8-22	13P13M2	13P13D2	1	No	No
30	20-40	13P13M2	13P13D2	1	No	No
35-70	35-50, 50-70, 70-100	13P20M2	13P20D2	1	No	No
95-150	100-125, 125-160, 160-216	13P25M2	13P25D2	1	No	No
185-240	216-270, 270-310	13P32M2	13P32D2	1	No	No



Storage box for system 1300

Case with space for tool V1300L and all necessary accessories to crimp Elpress Cu-and Al-terminals. The case has a solid moulded interior and can be used as a storage place in storage rooms or taken into the workplace.

Properties:

- IP67 rated, withstands dust and heavy impacts
- sturdy, form cut inserts



Name	Net weight (kg)	Depth mm	Width	Height	Notes
LV1300L-ADV	4,86	428	555	211	Empty storage box with slots for crimp head V1300L and accessories

System 250 for crimping Cu and Al terminals



V250



Tested and certified crimp head for crimping Cu-terminals, type KRF/KSF 10-630 mm², Cu-windings 220-730 mm². Used in conjunction with foot pump P4000 or the electrically powered pump PS710 (battery powered version of PS710E is also available).

Properties:

- working pressure 63 MPa (630 bar)
- crimp force 250kN (25 tons)
- large crimp area, 10-630 mm²

mm ²	Name	Crimp geometry	Net weight (kg)	Length mm	Width	Height
10-630	V250	Punch, Hexagonal	4,68	280	111	74

Crimp geometry

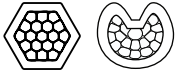

V250L



Tested and certified crimp head for crimping Cu-terminals, type KRF/KSF 10-630 mm², Cu-windings 220-730 mm². Used in conjunction with foot pump P4000 or the electrically powered pump PS710 (battery powered version of PS710E is also available).

Properties:

- equipped with protective rubber coating on top of the fork and oil spray safety protection cap
- working pressure 63 MPa (630 bar)
- crimp force 250kN (25 tons)
- large crimp area, 10-630 mm²

mm ²	Name	Crimp geometry	Net weight (kg)	Length mm	Width	Height
10-630	V250	Punch, Hexagonal	4,68	280	111	74

Crimp geometry

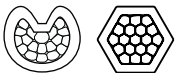

Accessories for system 250

- The B (L) dies below are intended for Cu-terminals, type KR/KRF and KS/KSF, together with Cu winding conductors.
- Be sure to use dies exactly matching the terminal.

Pre-rounding of Cu

For pre-rounding copper winding conductors to fit the connector in question.



mm ²	Winding mm ²	Matrix	Punch	Number of crimps	Matrix holder required	Punch holder required
185	220-265	25R21ML	25R21DL	1	No	No
240	302-343	25R24ML	25R24DL	1	No	No
300	340-400	25R26ML	25R26DL	1	No	No
400	412-500	25R30ML	25R30DL	1	No	No
500	500-580	25R33ML	25R33DL	1	No	No
630	630-730	25R39ML	25R39DL	1	No	No

Crimp dies for Cu

Supplied in pairs.

For hexagonal crimping of Cu terminals and connectors.

May be used on flexible (class 5) as well as stranded (class 2) conductors and for winding conductors in Transformer manufacture.



mm ²	Winding mm ²	Name	Number of crimps	Die holder required
150	180-220	B2525L	1	No
185	220-265	B2527L	1	No
240	302-343	B2530L	1	No
300	340-400	B2532L	1	No
400	412-500	B2538L	2	No
500	500-580	B2542L	2	No
630	630-730	B2550L	3	No

Crimp dies for crimping of KS-PL

For crimping of parallel copper through connectors for transitions between winding- and flexible conductors.



mm ²	Winding mm ²	Working area mm ²	Matrix	Punch	Number of crimps	Matrix holder required	Punch holder required
300	136-170	286-320	P2532ML	P2532DL	1	No	No
400	170-255	355-440	P2538ML	P2538DL	1	No	No



Storage box for system 250

Case with space for tool V250L and all necessary accessories to crimp Elpress Cu-and Al-terminals. The case has a solid moulded interior and can be used as a storage place in storage rooms or taken into the workplace.

Properties:

- IP67 rated, withstands dust and heavy impacts
- sturdy, form cut inserts



Name	Net weight (kg)	Depth mm	Width	Height
LV250L-ADV	4,8366	428	555	211

System 350 for crimping Cu terminals



DV350

DV350 is a powerful and efficient crimp head with 35 tons crimp force. The head is used together with the electrically driven pump PS710 (the battery powered version, PS710E, is also available) or foot pump P4000, which makes the DV350 excellent for both mobile and stationary work. The tool is also available as DV350L with rubberised forks.

Properties:

- Working pressure 63 MPa (630 bar)
- Crimp force 350 kN (35 tons)
- Large crimp area, 240-800 mm²
- Crimp dies for crimping copper 240-800 mm² (winding conductor 340-960 mm²)
- Delivered fixed on a solid foot with a handle

Name	Art.nr.	Weight kg	Height mm	Width	Length
DV350	5208-350000	16,6	210	150	356
DV350L	5208-350100				

Accessories for system 350

Pre-rounding of Cu

Connector size, mm ²	Winding, mm ²	Matrix	Punch
300	340-400	35R26ML	35R26DL
400	412-500	35R30ML	35R30DL
500	500-580	35R33ML	35R33DL
630	630-730	35R39ML	35R39DL
800	720-960	35R42ML	35R42DL



Crimp dies for Cu

Flexible, stranded, mm ²	Winding, mm ²	Dies	No. Of crimps
240	302-343	B3530L	1
300	340-400	B3532L	1
400	412-500	B3538L	1
500	500-580	B3542L	1
630	630-730	B3550L	2
800	720-960	B3553L	2



PS710

Compact. Strong. Reliable.

PS710



PS710

The PS710 is an electrically driven pump for crimping with advanced control and monitoring of crimping progress. A flexible system for a wide range of applications with high performance and reliability for professional use. The pump is suitable for cabling manufacturers as well as for fitters working in the field. The PS710 can be used for all types of crimping or cutting.



PS710E

For users working in the distribution network or industry.

Properties:

- small and light weight, which makes the product easy to use in every situation
- maximum performance, can be used both with Li-ion battery 28.8 V or 220V mains power
- LCD Display with keypad for full status information of pump to the fitter
- to be used with crimp heads and cable cutters
- charger 230 VAC 50 Hz, 10.8-28.8 V, charging time 65 min

Name	Net weight (kg)	Length mm	Width	Height
PS710E	12,0	370	170	280

PS710E251 and PS710E501*



Properties:

- pump E-version
- cable
- hydraulic hose 2.4 m **or** 5.0 m with wireless communication ERGOCOM
- battery
- charger
- carrying strap
- 110-240VAC 50-60Hz

Name	Gross weight (kg)	Length mm	Width	Height	Note
PS710E251	24,5	370	170	280	PS710E pump with carrying strap. Ergocom hose 2.4 m and power cord EU, battery and charger
PS710E501	26,0	370	170	280	PS710E pump with carrying strap. Ergocom hose 5.0 m and power cord EU, battery and charger

* ERGOCOM hoses are not available in US/North American market.



PS710E251-ERGO and PS710E501-ERGO

Contains:

- pump E-version
 - mains cable for EU
 - hydraulic hose 2.4 m **or** 5.0 m
 - battery and charger
 - carrying strap
 - Elpress ergonomic handle ERGO (No Bluetooth)
-

PS710E251-RAK and PS710E501-RAK

Contains:

- pump E-version
- mains cable for EU
- hydraulic hose 2.4 m **or** 5.0 m
- battery and charger
- carrying strap
- Elpress handle straight



PS710E251-ERGO-WOBC and PS710E501-ERGO-WOBC

Contains:

- pump E-version
 - mains cable for EU
 - hydraulic hose 2.4 m **or** 5.0 m
 - without battery and charger
 - carrying strap
 - Elpress ergonomic handle ERGO (No Bluetooth)
-



PS710E251-RAK-WOBC and PS710E501-RAK-WOBC

Contains:

- pump E-version
- mains cable for EU
- hydraulic hose 2.4 m **or** 5.0 m
- without battery and charger
- carrying strap
- Elpress handle straight





PS710R

For users looking for a reliable standard product.

Properties:

- relay controlled pump
- mains operated 85-276 VAC 50-60Hz
- to be used with crimp heads and cable cutters
- Elpress ergonomic handle ERGO, with wired communication, can be selected for

Name	Net weight (kg)	Length mm	Width	Height
PS710R	12,0	370	170	280

PS710R250 and PS710R500

Electro-hydraulic pump for users looking for a reliable standard product

Properties:

- relay controlled pump
- mains operated 85-276 VAC 50-60Hz
- hydraulic hose 2.4 m **or** 5.0 m Elpress ergonomic handle ERGO
- cable
- carrying strap



Name	Gross weight (kg)	Length mm	Width	Height	Note
PS710R250	23,0	370	170	280	PS710R pump with carrying strap. Ergo hose 2.4 m and power cord EU
PS710R500	24,5	370	170	280	PS710R pump with carrying strap. Ergo hose 5.0 m and power cord EU



PS710R250-RAK and PS710R500-RAK

Contains:

- pump R-version
- mains cable for EU
- hydraulic hose 2.4 m **or** 5.0 m
- carrying strap
- Elpress handle straight





Accessories

Name	Net weight (kg)	Note	Pcs/ pack
HYD.SLANG KPL. 2,4M ERGO PS710E	2,40	Hydraulic hose (2.4 m) for PS710E, with ERGO handle	1
HYD.SLANG KPL. 5M ERGO PS710E	3,90	Hydraulic hose (5 m) for PS710E, 1 with ERGO handle	1
HYD.SLANG KPL. 2,4M RAK PS710E	2,5	Hydraulic hose (2,4 m) for PS710E, with straight handle	1
HYD.SLANG KPL. 5M RAK PS710E	4,0	Hydraulic hose (5 m) for PS710E, 1 with straight handle	1
HYD.SLANG KPL. 2,4M RAK PS710R	2,5	Hydraulic hose (2,4 m) for PS710E, with straight handle	1
HYD.SLANG KPL. 5M RAK PS710R	4,0	Hydraulic hose (5 m) for PS710E, 1 with straight handle	1
HYD.SLANG KPL. 2,4M ERGO PS710R	2,43	Hydraulic hose (2.4 m) for PS710R, with ERGO handle	1
HYD.SLANG KPL. 5M ERGO PS710R	4,0	Hydraulic hose (5 m) for PS710R, 1 with ERGO handle	1
FCU-PS710R	2,80	Foot pedal for PS710R	1
FCU-PS710D&E	2,80	Foot pedal for PS710D and PS710E	1
BÄRREM (strap) PS710	0,12	Carrying strap for all PS710 versions	1



Technical data PS710

- possibility to use different pressure ranges, 0-700 Bar
- oil flow at 20 bar: 0.6 litre/min (PS710D 1.2 litre/min)
- oil volume: 1.0 litre
- oil type: HYDREX MV 22 or similar
- crimps/battery charge: 120 crimps with Cu 150 mm²
- ambient temperature: -22 to 55°C
- mains operation 85-276VAC 50-60Hz
- Li-ion battery 28,8V, 3,0 Ah
- meet CE requirements: Safety of machinery 2006/42/EC, Electromagnetic compatibility 2014/30/EU, Low Voltage Directive 2014/35/EU, ROHS 2014/35/EU, WEEE 2012/19/EU
- weight approx. 12,4 kg
- compact dimensions 370 × 170 × 280 mm

The pump consists of three base versions, each with customisation options.

Standard solutions:

Name	Article No	Description
PS710E251	5204-008200	
PS710E		Pump E
Mains cable (Type C)		Mains cable
2,4 m PS710E ERGOCOM		Hydraulic hose
PS710EBP		Battery
PS710EBC		Charger
Strap		Strap
PS710E501	5204-008400	
PS710E		Pump E
Mains cable (Type C)		Mains cable
5 m PS710E ERGOCOM		Hydraulic hose
PS710EBP		Battery
PS710EBC		Charger
Strap		Strap
PS710E251-ERGO	5204-015200	
PS710E		Pump E
Mains cable (Type C)		Mains cable
2,4 m PS710E ERGO		Hydraulic hose
PS710EBP		Battery
PS710EBC		Charger
Strap		Strap
PS710E501-ERGO	5204-015300	
PS710E		Pump E
Mains cable (Type C)		Mains cable
5 m PS710E ERGO		Hydraulic hose
PS710EBP		Battery
PS710EBC		Charger
Strap		Strap
PS710E251-RAK	5204-015400	
PS710E		Pump E
Mains cable (Type C)		Mains cable
2,4 m PS710E RAK		Hydraulic hose with straight handle
PS710EBP		Battery
PS710EBC		Charger
Strap		Strap
PS710E501-RAK	5204-015500	
PS710E		Pump E
Mains cable (Type C)		Mains cable
5 m PS710E RAK		Hydraulic hose with straight handle
PS710EBP		Battery
PS710EBC		Charger
Strap		Strap
PS710R250	5204-008300	
PS710R		Pump R
Mains cable (Type C)		Mains cable
2,4 m PS710R ERGO		Hydraulic hose
Strap		Strap
PS710R500	5204-008500	
PS710R		Pump R
Mains cable (Type C)		Mains cable
5 m PS710R ERGO		Hydraulic hose
Strap		Strap

Name	Article No	Description
PS710E251-ERGO-WOBC	5204-014800	
PS710E		Pump E
Mains cable (Type C)		Mains cable
2,4 m PS710E ERGO		Hydraulic hose
Strap		Strap
PS710E501-ERGO-WOBC	5204-014900	
PS710E		Pump E
Mains cable (Type C)		Mains cable
5 m PS710E ERGO		Hydraulic hose
Strap		Strap
PS710E251-RAK-WOBC	5204-015000	
PS710E		Pump E
Mains cable (Type C)		Mains cable
2,4 m PS710E RAK		Hydraulic hose with straight handle
Strap		Strap
PS710E501-RAK-WOBC	5204-015100	
PS710E		Pump E
Mains cable (Type C)		Mains cable
5 m PS710E RAK		Hydraulic hose with straight handle
Strap		Strap
PS710R250-RAK	5204-015700	
PS710R		Pump R
Mains cable (Type C)		Mains cable
5 m PS710R RAK		Hydraulic hose with straight handle
Strap		Strap
PS710R500-RAK	5204-015800	
PS710R		Pump R
Mains cable (Type C)		Mains cable
5 m PS710R RAK		Hydraulic hose with straight handle
Strap		Strap

Battery powered cable cutter



PCT85

Boasting an 85 mm Ø cutting capacity for both copper and aluminum cables, the PCT85 offers great performance.

- This cable cutter features an ergonomic design for comfortable handling during prolonged use
- 85 mm Ø cutting capacity for both copper and aluminum cables
- The head can rotate 350 degrees and is equipped with a sturdy handle
- Left and right-hand use
- Ergonomic design and optimized position of centre of gravity
- OLED display showing battery percentage, cutting times, fault code and maintenance note
- Automatic retraction when cut is completed
- Comes in a case with Li-ion battery, 5,0 Ah, 18 V, as well as charger



PCT65

The PCT65 features a 65 mm Ø cutting capacity, delivering precise cuts.

- 65 mm Ø cutting capacity for both copper and aluminum cables
- The head can rotate 350 degrees and is equipped with a sturdy handle
- Left and right-hand use
- Ergonomic design and optimized position of centre of gravity
- OLED display showing battery percentage, cutting times, fault code and maintenance note
- Automatic retraction when cut is completed
- Comes in a case with Li-ion battery, 5,0 Ah, 18 V, as well as charger



PCT40

Compact yet powerful, the PCT40 offers a 40 mm Ø cutting capacity tailored for versatility.

- 40 mm Ø cutting capacity for both copper and aluminum cables (32 mm Ø cutting capacity for four-core Cu cables)
- The head can rotate 180 degrees
- Left and right-hand use
- Ergonomic design
- OLED display showing battery percentage, cutting times, fault code and maintenance note
- For extra safety, manual retraction to return the piston in case of an incorrect cut
- Comes in a case with Li-ion battery, 5,0 Ah, 18 V, as well as charger



Max Ø conductor	Name	Delivered
85	PCT85	
85	PCT85-WOBC	No battery and charger
85	PCT85-DB	2 batteries
65	PCT65	
65	PCT65-WOBC	No battery and charger
65	PCT65-DB	2 batteries
40	PCT40	
40	PCT40-WOBC	No battery and charger
40	PCT40-DB	2 batteries

Battery powered cable cutter



PKL54C

Electric cable cutter for cutting Cu and Al cable, max. cutting diameter 54 mm.

Properties:

- not intended for cutting steel
- comes in a bag with Li-ion battery, 14.4 V, as well as charger
- tool performs a scissor motion when cutting that provides an optimal cut surface
- built-in fuse as a surge protector
- CE-marked

Max ϕ conductor	Name	Net weight (kg)	Length mm	Width	Height	Delivered
54	PKL54C	8,60	338	220	120	With charger 230VAC
54	PKL54C-US	7,70	338	22	12	With charger 150VAC
54	PKL54C-WOBC	6,25	338	22	12	Without battery and charger

Cable cutter up to ϕ 50 mm



HKS50



Cable cutter for cutting cable up to approx. ϕ 50 mm.

Cutting tool for steel and Cu/Al cable with interchangeable blades. HKS50 is supplied with universal blade UFE1 for Al/Cu, FeAl line, flexible steel line and anchoring cables.

Comes in a sturdy textile bag with instructions for use and cleaning tool for threads.

Properties:

- scissor-motion for the cut surface on the cut cable
- single-handed operation facilitates installation
- reliable and proven ratchet function
- move blades easily and quickly by releasing two screws
- clearly marked usage area on the blades

Max ϕ conductor	Name	Net weight (kg)	Length	Width	Height
50	HKS50	1,44	350	185	60



Blade for HKS50

Max ϕ conductor	Name	Net weight (kg)
50	UFE2	0,130
50	UFE1	0,104
30	UFEB	0,111
50	UFE	0,104

Hydraulic cable cutters



KL2585

Hydraulic cable cutting head for copper and aluminum cable.

Properties:

- cuts up to 4 x 150 mm² Cu conductor and ø 85 mm Al, paper and plastic insulated conductors (there may be restrictions depending on the conductor's design and materials)
- cuts steel-reinforced cables, but not steel wire-reinforced cables
- used with foot pump P4000 or electrically powered pump PS710
- supplied in plywood box

mm ²	Max ø conductor	Name	Net weight (kg)	Length mm	Width	Height
630	85	KL2585	10,35	250	377	75



HKL40 and KL40

HKL40/KL40, HKL55/KL55, HKL85/KL85

A series of cable cutters covering almost all needs when cutting power cables and lines. The cutter heads (KL) are operated with one of Elpress' pumps, e.g. foot pump P4000 or pump PS710.

Max ø conductor	Name	Net weight (kg)	Length mm	Width	Height
40	HKL40	6,05	645	165	85
55	HKL55	4,13	560	140	55
85	HKL85	7,60	745	190	72
40	KL40	4,70	285	105	85
55	KL55	3,50	300	110	55
85	KL85	6,70	385	170	75

Technical Specifications

HKL40 / KL40 / HKL55 / KL55 / HKL85 / KL85

Hydraulic manual cutters	HKL40	HKL55	HKL85
Hydraulic cutting heads	KL40	KL55	KL85
Max. opening	ca ø40	ø55	ø85
Max. cutting force, KN	88	43	55
Max. cutting capacity, examples.			
copper cable	ca ø40	400 (500) mm ²	630 mm ²
Cu annealed solid conductor		ø20	
Cu rod	ca ø30		
Aluminium cable	ca ø40	3x240+95 mm ²	3x240+95 mm ² 630(800 mm ²)
Al annealed solid conductor		ø25	
ACSR	ø40		
Al bar	ca ø40		
Telephone cable		ø55	
Steel wire (<180daN/mm ²)	ø11		
Steel rod	ø18		

Does not cut steel wire reinforced cable.



HKL85 and KL85



Our story.

We shall be a leader in our market, through safe and sustainable quality products. Since 1959, we have had an ongoing process of getting better at everything we do. We want our customers to feel confident that our curiosity and passion give us a leading role in creating products that are sustainable and fit the requirements of the future regarding electrification. We strive for our employees to feel proud to be part of our business, which has a rich history but also aims for a developing future.

We know that you can't just fall back on history and experience; you also have to aim upwards and forwards to meet the demands of the future. Our head office is in Sweden, but we are present all over the world with the help of subsidiaries, authorized partners and distributors.

Over the years, we have developed System Elpress, which is a unique system where we focus on safety when it comes to using the right tool for the right connection. System Elpress is represented by Academy, Certification, Consultation and Service. We create security and sustainability in using our products and also to make it possible to create special solutions for our customers.





Certify your team with Elpress Academy.

Every year, we visit multiple companies around the world to educate and train their operators to ensure they have the right knowledge to carry out the crimping correctly. When you choose System Elpress for your crimping requirements we offer training containing both theoretical and practical exercises.

After a completed course, the operators will be awarded a certification. These individuals have demonstrated a skill level necessary to carry out the work in a safe and proper manner when working with crimping in advanced applications. We tailor the training based on your needs and what suits your organization.

Elpress AB · P.O. Box 186, SE-872 24 KRAMFORS, Sweden
Tel: +46 612-71 71 00
E-mail: sales@elpress.se | www.elpress.net

